

# FMN CONNECTOR

1.0mm pitch/Connectors for FFC

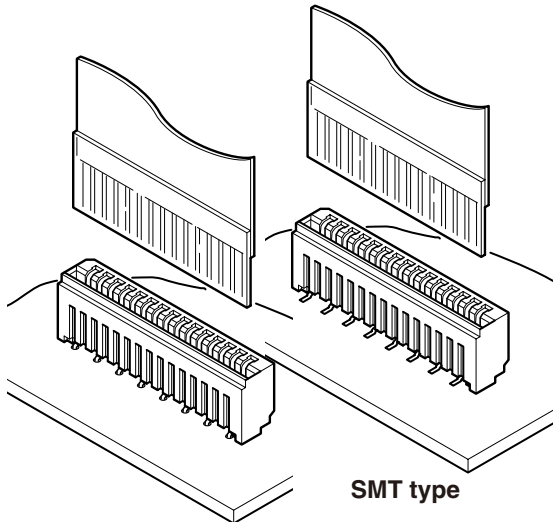

Through-hole type

SMT type

- Compact
- Low insertion force
- Both through-hole and SMT types are available
- Embossed tape for automatic mounting

## Specifications

- Current rating: 0.5A DC
- Voltage rating: 50V DC
- Temperature range: -25°C to +85°C  
(including temperature rise in applying electrical current)
- Contact resistance: Initial value/30m Ω max.  
After environmental testing/50m Ω max.
- Insulation resistance: 500M Ω min.
- Withstanding voltage: 500V AC/minute
- Applicable FFC: Conductor pitch/1.0mm  
Conductor width/0.7mm  
Mating part thickness/0.3±0.05mm
- Applicable PC board thickness: 1.6mm

Note: FFC to be actually used should be checked for applicability.

\* Compliant with RoHS.

\* Refer to "General Instruction and Notice when using Terminals and Connectors" at the end of this catalog.

\* Contact JST for details.

## Standards

Recognized E60389

Certified LR20812

## PC board layout (viewed from component side) and Assembly layout

### <Through-hole type>

#### Top entry type

##### Normal type

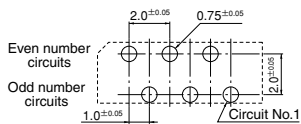

##### Reverse type

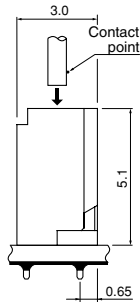
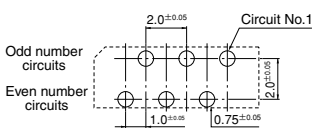

#### Side entry type

##### Normal type

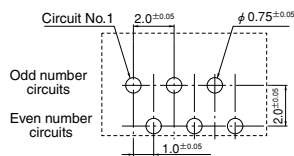

##### Reverse type

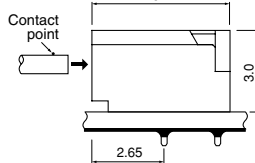
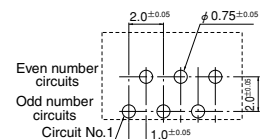

### <SMT type>

#### Top entry type

##### <In-line>

##### Normal type

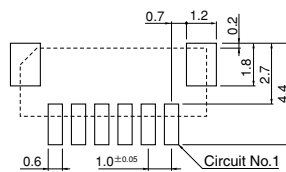

##### Reverse type

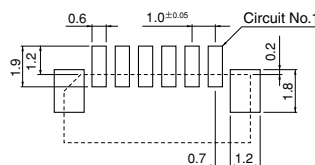

##### <Staggered>

##### Normal type

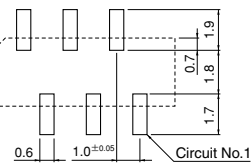

##### Reverse type

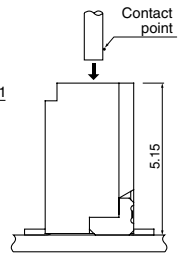
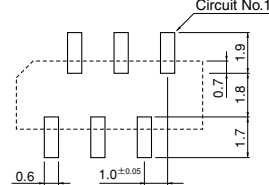

#### Side entry type

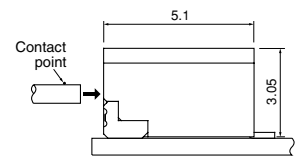
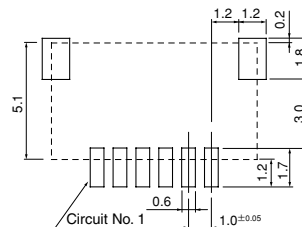

Note: 1. Tolerances are non-cumulative: ±0.05mm for all centers.  
2. Hole dimensions differ according to the kind of PC board and piercing method. The dimensions above should serve as a guideline. Contact JST for details.

Note: 1. Tolerances are non-cumulative: ±0.05mm for all centers.  
2. The dimensions above should serve as a guideline. Contact JST for details.

# FMN CONNECTOR

## Lead section dimensions of FFC

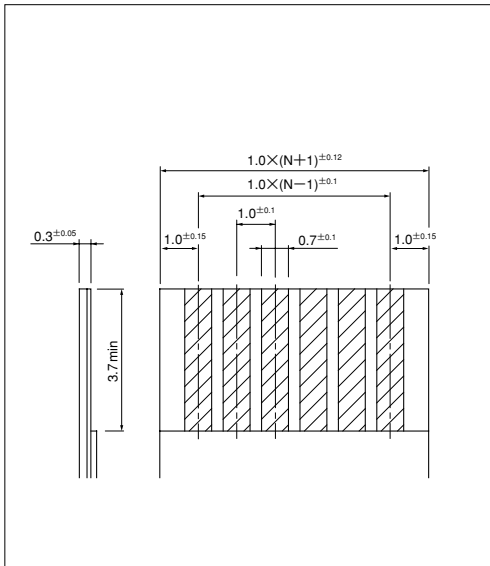

Note: N --- Number of circuits

## Through-hole type Connector

### Top entry type

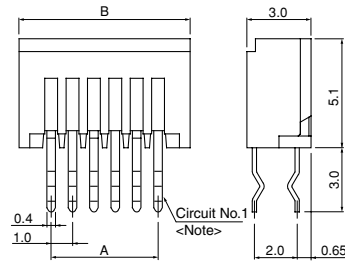

<Note> Normal type: The solder tail for circuit No.1 contact is positioned in front.  
Reverse type: The solder tail for circuit No.1 contact is positioned behind.

### Side entry type

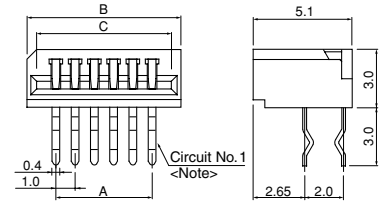

### Side entry type with stop

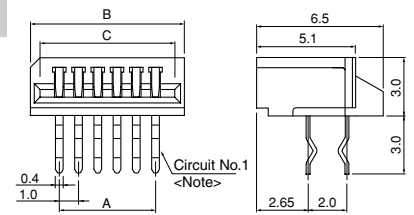

Circuits	Model No.						Dimensions (mm)			Q'ty / box		
	Top entry type		Side entry type		Side entry type with stop		A	B	C	Top entry type	Side entry type	Side entry type with stop
	Normal type	Reverse type	Normal type	Reverse type	Normal type	Reverse type						
4	04FMN-BTK-A	04FMN-BTRK-A	04FMN-STK-A	04FMN-STRK-A	04FMN-SSTK-A	04FMN-SSTRK-A	3.0	6.0	5.0	3,600	2,160	2,520
5	05FMN-BTK-A	05FMN-BTRK-A	05FMN-STK-A	05FMN-STRK-A	05FMN-SSTK-A	05FMN-SSTRK-A	4.0	7.0	6.0	3,100	1,860	2,170
6	06FMN-BTK-A	06FMN-BTRK-A	06FMN-STK-A	06FMN-STRK-A	06FMN-SSTK-A	06FMN-SSTRK-A	5.0	8.0	7.0	2,700	1,620	1,890
7	07FMN-BTK-A	07FMN-BTRK-A	07FMN-STK-A	07FMN-STRK-A	07FMN-SSTK-A	07FMN-SSTRK-A	6.0	9.0	8.0	2,400	1,440	1,680
8	08FMN-BTK-A	08FMN-BTRK-A	08FMN-STK-A	08FMN-STRK-A	08FMN-SSTK-A	08FMN-SSTRK-A	7.0	10.0	9.0	2,100	1,260	1,470
9	09FMN-BTK-A	09FMN-BTRK-A	09FMN-STK-A	09FMN-STRK-A	09FMN-SSTK-A	09FMN-SSTRK-A	8.0	11.0	10.0	1,900	1,140	1,330
10	10FMN-BTK-A	10FMN-BTRK-A	10FMN-STK-A	10FMN-STRK-A	10FMN-SSTK-A	10FMN-SSTRK-A	9.0	12.0	11.0	1,800	1,080	1,260
11	11FMN-BTK-A	11FMN-BTRK-A	11FMN-STK-A	11FMN-STRK-A	11FMN-SSTK-A	11FMN-SSTRK-A	10.0	13.0	12.0	1,600	960	1,120
12	12FMN-BTK-A	12FMN-BTRK-A	12FMN-STK-A	12FMN-STRK-A	12FMN-SSTK-A	12FMN-SSTRK-A	11.0	14.0	13.0	1,500	900	1,050
13	13FMN-BTK-A	13FMN-BTRK-A	13FMN-STK-A	13FMN-STRK-A	13FMN-SSTK-A	13FMN-SSTRK-A	12.0	15.0	14.0	1,400	840	980
14	14FMN-BTK-A	14FMN-BTRK-A	14FMN-STK-A	14FMN-STRK-A	14FMN-SSTK-A	14FMN-SSTRK-A	13.0	16.0	15.0	1,300	780	910
15	15FMN-BTK-A	15FMN-BTRK-A	15FMN-STK-A	15FMN-STRK-A	15FMN-SSTK-A	15FMN-SSTRK-A	14.0	17.0	16.0	1,200	720	840
16	16FMN-BTK-A	16FMN-BTRK-A	16FMN-STK-A	16FMN-STRK-A	16FMN-SSTK-A	16FMN-SSTRK-A	15.0	18.0	17.0	1,200	720	840
17	17FMN-BTK-A	17FMN-BTRK-A	17FMN-STK-A	17FMN-STRK-A	17FMN-SSTK-A	17FMN-SSTRK-A	16.0	19.0	18.0	1,100	660	770
18	18FMN-BTK-A	18FMN-BTRK-A	18FMN-STK-A	18FMN-STRK-A	18FMN-SSTK-A	18FMN-SSTRK-A	17.0	20.0	19.0	1,000	600	700
19	19FMN-BTK-A	19FMN-BTRK-A	19FMN-STK-A	19FMN-STRK-A	19FMN-SSTK-A	19FMN-SSTRK-A	18.0	21.0	20.0	1,000	600	700
20	20FMN-BTK-A	20FMN-BTRK-A	20FMN-STK-A	20FMN-STRK-A	20FMN-SSTK-A	20FMN-SSTRK-A	19.0	22.0	21.0	900	540	630
21	21FMN-BTK-A	21FMN-BTRK-A	21FMN-STK-A	21FMN-STRK-A	21FMN-SSTK-A	21FMN-SSTRK-A	20.0	23.0	22.0	900	540	630
22	22FMN-BTK-A	22FMN-BTRK-A	22FMN-STK-A	22FMN-STRK-A	22FMN-SSTK-A	22FMN-SSTRK-A	21.0	24.0	23.0	900	540	630
23	23FMN-BTK-A	23FMN-BTRK-A	23FMN-STK-A	23FMN-STRK-A	23FMN-SSTK-A	23FMN-SSTRK-A	22.0	25.0	24.0	800	480	560
24	24FMN-BTK-A	24FMN-BTRK-A	24FMN-STK-A	24FMN-STRK-A	24FMN-SSTK-A	24FMN-SSTRK-A	23.0	26.0	25.0	800	480	560
25	25FMN-BTK-A	25FMN-BTRK-A	25FMN-STK-A	25FMN-STRK-A	25FMN-SSTK-A	25FMN-SSTRK-A	24.0	27.0	26.0	800	480	560
26	26FMN-BTK-A	26FMN-BTRK-A	26FMN-STK-A	26FMN-STRK-A	26FMN-SSTK-A	26FMN-SSTRK-A	25.0	28.0	27.0	700	420	490
27	27FMN-BTK-A	27FMN-BTRK-A	27FMN-STK-A	27FMN-STRK-A	27FMN-SSTK-A	27FMN-SSTRK-A	26.0	29.0	28.0	700	420	490
28	28FMN-BTK-A	28FMN-BTRK-A	28FMN-STK-A	28FMN-STRK-A	28FMN-SSTK-A	28FMN-SSTRK-A	27.0	30.0	29.0	700	420	490
29	29FMN-BTK-A	29FMN-BTRK-A	29FMN-STK-A	29FMN-STRK-A	29FMN-SSTK-A	29FMN-SSTRK-A	28.0	31.0	30.0	700	420	490
30	30FMN-BTK-A	30FMN-BTRK-A	30FMN-STK-A	30FMN-STRK-A	30FMN-SSTK-A	30FMN-SSTRK-A	29.0	32.0	31.0	600	360	420
31	31FMN-BTK-A	31FMN-BTRK-A	31FMN-STK-A	31FMN-STRK-A	31FMN-SSTK-A	31FMN-SSTRK-A	30.0	33.0	32.0	600	360	420
32	32FMN-BTK-A	32FMN-BTRK-A	32FMN-STK-A	32FMN-STRK-A	32FMN-SSTK-A	32FMN-SSTRK-A	31.0	34.0	33.0	600	360	420
33	33FMN-BTK-A	33FMN-BTRK-A	33FMN-STK-A	33FMN-STRK-A	33FMN-SSTK-A	33FMN-SSTRK-A	32.0	35.0	34.0	600	360	420
34	34FMN-BTK-A	34FMN-BTRK-A	34FMN-STK-A	34FMN-STRK-A	34FMN-SSTK-A	34FMN-SSTRK-A	33.0	36.0	35.0	600	360	420
35	35FMN-BTK-A	35FMN-BTRK-A	35FMN-STK-A	35FMN-STRK-A	35FMN-SSTK-A	35FMN-SSTRK-A	34.0	37.0	36.0	500	300	350
36	36FMN-BTK-A	36FMN-BTRK-A	36FMN-STK-A	36FMN-STRK-A	36FMN-SSTK-A	36FMN-SSTRK-A	35.0	38.0	37.0	500	300	350
37	37FMN-BTK-A	37FMN-BTRK-A	37FMN-STK-A	37FMN-STRK-A	37FMN-SSTK-A	37FMN-SSTRK-A	36.0	39.0	38.0	500	300	350
38	38FMN-BTK-A	38FMN-BTRK-A	38FMN-STK-A	38FMN-STRK-A	38FMN-SSTK-A	38FMN-SSTRK-A	37.0	40.0	39.0	500	300	350
39	39FMN-BTK-A	39FMN-BTRK-A	39FMN-STK-A	39FMN-STRK-A	39FMN-SSTK-A	39FMN-SSTRK-A	38.0	41.0	40.0	500	300	350
40	40FMN-BTK-A	40FMN-BTRK-A	40FMN-STK-A	40FMN-STRK-A	40FMN-SSTK-A	40FMN-SSTRK-A	39.0	42.0	41.0	500	300	350

### Material and Finish

Contact: Phosphor bronze, copper-undercoated, tin-plated (reflow treatment)

Housing: 4 to 22 circuits/PBT, UL94V-0, Normal type...gray Reverse type...brown

23 to 40 circuits/PA 6T, UL94V-0, Normal type...gray Reverse type...black

RoHS compliance This product displays (LF)(SN) on a label.

# FMN CONNECTOR

## SMT type Connector

### Top entry type

### Side entry type

#### <In-line>

#### <Staggered>

#### Normal type

#### Reverse type

#### Normal type

#### Reverse type

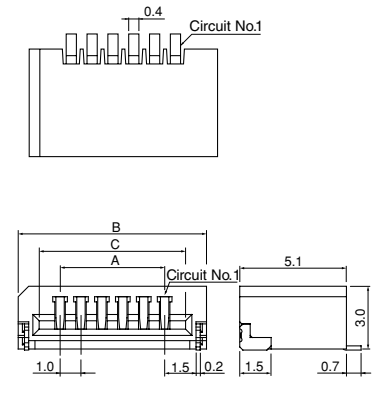
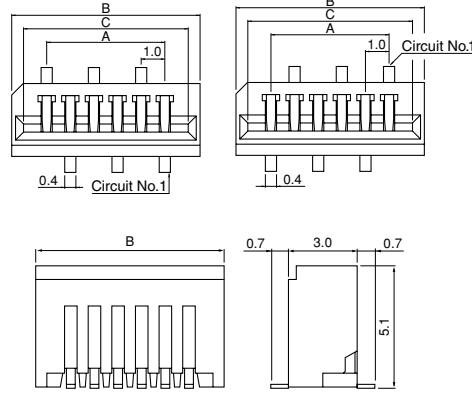
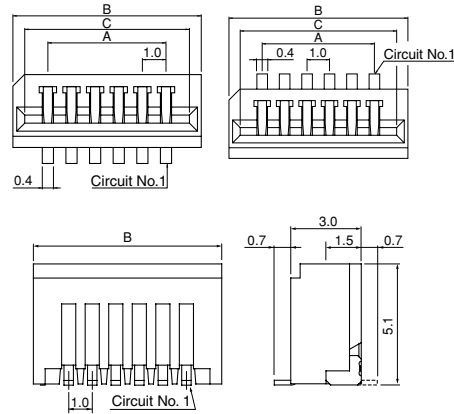

Circuits	Model No.				Dimensions (mm)			Q'ty / reel			
	Top entry type				Side entry type	B			Top entry type	Side entry type	
	Single-row		Staggered			Top entry type	Side entry type	C			
	Normal type	Reverse type	Normal type	Reverse type							
4	04FMN-BMT-A-TF	04FMN-BMTR-A-TB	04FMN-BMTTN-A-TF	04FMN-BMTTR-A-TB	04FMN-SMT-A-TF	3.0	6.0	7.0	5.0	1,000	2,000
5	05FMN-BMT-A-TF	05FMN-BMTR-A-TB	05FMN-BMTTN-A-TF	05FMN-BMTTR-A-TB	05FMN-SMT-A-TF	4.0	7.0	8.0	6.0	1,000	2,000
6	06FMN-BMT-A-TF	06FMN-BMTR-A-TB	06FMN-BMTTN-A-TF	06FMN-BMTTR-A-TB	06FMN-SMT-A-TF	5.0	8.0	9.0	7.0	1,000	2,000
7	07FMN-BMT-A-TF	07FMN-BMTR-A-TB	07FMN-BMTTN-A-TF	07FMN-BMTTR-A-TB	07FMN-SMT-A-TF	6.0	9.0	10.0	8.0	1,000	2,000
8	08FMN-BMT-A-TF	08FMN-BMTR-A-TB	08FMN-BMTTN-A-TF	08FMN-BMTTR-A-TB	08FMN-SMT-A-TF	7.0	10.0	11.0	9.0	1,000	2,000
9	09FMN-BMT-A-TF	09FMN-BMTR-A-TB	09FMN-BMTTN-A-TF	09FMN-BMTTR-A-TB	09FMN-SMT-A-TF	8.0	11.0	12.0	10.0	1,000	2,000
10	10FMN-BMT-A-TF	10FMN-BMTR-A-TB	10FMN-BMTTN-A-TF	10FMN-BMTTR-A-TB	10FMN-SMT-A-TF	9.0	12.0	13.0	11.0	1,000	2,000
11	11FMN-BMT-A-TF	11FMN-BMTR-A-TB	11FMN-BMTTN-A-TF	11FMN-BMTTR-A-TB	11FMN-SMT-A-TF	10.0	13.0	14.0	12.0	1,000	2,000
12	12FMN-BMT-A-TF	12FMN-BMTR-A-TB	12FMN-BMTTN-A-TF	12FMN-BMTTR-A-TB	12FMN-SMT-A-TF	11.0	14.0	15.0	13.0	1,000	2,000
13	13FMN-BMT-A-TF	13FMN-BMTR-A-TB	13FMN-BMTTN-A-TF	13FMN-BMTTR-A-TB	13FMN-SMT-A-TF	12.0	15.0	16.0	14.0	1,000	2,000
14	14FMN-BMT-A-TF	14FMN-BMTR-A-TB	14FMN-BMTTN-A-TF	14FMN-BMTTR-A-TB	14FMN-SMT-A-TF	13.0	16.0	17.0	15.0	1,000	2,000
15	15FMN-BMT-A-TF	15FMN-BMTR-A-TB	15FMN-BMTTN-A-TF	15FMN-BMTTR-A-TB	15FMN-SMT-A-TF	14.0	17.0	18.0	16.0	1,000	2,000
16	16FMN-BMT-A-TF	16FMN-BMTR-A-TB	16FMN-BMTTN-A-TF	16FMN-BMTTR-A-TB	16FMN-SMT-A-TF	15.0	18.0	19.0	17.0	1,000	2,000
17	17FMN-BMT-A-TF	17FMN-BMTR-A-TB	17FMN-BMTTN-A-TF	17FMN-BMTTR-A-TB	17FMN-SMT-A-TF	16.0	19.0	20.0	18.0	1,000	2,000
18	18FMN-BMT-A-TF	18FMN-BMTR-A-TB	18FMN-BMTTN-A-TF	18FMN-BMTTR-A-TB	18FMN-SMT-A-TF	17.0	20.0	21.0	19.0	1,000	2,000
19	19FMN-BMT-A-TF	19FMN-BMTR-A-TB	19FMN-BMTTN-A-TF	19FMN-BMTTR-A-TB	19FMN-SMT-A-TF	18.0	21.0	22.0	20.0	1,000	2,000
20	20FMN-BMT-A-TF	20FMN-BMTR-A-TB	20FMN-BMTTN-A-TF	20FMN-BMTTR-A-TB	20FMN-SMT-A-TF	19.0	22.0	23.0	21.0	1,000	2,000
21	21FMN-BMT-A-TF	21FMN-BMTR-A-TB	21FMN-BMTTN-A-TF	21FMN-BMTTR-A-TB	21FMN-SMT-A-TF	20.0	23.0	24.0	22.0	1,000	2,000
22	22FMN-BMT-A-TF	22FMN-BMTR-A-TB	22FMN-BMTTN-A-TF	22FMN-BMTTR-A-TB	22FMN-SMT-A-TF	21.0	24.0	25.0	23.0	1,000	2,000
23	23FMN-BMT-A-TF	23FMN-BMTR-A-TB	23FMN-BMTTN-A-TF	23FMN-BMTTR-A-TB	23FMN-SMT-A-TF	22.0	25.0	26.0	24.0	1,000	2,000
24	24FMN-BMT-A-TF	24FMN-BMTR-A-TB	24FMN-BMTTN-A-TF	24FMN-BMTTR-A-TB	24FMN-SMT-A-TF	23.0	26.0	27.0	25.0	1,000	2,000
25	25FMN-BMT-A-TF	25FMN-BMTR-A-TB	25FMN-BMTTN-A-TF	25FMN-BMTTR-A-TB	25FMN-SMT-A-TF	24.0	27.0	28.0	26.0	1,000	2,000
26	26FMN-BMT-A-TF	26FMN-BMTR-A-TB	26FMN-BMTTN-A-TF	26FMN-BMTTR-A-TB	26FMN-SMT-A-TF	25.0	28.0	29.0	27.0	1,000	2,000
27	27FMN-BMT-A-TF	27FMN-BMTR-A-TB	27FMN-BMTTN-A-TF	27FMN-BMTTR-A-TB	27FMN-SMT-A-TF	26.0	29.0	30.0	28.0	1,000	2,000
28	28FMN-BMT-A-TF	28FMN-BMTR-A-TB	28FMN-BMTTN-A-TF	28FMN-BMTTR-A-TB	28FMN-SMT-A-TF	27.0	30.0	31.0	29.0	1,000	2,000
29	29FMN-BMT-A-TF	29FMN-BMTR-A-TB	29FMN-BMTTN-A-TF	29FMN-BMTTR-A-TB	29FMN-SMT-A-TF	28.0	31.0	32.0	30.0	1,000	2,000
30	30FMN-BMT-A-TF	30FMN-BMTR-A-TB	30FMN-BMTTN-A-TF	30FMN-BMTTR-A-TB	30FMN-SMT-A-TF	29.0	32.0	33.0	31.0	1,000	2,000
31	31FMN-BMT-A-TF	31FMN-BMTR-A-TB	31FMN-BMTTN-A-TF	31FMN-BMTTR-A-TB	31FMN-SMT-A-TF	30.0	33.0	34.0	32.0	1,000	2,000
32	32FMN-BMT-A-TF	32FMN-BMTR-A-TB	32FMN-BMTTN-A-TF	32FMN-BMTTR-A-TB	32FMN-SMT-A-TF	31.0	34.0	35.0	33.0	1,000	2,000
33	33FMN-BMT-A-TF	33FMN-BMTR-A-TB	33FMN-BMTTN-A-TF	33FMN-BMTTR-A-TB	33FMN-SMT-A-TF	32.0	35.0	36.0	34.0	1,000	2,000
34	34FMN-BMT-A-TF	34FMN-BMTR-A-TB	34FMN-BMTTN-A-TF	34FMN-BMTTR-A-TB	34FMN-SMT-A-TF	33.0	36.0	37.0	35.0	1,000	2,000
35	35FMN-BMT-A-TF	35FMN-BMTR-A-TB	35FMN-BMTTN-A-TF	35FMN-BMTTR-A-TB	35FMN-SMT-A-TF	34.0	37.0	38.0	36.0	1,000	2,000
36	36FMN-BMT-A-TF	36FMN-BMTR-A-TB	36FMN-BMTTN-A-TF	36FMN-BMTTR-A-TB	36FMN-SMT-A-TF	35.0	38.0	39.0	37.0	1,000	2,000
37	37FMN-BMT-A-TF	37FMN-BMTR-A-TB	37FMN-BMTTN-A-TF	37FMN-BMTTR-A-TB	37FMN-SMT-A-TF	36.0	39.0	40.0	38.0	1,000	2,000
38	38FMN-BMT-A-TF	38FMN-BMTR-A-TB	38FMN-BMTTN-A-TF	38FMN-BMTTR-A-TB	38FMN-SMT-A-TF	37.0	40.0	41.0	39.0	1,000	2,000
39	39FMN-BMT-A-TF	39FMN-BMTR-A-TB	39FMN-BMTTN-A-TF	39FMN-BMTTR-A-TB	39FMN-SMT-A-TF	38.0	41.0	42.0	40.0	1,000	2,000
40	40FMN-BMT-A-TF	40FMN-BMTR-A-TB	40FMN-BMTTN-A-TF	40FMN-BMTTR-A-TB	40FMN-SMT-A-TF	39.0	42.0	43.0	41.0	1,000	2,000

#### Material and Finish

Contact: Phosphor bronze, copper-undercoated, tin-plated (reflow treatment)  
Housing: PA 6T, UL94V-0, black  
Solder tab: Brass, copper-undercoated, tin-plated (reflow treatment)

**RoHS compliance** This product displays (LF)(SN) on a label.

Note: 1. The products listed above are supplied on embossed tape.  
2. Contact JST for the top entry type headers with suction cap.