

Features

- $S_{21} = 34 \text{ dB@950 MHz}$
= 31 dB@1250 MHz
- NF of 0.75 dB over Frequency
- Unconditionally Stable
- Single 5 V Supply
- High OIP3@Low Current

Description

The plerow™ ALN-series is the compactly designed surface-mount module for the use of the LNA with or without the following gain blocks in the infrastructure equipment of the mobile wireless (CDMA, GSM, PCS, PHS, WCDMA, DMB, WLAN, WiBro, WiMAX), GPS, satellite communication terminals, CATV and so on. It has an exceptional performance of low noise figure, high gain, high OIP3, and low bias current. The stability factor is always kept more than unity over the application band in order to ensure its unconditionally stable implementation to the application system environment. The surface-mount module package including the completed matching circuit and other components necessary just in case allows very simple and convenient implementation onto the system board in mass production level.

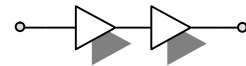

2-stage Single Type

Specifications (in Production)

Typ.@T = 25 °C, $V_s = 5 \text{ V}$, Freq. = 1100 MHz, $Z_{o,sys} = 50 \text{ ohms}$

Parameter	Unit	Specifications		
		Min	Typ	Max
Frequency Range	MHz	950		1250
Gain	dB	31.5	32.5	
Gain Flatness	dB		± 1.5	± 1.6
Noise Figure	dB		0.75	0.8
Output IP3 ⁽¹⁾	dBm	31	32	
S11/S22 ⁽²⁾	dB			-12/-14
Output P1dB	dBm	19	20	
Switching Time ⁽³⁾	μsec		-	
Supply Current	mA		100	120
Supply Voltage	V		5	
Impedance	Ω		50	
Max. RF Input Power	dBm	C.W 29~31 (before fail)		
Package Type & Size	mm	Surface Mount Type, 10Wx10Lx3.8H		

More Information

Website: www.asb.co.kr
E-mail: sales@asb.co.kr

Tel: (82) 42-528-7223
Fax: (82) 42-528-7222

Operating temperature is $-40 \text{ }^\circ\text{C}$ to $+85 \text{ }^\circ\text{C}$.

1) OIP3 is measured with two tones at an output power of 4 dBm/tone separated by 1 MHz.

2) S11, S22 (max) is the worst value within the frequency band.

3) Switching time means the time that takes for output power to get stabilized to its final level after switching DC voltage from 0 V to V_s .

Outline Drawing (Unit: mm)

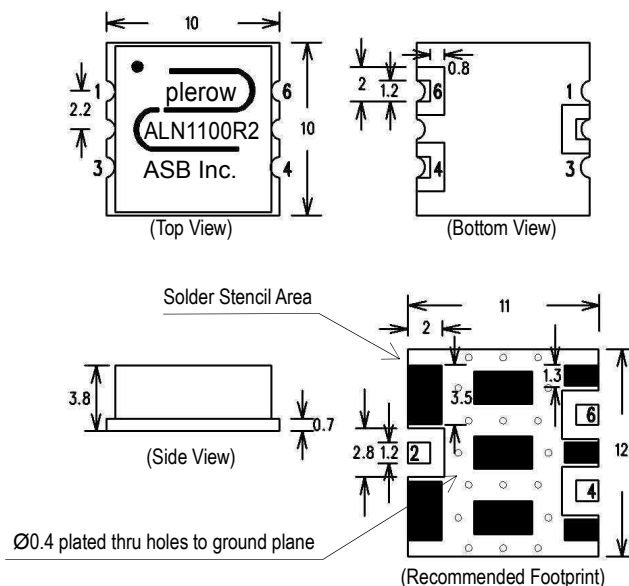

Pin Number	Function
2	RF In
4	V_s
6	RF Out
Others	Ground

Note: 1. The number and size of ground via holes in a circuit board is critical for thermal RF grounding considerations.

2. We recommend that the ground via holes be placed on the bottom of all ground pins for better RF and thermal performance, as shown in the drawing at the left side.

**Typical Performance
(Measured)**

950~1250 MHz

+5 V

S-parameters

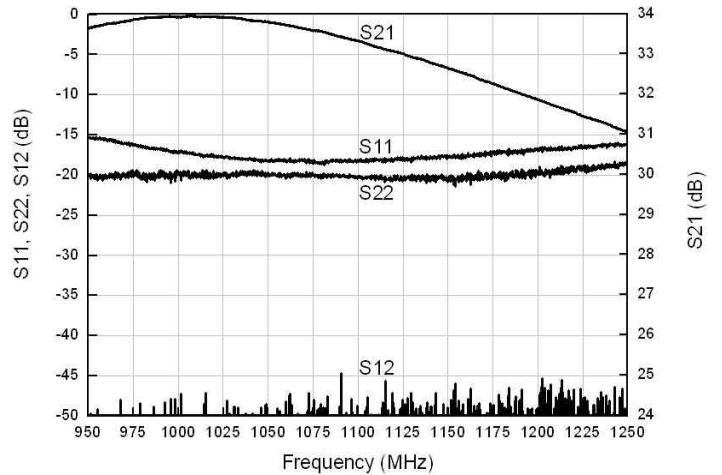

Stability Factor (K)

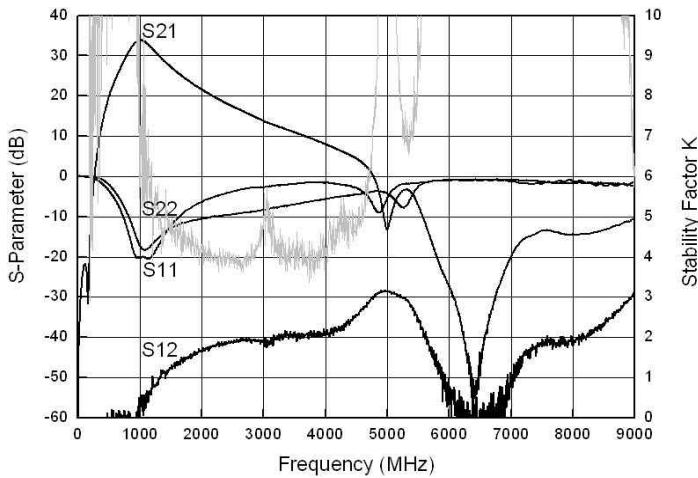

Noise Figure

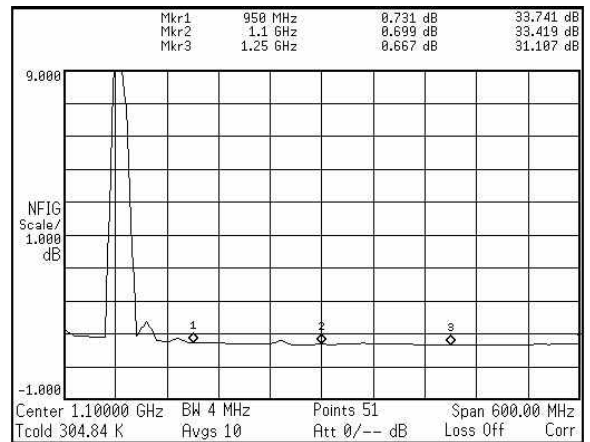

OIP3

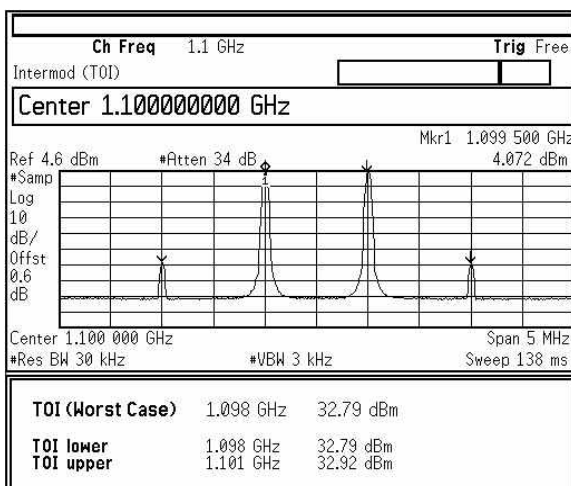

P1dB

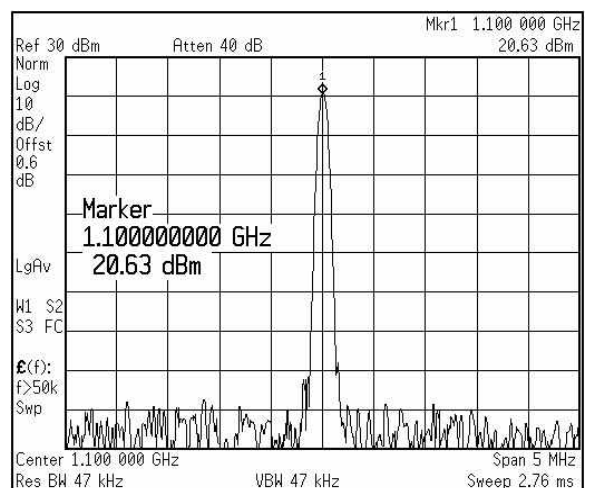

RF Performance with Voltage Change

1. S-parameter

	950 MHz			1100 MHz				1250 MHz		
	S21 (dB)	S11 (dB)	S22 (dB)	S21 (dB)	G/F (dB)	S11 (dB)	S22 (dB)	S21 (dB)	S11 (dB)	S22 (dB)
4.50 V	33.03	-16.25	-19.85	32.71	2.42	-20.18	-26.95	30.61	-17.57	-20.54
4.75 V	33.26	-16.18	-19.94	32.96	2.41	-20.70	-27.04	30.85	-18.02	-20.74
5.00 V	33.42	-16.00	-20.23	33.13	2.41	-21.11	-26.93	31.01	-18.27	-20.89
5.25 V	33.54	-15.99	-20.95	33.23	2.45	-21.36	-26.35	31.09	-18.50	-21.07
5.50 V	33.53	-15.90	-21.71	33.28	2.40	-21.73	-25.59	31.13	-18.78	-21.03

2. OIP3, P1dB & NF

	950 MHz			1100 MHz			1250 MHz		
	OIP3 (dBm)	P1dB (dBm)	NF (dB)	OIP3 (dBm)	P1dB (dBm)	NF (dB)	OIP3 (dBm)	P1dB (dBm)	NF (dB)
4.50 V	32.70	20.32	0.693	32.38	20.57	0.646	31.05	19.43	0.612
4.75 V	33.34	21.00	0.702	33.45	21.17	0.650	32.15	20.39	0.614
5.00 V	34.61	21.55	0.708	34.23	21.76	0.652	33.02	21.08	0.614
5.25 V	34.62	21.97	0.707	34.18	22.18	0.663	33.05	21.52	0.617
5.50 V	34.68	22.43	0.710	34.15	22.54	0.672	33.12	21.87	0.626

Note: tested at room temperature.

RF Performance with Operating Temperature

1. S-parameter

	950 MHz			1100 MHz				1250 MHz		
	S21 (dB)	S11 (dB)	S22 (dB)	S21 (dB)	G/F (dB)	S11 (dB)	S22 (dB)	S21 (dB)	S11 (dB)	S22 (dB)
-45 °C	34.65	-12.54	-16.47	34.70	2.34	-16.42	-29.72	32.31	-15.43	-21.40
-10 °C	34.23	-14.38	-17.83	34.12	2.23	-19.22	-27.89	32.00	-17.50	-21.04
25 °C	33.67	-15.30	-19.72	33.48	2.33	-20.61	-28.56	31.34	-18.17	-21.32
60 °C	33.35	-16.65	-21.54	32.98	2.46	-20.77	-27.32	30.89	-17.75	-20.90
85 °C	32.85	-17.75	-23.53	32.38	2.58	-20.00	-26.22	30.27	-16.89	-20.13

2. OIP3, P1dB & NF

	950 MHz			1100 MHz			1250 MHz		
	OIP3 (dBm)	P1dB (dBm)	NF (dB)	OIP3 (dBm)	P1dB (dBm)	NF (dB)	OIP3 (dBm)	P1dB (dBm)	NF (dB)
-45 °C	35.73	22.55	0.427	35.50	22.61	0.389	34.45	22.03	0.345
-10 °C	35.45	22.51	0.558	35.10	22.78	0.502	34.05	21.87	0.475
25 °C	34.75	21.75	0.710	34.20	22.00	0.658	33.12	21.15	0.625
60 °C	33.87	21.32	0.890	33.12	20.72	0.820	32.20	20.20	0.801
85 °C	32.40	20.28	0.941	31.82	20.25	0.877	31.65	19.85	0.853

Note: tested at $V_s = 5V$.

Application Circuit

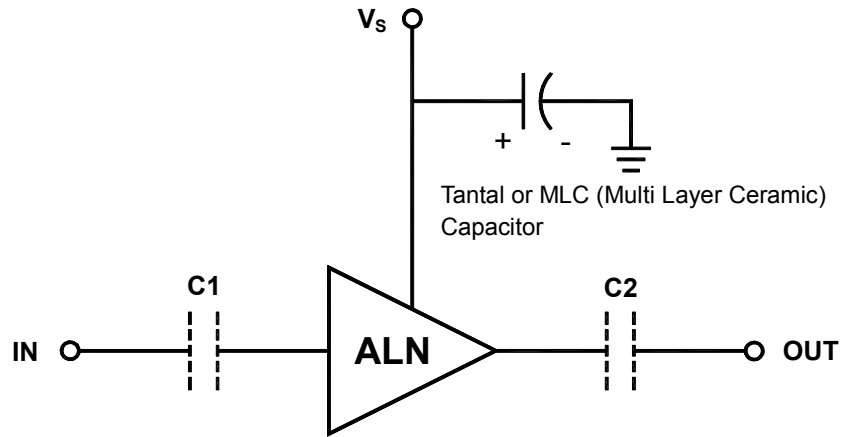

- 1) The tantalum or MLC (Multi Layer Ceramic) capacitor is optional and for bypassing the AC noise introduced from the DC supply. The capacitance value may be determined by customer's DC supply status. The capacitor should be placed as close as possible to V_s pin and be connected directly to the ground plane for the best electrical performance.
- 2) DC blocking capacitors are always necessarily placed at the input and output port for allowing only the RF signal to pass and blocking the DC component in the signal. The DC blocking capacitors are included inside the ALN module. Therefore, C1 & C2 capacitors may not be necessary, but can be added just in case that the customer wants. The value of C1 & C2 is determined by considering the application frequency.

Recommended Soldering Reflow Process

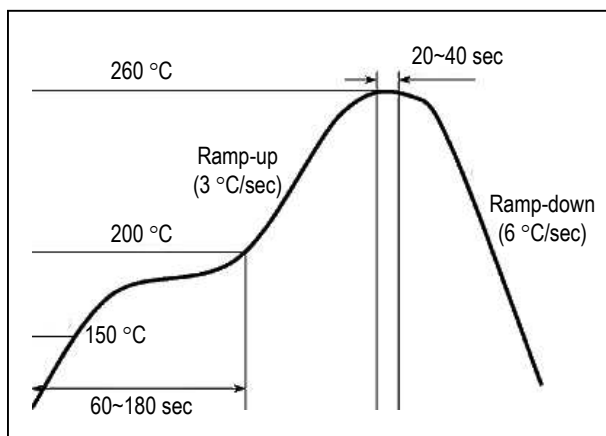

Evaluation Board Layout

