

OUTLINE

R3132x/R3133x Series are CMOS-based low voltage detector ICs with built-in delay circuit, high detector threshold accuracy, and ultra low supply current, which can operate at low voltage.

These ICs can be used as system reset generators, and each of these ICs consists of a voltage reference, a comparator, resistors for setting voltage detector threshold, an output driver transistor, manual reset circuit, and an output delay generator.

Detector threshold is fixed internally with high accuracy and requires no adjustment. When a supply voltage crosses a setting detector threshold voltage from a high value to a lower value, this IC generates reset signal.

R3132x Series output "L" at its detect, while R3133x Series output "H".

Since each of R3132x/R3133x Series embeds an output delay generator, during a setting 240ms delay time, which is fixed in the IC, this IC keeps the reset condition after they are released. Released conditions are the case when a supply voltage crosses a setting detector threshold voltage from a low value to a higher value, or when this IC is released from manual reset.

Two output types, Nch open drain type and CMOS type, are available.

Since the package for these ICs are ultra small SC-82AB package and SON1612-6, high density mounting of the ICs on board is possible.

FEATURES

- Ultra-low supply current Typ. 0.8 μ A (R313xx27x: $V_{DD}=3.0V$)
- Operating Voltage Range..... 0.8V to 6.0V ($T_{opt}=25^{\circ}C$)
- Detector Threshold..... Setting with a step of 0.1V in the range of 1.0V to 5.0V is possible. Further, 2.32V, 2.63V, 2.93V, 3.08V, 4.38V, and 4.63V can be provided as standard.
- Embedded Power on Reset Delay Time Circuit..... Typ. 240ms
- High Accuracy Detector Threshold $\pm 2.0\%$
- High Accuracy Released Delay Time..... $\pm 15.0\%$
- Low Temperature-Drift Coefficient of Detector Threshold..... Typ. $\pm 100ppm/^{\circ}C$
- Two Output Types Nch Open Drain and CMOS
- Small Packages SC-82AB, SON1612-6

APPLICATIONS

- CPU & Logic Circuit Reset
- Battery Checker
- Window Comparator
- Wave Shaping Circuit
- Battery Backup Circuit
- Power Failure Detector

BLOCK DIAGRAMS

R3132xxxEA Nch Open Drain Output

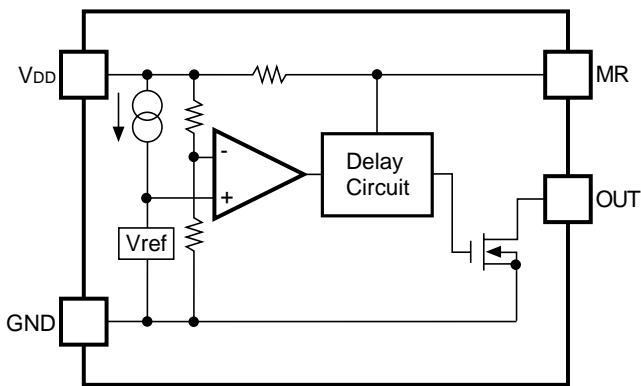

R3132xxxEC CMOS Output

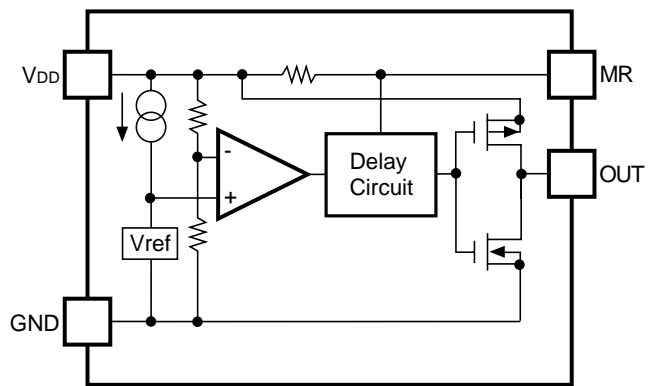

R3133xxxEA Nch Open Drain Output

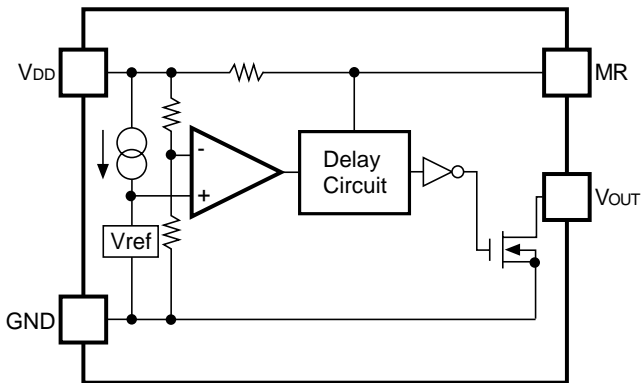

R3133xxxEC CMOS Output

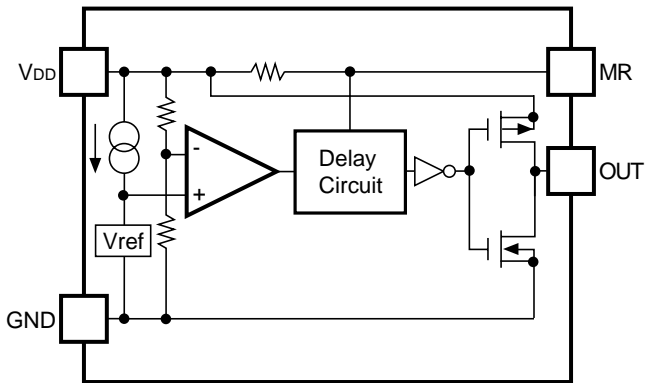

TIMING CHART

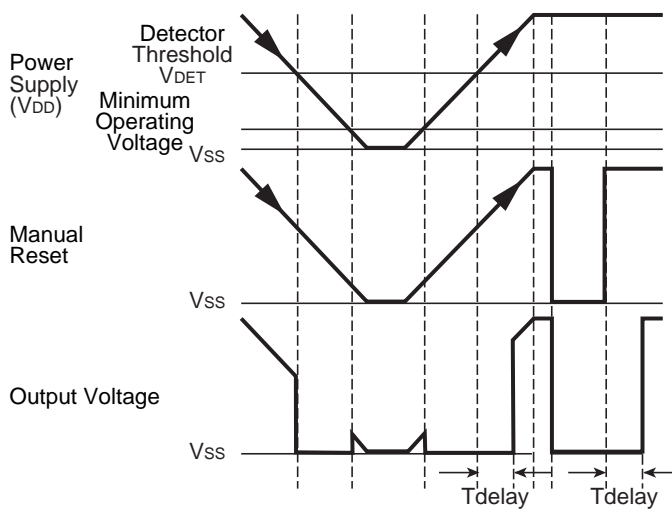

R3132x Operation Diagram

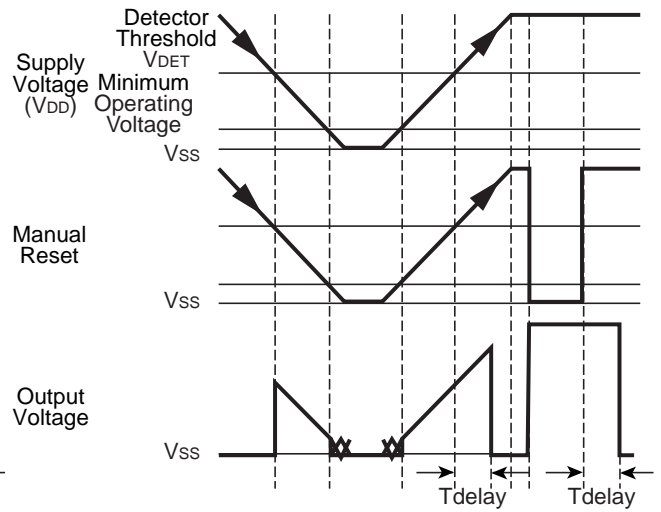

R3133x Operation Diagram

• Output Delay Operation

Output Delay Time, or T_{delay} is specified as follows:

1. In the case of Nch Open Drain Output:

The time interval from rising edge of V_{DD} pulse (0.8V→(V_{DET})+1.0V) to the time at which the output reaches 2.5V under the condition that the output pin (OUT) is pulled up to 5V through a 470kΩ resistor.

2. In the case of CMOS Output:

The time interval from rising edge of V_{DD} pulse (0.8V→(V_{DET})+1.0V) to the time at the output reaches V_{DD}/2.

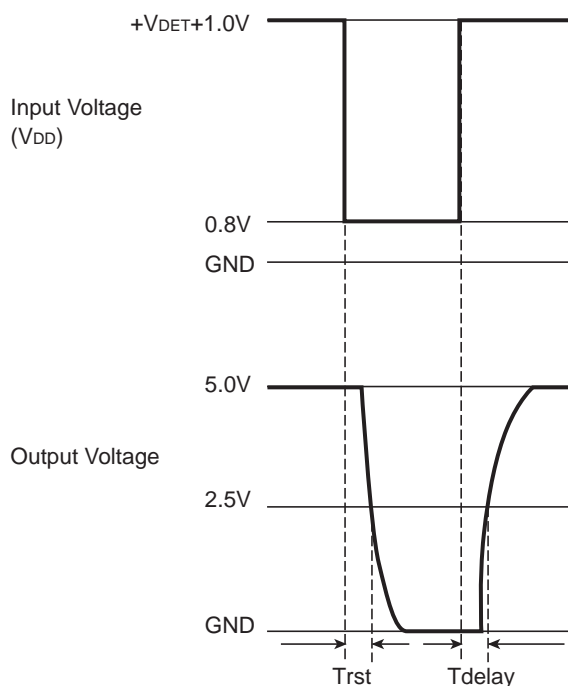

Nch Open Drain Output

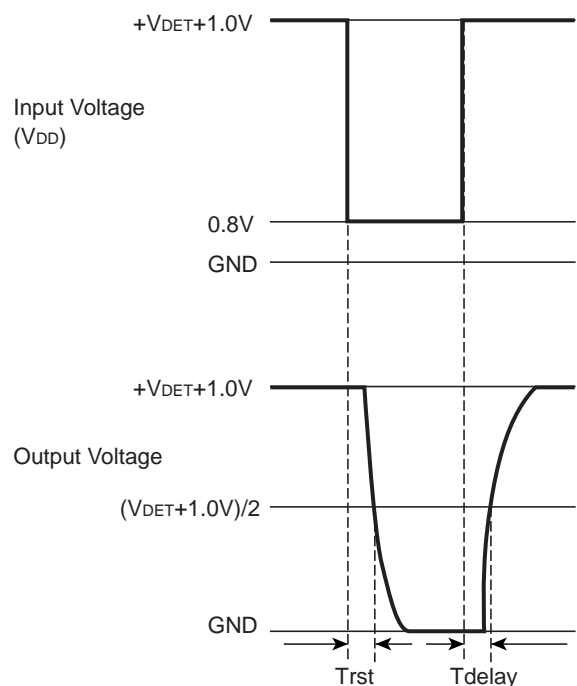

CMOS Output

SELECTION GUIDE

The detector threshold and the output type of R3132x/R3133x Series can be designated at the user's request by specifying the part number as follows:

R3132xxxEx (x)-xx-x ←Part Number
 R3133xxxEx (x)-xx-x
 ↑ ↑ ↑ ↑ ↑ ↑
 a b c b' d e

Code	Contents
a	Package Designation Q: SC-82AB D: SON1612-6
b/b'	Setting Detector Threshold (V_{DET}) Stepwise setting with a step of 0.1V in the range of 1.0V to 5.0V is possible. a' describes the last digit of the next items; 2.32V/2.63V/2.93V/3.08V/4.63V ex. 2.63V Output → R313xx26Ex3-TR
c	Designation of Output type A: Nch Open Drain C: CMOS
d	TR: Designation of Taping Direction (Refer to Taping Specification)
e	Designation of Composition of pin plating -F: Lead free solder plating (SC-82AB, SON1612-6)

PIN CONFIGURATION

● SC-82AB

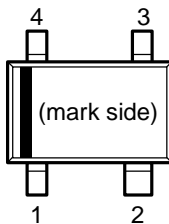

● SON1612-6

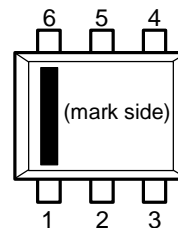

PIN DESCRIPTION

• SC-82AB

Pin No.	Symbol	Description
1	GND	Ground Pin
2	OUT	Output Pin R3132Q Series: Output "L" at detect, Output "H" at release. R3133Q Series: Output "H" at detect, Output "L" at release.
3	MR	Manual Reset Input Pin Active at "L" input. Pulled up via 1MΩ. If MR pin is not necessary, open this node, or connect to V _{DD} .
4	V _{DD}	Input Pin

• SON1612-6

Pin No.	Symbol	Description
1	V _{DD}	Input Pin
2	GND	Ground Pin
3	MR	Manual Reset Input Pin Active at "L" input. Pulled up via 1MΩ. If MR pin is not necessary, open this node, or connect to V _{DD} .
4	OUT	Output Pin R3132D Series: Output "L" at detect, Output "H" at release. R3133D Series: Output "H" at detect, Output "L" at release.
5	GND	Ground Pin
6	NC	No Connection

ABSOLUTE MAXIMUM RATINGS

Symbol	Item	Rating	Unit
V _{DD}	Supply Voltage	6.5	V
V _{OUT}	Output Voltage	CMOS V _{SS} -0.3 to V _{DD} +0.3	V
		Nch V _{SS} -0.3 to 6.5	V
V _{MR}	Input Voltage	V _{SS} -0.3 to V _{DD} +0.3	V
I _{OUT}	Output Current	20	mA
P _D	Power Dissipation	150(SC-82AB)	mW
		500(SON1612-6) ^{*Note1}	
T _{opt}	Operating Temperature Range	-40 to +85	°C
T _{stg}	Storage Temperature Range	-55 to +125	°C
T _{solder}	Soldering Temperature	260°C, 10s	

*Note 1: This specification is at mounted on board.

P_D depends on conditions of mounting on board. This specification is based on the measurement at the condition below:

*Measurement Conditions

Environment: Mounted on board (Wind velocity 0m/s)

Board Material: FR-4 (2-layer)

Board dimensions : 40mm x 40mm x t1.6mm

Copper Area : 50%

ABSOLUTE MAXIMUM RATINGS

Absolute Maximum Ratings are threshold limit values that must not be exceeded even for a moment under any conditions. Moreover, such values for any items must not be reached simultaneously. Operation above these absolute maximum ratings may cause degradation or permanent damage to the device. These are just stress ratings and do not necessarily imply to guarantee operation below these limits.

ELECTRICAL CHARACTERISTICS

T_{opt}=25°C

Symbol	Item	Test Conditions		Min.	Typ.	Max.	Unit
V _{DD}	Operating Voltage	R3132	T _{opt} =25°C	0.75		6.00	V
			-40°C ≤ T _{opt} ≤ 85°C	0.85		6.00	
		R3133	T _{opt} =25°C	0.80		6.00	
			-40°C ≤ T _{opt} ≤ 85°C	0.90		6.00	
V _{DET}	Detector Threshold			V _{DET} × 0.98		V _{DET} × 1.02	V
I _{SS1}	Supply Current1	V _{DD} =V _{DET} -0.1V, I _{OUT} =0A				2.0	μA
I _{SS2}	Supply Current2	V _{DD} =V _{DET} +0.1V, I _{OUT} =0A				2.0	μA
I _{SS3}	Supply Current3	V _{DET} <1.6V	V _{DD} =6.0V, I _{OUT} =0A			3.6	μA
		1.6V ≤ V _{DET} <2.7V				3.0	
		2.7V ≤ V _{DET}				2.5	
V _{OH}	“H” Output Voltage	Refer to the specification table below.					V
V _{OL}	“L” Output Voltage	Refer to the specification table below.					V
R _{MR}	MR pin pull-up resistance	T _{opt} =25°C		0.5	1.0	4.0	MΩ
T _{rst} *Note1	Output Delay Time for detect	V _{DD} =V _{DET} to V _{DET} -0.1V			15		μs
T _{delay} (*2)	Output Delay Time for release	V _{DD} =0.8V to V _{DET} +1.0V		204	240	276	ms
$\frac{\Delta V_{DET}}{\Delta T_{opt}}$	Detector Threshold Temperature Coefficient	-40°C ≤ T _{opt} ≤ 85°C			±100		ppm/ °C

Note1) Guaranteed by design, not mass production tested.

• “H” Output Voltage (V_{OH}) table

$T_{opt}=25^{\circ}\text{C}$

Products	Test Conditions		Min.	Typ.	Max.	Unit
R3132xxx1C	$V_{DET}<1.2\text{V}$	$V_{DD}=V_{DET}+0.1\text{V}$, $I_{OH}=-50\mu\text{A}$	$0.8\times V_{DD}$			V
	$1.2\text{V}\leq V_{DET}<2.0\text{V}$	$V_{DD}=V_{DET}+0.1\text{V}$, $I_{OH}=-150\mu\text{A}$				
	$2.0\text{V}\leq V_{DET}<3.1\text{V}$	$V_{DD}=V_{DET}+0.1\text{V}$, $I_{OH}=-500\mu\text{A}$				
	$3.1\text{V}\leq V_{DET}$	$V_{DD}=V_{DET}+0.1\text{V}$, $I_{OH}=-800\mu\text{A}$				
R3133xxx1C	$V_{DET}<1.2\text{V}$	$V_{DD}=V_{DET}-0.1\text{V}$, $I_{OH}=-10\mu\text{A}$	$0.8\times V_{DD}$			V
	$1.2\text{V}\leq V_{DET}<2.0\text{V}$	$V_{DD}=V_{DET}-0.1\text{V}$, $I_{OH}=-100\mu\text{A}$				
	$2.0\text{V}\leq V_{DET}<3.1\text{V}$	$V_{DD}=V_{DET}-0.1\text{V}$, $I_{OH}=-500\mu\text{A}$				
	$3.1\text{V}\leq V_{DET}$	$V_{DD}=V_{DET}-0.1\text{V}$, $I_{OH}=-800\mu\text{A}$				

• “L” Output Voltage (V_{OL}) table

$T_{opt}=25^{\circ}\text{C}$

Symbol	Item	Test Conditions	Min.	Typ.	Max.	Unit
R3132xxx1x	$V_{DET}<1.2\text{V}$	$V_{DD}=V_{DET}-0.1\text{V}$, $I_{OL}=20\mu\text{A}$			0.3	V
	$1.2\text{V}\leq V_{DET}<2.0\text{V}$	$V_{DD}=V_{DET}+0.1\text{V}$, $I_{OL}=750\mu\text{A}$				
	$2.0\text{V}\leq V_{DET}<3.1\text{V}$	$V_{DD}=V_{DET}+0.1\text{V}$, $I_{OL}=1.2\text{mA}$			0.4	V
	$3.1\text{V}\leq V_{DET}$	$V_{DD}=V_{DET}+0.1\text{V}$, $I_{OL}=3.2\text{mA}$				
R3133xxx1x	$V_{DET}<1.2\text{V}$	$V_{DD}=V_{DET}-0.1\text{V}$, $I_{OH}=20\mu\text{A}$			0.3	V
	$1.2\text{V}\leq V_{DET}<2.0\text{V}$	$V_{DD}=V_{DET}-0.1\text{V}$, $I_{OH}=750\mu\text{A}$				
	$2.0\text{V}\leq V_{DET}<3.1\text{V}$	$V_{DD}=V_{DET}-0.1\text{V}$, $I_{OH}=1.2\text{mA}$			0.4	V
	$3.1\text{V}\leq V_{DET}$	$V_{DD}=V_{DET}-0.1\text{V}$, $I_{OH}=3.2\text{mA}$				

DETECTOR THRESHOLD SPECIFICATIONS BY PART NUMBER

• R3132x

Part Number	Operating Voltage				Detector Threshold			Supply Current 1		
	V _{DD} [V]				-V _{DET} [V]			I _{SS1} [μA]		
	Conditions	Max.	Conditions	Max.	Min.	Typ.	Max.	Conditions	Typ.	Max.
R3132x23Ex2	T _{opt} =25°C	0.75	-40°C ≤ T _{opt} ≤ 85°C	0.85	2.274	2.320	2.366	V _{DD} =V _{DET} -0.1V I _{OUT} =0A	0.8	2.0
R3132x26Ex3					2.578	2.630	2.682			
R3132x29Ex3					2.872	2.930	2.988			
R3132x30Ex8					3.019	3.080	3.141			
R3132x43Ex8					4.293	4.380	4.467			
R3132x46Ex3					4.538	4.630	4.722			
R3132x10Ex	T _{opt} =25°C	0.75	-40°C ≤ T _{opt} ≤ 85°C	0.85	0.980	1.000	1.020	V _{DD} =V _{DET} -0.1V I _{OUT} =0A	0.8	2.0
R3132x11Ex					1.078	1.100	1.122			
R3132x12Ex					1.176	1.200	1.224			
R3132x13Ex					1.274	1.300	1.326			
R3132x14Ex					1.372	1.400	1.428			
R3132x15Ex					1.470	1.500	1.530			
R3132x16Ex					1.568	1.600	1.632			
R3132x17Ex					1.666	1.700	1.734			
R3132x18Ex					1.764	1.800	1.836			
R3132x19Ex					1.862	1.900	1.938			
R3132x20Ex					1.960	2.000	2.040			
R3132x21Ex					2.058	2.100	2.142			
R3132x22Ex					2.156	2.200	2.244			
R3132x23Ex					2.254	2.300	2.346			
R3132x24Ex					2.352	2.400	2.448			
R3132x25Ex					2.450	2.500	2.550			
R3132x26Ex					2.548	2.600	2.652			
R3132x27Ex					2.646	2.700	2.754			
R3132x28Ex					2.744	2.800	2.856			
R3132x29Ex					2.842	2.900	2.958			
R3132x30Ex					2.940	3.000	3.060	V _{DD} =V _{DET} -0.1V I _{OUT} =0A	0.9	2.0
R3132x31Ex					3.038	3.100	3.162			
R3132x32Ex					3.136	3.200	3.264			
R3132x33Ex					3.234	3.300	3.366			
R3132x34Ex					3.332	3.400	3.468			
R3132x35Ex					3.430	3.500	3.570			
R3132x36Ex					3.528	3.600	3.672			
R3132x37Ex					3.626	3.700	3.774			
R3132x38Ex					3.724	3.800	3.876			
R3132x39Ex					3.822	3.900	3.978			
R3132x40Ex					3.920	4.000	4.080			
R3132x41Ex					4.018	4.100	4.182			
R3132x42Ex	4.116	4.200	4.284							
R3132x43Ex	4.214	4.300	4.386							
R3132x44Ex	4.312	4.400	4.488							
R3132x45Ex	4.410	4.500	4.590							
R3132x46Ex	4.508	4.600	4.692							
R3132x47Ex	4.606	4.700	4.794							
R3132x48Ex	4.704	4.800	4.896							
R3132x49Ex	4.802	4.900	4.998							
R3132x50Ex	4.900	5.000	5.100							

Supply Current 2			Supply Current 3			“H” Output Voltage	
Iss2[μA]			Iss3[μA]			Voh[V]	
Conditions	Typ.	Max.	Conditions	Typ.	Max.	Conditions	Min.
VDD=VDET+0.1V IOUT=0A	0.8	2.0	VDD=6.0V IOUT=0A	1.2	3.0	VDD=VDET+0.1V IOH=-500uA	0.8× VDD
				1.0	2.5	VDD=VDET+0.1V IOH=-800uA	
VDD=VDET+0.1V IOUT=0A	0.8	2.0	VDD=6.0V IOUT=0A	1.4	3.6	VDD=VDET+0.1V IOH=-50uA	0.8× VDD
						VDD=VDET+0.1V IOH=-150uA	
				1.2	3.0	VDD=VDET+0.1V IOH=-500uA	
						VDD=VDET+0.1V IOH=-800uA	
				1.0	2.5	VDD=VDET+0.1V IOH=-800uA	
						0.8	

R3132x/R3133x

Part Number	“L” Output Voltage		MR pin “H” Input Voltage		MR pin “L” Input Voltage		MR pin pull-up resistance											
	V _{OL} [V]		V _{IH} [V]		V _{IL} [V]		R _{MR} [MΩ]											
	Conditions	Max.	Conditions	Min.	Conditions	Max.	Conditions	Min.	Typ.	Max.								
R3132x23Ex2	V _{DD} =V _{DET} -0.1V I _{OL} =+1.2mA	0.3	V _{DD} ≥ V _{DET} +0.1	0.75× V _{DD}	V _{DD} ≥ V _{DET} +0.1	0.2× V _{DD}	T _{opt} =25°C	0.5	1.0	4.0								
R3132x26Ex3																		
R3132x29Ex3																		
R3132x30Ex8																		
R3132x43Ex8	V _{DD} =V _{DET} -0.1V I _{OL} =+3.2mA	0.4	V _{DD} ≥ V _{DET} +0.1	0.75× V _{DD}	V _{DD} ≥ V _{DET} +0.1	0.2× V _{DD}	T _{opt} =25°C	0.5	1.0	4.0								
R3132x46Ex3																		
R3132x10Ex	V _{DD} =V _{DET} -0.1V I _{OL} =+20μA	0.3									V _{DD} ≥ V _{DET} +0.1	0.75× V _{DD}	V _{DD} ≥ V _{DET} +0.1	0.2× V _{DD}	T _{opt} =25°C	0.5	1.0	4.0
R3132x11Ex																		
R3132x12Ex																		
R3132x13Ex																		
R3132x14Ex			V _{DD} =V _{DET} -0.1V I _{OL} =+750μA	0.3	V _{DD} ≥ V _{DET} +0.1	0.75× V _{DD}	V _{DD} ≥ V _{DET} +0.1	0.2× V _{DD}	T _{opt} =25°C	0.5	1.0	4.0						
R3132x15Ex																		
R3132x16Ex																		
R3132x17Ex																		
R3132x18Ex					V _{DD} =V _{DET} -0.1V I _{OL} =+1.2mA	0.3	V _{DD} ≥ V _{DET} +0.1	0.75× V _{DD}	V _{DD} ≥ V _{DET} +0.1	0.2× V _{DD}	T _{opt} =25°C	0.5	1.0	4.0				
R3132x19Ex																		
R3132x20Ex																		
R3132x21Ex																		
R3132x22Ex							V _{DD} =V _{DET} -0.1V I _{OL} =+3.2mA	0.4	V _{DD} ≥ V _{DET} +0.1	0.75× V _{DD}	V _{DD} ≥ V _{DET} +0.1	0.2× V _{DD}	T _{opt} =25°C	0.5	1.0	4.0		
R3132x23Ex																		
R3132x24Ex																		
R3132x25Ex																		
R3132x26Ex	V _{DD} =V _{DET} -0.1V I _{OL} =+750μA	0.3	V _{DD} ≥ V _{DET} +0.1	0.75× V _{DD}	V _{DD} ≥ V _{DET} +0.1	0.2× V _{DD}			T _{opt} =25°C	0.5	1.0	4.0						
R3132x27Ex																		
R3132x28Ex																		
R3132x29Ex																		
R3132x30Ex			V _{DD} =V _{DET} -0.1V I _{OL} =+1.2mA	0.3	V _{DD} ≥ V _{DET} +0.1	0.75× V _{DD}			V _{DD} ≥ V _{DET} +0.1	0.2× V _{DD}	T _{opt} =25°C	0.5	1.0	4.0				
R3132x31Ex																		
R3132x32Ex																		
R3132x33Ex																		
R3132x34Ex	V _{DD} =V _{DET} -0.1V I _{OL} =+3.2mA	0.4			V _{DD} ≥ V _{DET} +0.1	0.75× V _{DD}	V _{DD} ≥ V _{DET} +0.1	0.2× V _{DD}	T _{opt} =25°C	0.5	1.0	4.0						
R3132x35Ex																		
R3132x36Ex																		
R3132x37Ex																		
R3132x38Ex					V _{DD} =V _{DET} -0.1V I _{OL} =+750μA	0.3	V _{DD} ≥ V _{DET} +0.1	0.75× V _{DD}	V _{DD} ≥ V _{DET} +0.1	0.2× V _{DD}	T _{opt} =25°C	0.5	1.0	4.0				
R3132x39Ex																		
R3132x40Ex																		
R3132x41Ex																		
R3132x42Ex	V _{DD} =V _{DET} -0.1V I _{OL} =+3.2mA	0.4	V _{DD} ≥ V _{DET} +0.1	0.75× V _{DD}	V _{DD} ≥ V _{DET} +0.1	0.2× V _{DD}	T _{opt} =25°C	0.5	1.0	4.0								
R3132x43Ex																		
R3132x44Ex																		
R3132x45Ex																		
R3132x46Ex			V _{DD} =V _{DET} -0.1V I _{OL} =+750μA	0.3	V _{DD} ≥ V _{DET} +0.1	0.75× V _{DD}	V _{DD} ≥ V _{DET} +0.1	0.2× V _{DD}	T _{opt} =25°C	0.5	1.0	4.0						
R3132x47Ex																		
R3132x48Ex																		
R3132x49Ex																		
R3132x50Ex	V _{DD} =V _{DET} -0.1V I _{OL} =+3.2mA	0.4	V _{DD} ≥ V _{DET} +0.1	0.75× V _{DD}	V _{DD} ≥ V _{DET} +0.1	0.2× V _{DD}	T _{opt} =25°C	0.5	1.0	4.0								

Output Delay Time for Release				Detector Threshold Temperature Coefficient	
Tdelay[ms]				$\Delta V_{DET}/\Delta T_{opt}$ [ppm/°C]	
Conditions	Min.	Typ.	Max.	Conditions	
V _{DD} =0.8V→ V _{DET} +1.0V T _{opt} =25°C	204	240	276	-40°C ≤ T _{opt} ≤ 85°C	±100
V _{DD} =0.8V→ V _{DET} +1.0V T _{opt} =25°C	204	240	276	-40°C ≤ T _{opt} ≤ 85°C	±100

R3132x/R3133x

● R3133x

Part Number	Operating Voltage				Detector Threshold			Supply Current 1		
	V _{DD} [V]				-V _{DET} [V]			I _{SS1} [μA]		
	Conditions	Max.	Conditions	Max.	Min.	Typ.	Max.	Conditions	Typ.	Max.
R3133x23Ex2	T _{opt} =25°C	0.80	-40°C ≤ T _{opt} ≤ 85°C	0.90	2.274	2.320	2.366	V _{DD} =V _{DET} -0.1V I _{OUT} =0A	0.8	2.0
R3133x26Ex3					2.578	2.630	2.682			
R3133x29Ex3					2.872	2.930	2.988			
R3133x30Ex8					3.019	3.080	3.141			
R3133x43Ex8					4.293	4.380	4.467			
R3133x46Ex3					4.538	4.630	4.722			
R3133x10Ex	T _{opt} =25°C	0.80	-40°C ≤ T _{opt} ≤ 85°C	0.90	0.980	1.000	1.020	V _{DD} =V _{DET} -0.1V I _{OUT} =0A	0.8	2.0
R3133x11Ex					1.078	1.100	1.122			
R3133x12Ex					1.176	1.200	1.224			
R3133x13Ex					1.274	1.300	1.326			
R3133x14Ex					1.372	1.400	1.428			
R3133x15Ex					1.470	1.500	1.530			
R3133x16Ex					1.568	1.600	1.632			
R3133x17Ex					1.666	1.700	1.734			
R3133x18Ex					1.764	1.800	1.836			
R3133x19Ex					1.862	1.900	1.938			
R3133x20Ex					1.960	2.000	2.040			
R3133x21Ex					2.058	2.100	2.142			
R3133x22Ex					2.156	2.200	2.244			
R3133x23Ex					2.254	2.300	2.346			
R3133x24Ex					2.352	2.400	2.448			
R3133x25Ex					2.450	2.500	2.550			
R3133x26Ex					2.548	2.600	2.652			
R3133x27Ex					2.646	2.700	2.754			
R3133x28Ex					2.744	2.800	2.856			
R3133x29Ex					2.842	2.900	2.958			
R3133x30Ex					2.940	3.000	3.060		0.9	
R3133x31Ex					3.038	3.100	3.162			
R3133x32Ex					3.136	3.200	3.264			
R3133x33Ex					3.234	3.300	3.366			
R3133x34Ex					3.332	3.400	3.468			
R3133x35Ex					3.430	3.500	3.570			
R3133x36Ex					3.528	3.600	3.672			
R3133x37Ex					3.626	3.700	3.774			
R3133x38Ex					3.724	3.800	3.876			
R3133x39Ex					3.822	3.900	3.978			
R3133x40Ex					3.920	4.000	4.080			
R3133x41Ex					4.018	4.100	4.182			
R3133x42Ex	4.116	4.200	4.284							
R3133x43Ex	4.214	4.300	4.386							
R3133x44Ex	4.312	4.400	4.488							
R3133x45Ex	4.410	4.500	4.590							
R3133x46Ex	4.508	4.600	4.692							
R3133x47Ex	4.606	4.700	4.794							
R3133x48Ex	4.704	4.800	4.896							
R3133x49Ex	4.802	4.900	4.998							
R3133x50Ex	4.900	5.000	5.100							

Supply Current 2			Supply Current 3			“H” Output Voltage	
Iss2[μ A]			Iss3[μ A]			VoH[V]	
Conditions	Typ.	Max.	Conditions	Typ.	Max.	Conditions	Min.
VDD=VDET+0.1V IOUT=0A	0.8	2.0	VDD=6.0V IOUT=0A	1.2	3.0	VDD=VDET-0.1V IOH=-500uA	0.8× VDD
				1.0	2.5	VDD=VDET-0.1V IOH=-800uA	
VDD=VDET+0.1V IOUT=0A	0.8	2.0	VDD=6.0V IOUT=0A	1.4	3.6	VDD=VDET-0.1V IOH=-10uA	0.8× VDD
						VDD=VDET-0.1V IOH=-100uA	
				1.2	3.0	VDD=VDET-0.1V IOH=-500uA	
						VDD=VDET-0.1V IOH=-800uA	
				1.0	2.5	VDD=VDET-0.1V IOH=-800uA	
						0.8	

R3132x/R3133x

Part Number	“L” Output Voltage		MR pin “H” Input Voltage		MR pin “L” Input Voltage		MR pin pull-up resistance			
	V _{OL} [V]		V _{IH} [V]		V _{IL} [V]		R _{MR} [MΩ]			
	Conditions	Max.	Conditions	Max.	Conditions	Min.	Conditions	Min.	Typ.	Max.
R3133x23Ex2	V _{DD} =V _{DET} +0.1V I _{OL} =+1.2mA	0.3	V _{DD} ≥ V _{DET} +0.1	0.75× V _{DD}	V _{DD} ≥ V _{DET} +0.1	0.2× V _{DD}	T _{opt} =25°C	0.5	1.0	2.0
R3133x26Ex3										
R3133x29Ex3										
R3133x30Ex8										
R3133x43Ex8	V _{DD} =V _{DET} +0.1V I _{OL} =+3.2mA	0.4	V _{DD} ≥ V _{DET} +0.1	0.75× V _{DD}	V _{DD} ≥ V _{DET} +0.1	0.2× V _{DD}	T _{opt} =25°C	0.5	1.0	2.0
R3133x46Ex3										
R3133x10Ex	V _{DD} =V _{DET} +0.1V I _{OL} =+20μA	0.3	V _{DD} ≥ V _{DET} +0.1	0.75× V _{DD}	V _{DD} ≥ V _{DET} +0.1	0.2× V _{DD}	T _{opt} =25°C	0.5	1.0	2.0
R3133x11Ex										
R3133x12Ex	V _{DD} =V _{DET} +0.1V I _{OL} =+750μA	0.3	V _{DD} ≥ V _{DET} +0.1	0.75× V _{DD}	V _{DD} ≥ V _{DET} +0.1	0.2× V _{DD}	T _{opt} =25°C	0.5	1.0	2.0
R3133x13Ex										
R3133x14Ex										
R3133x15Ex										
R3133x16Ex										
R3133x17Ex										
R3133x18Ex										
R3133x19Ex										
R3133x20Ex										
R3133x21Ex										
R3133x22Ex	V _{DD} =V _{DET} +0.1V I _{OL} =+1.2mA	0.3	V _{DD} ≥ V _{DET} +0.1	0.75× V _{DD}	V _{DD} ≥ V _{DET} +0.1	0.2× V _{DD}	T _{opt} =25°C	0.5	1.0	2.0
R3133x23Ex										
R3133x24Ex										
R3133x25Ex										
R3133x26Ex										
R3133x27Ex										
R3133x28Ex										
R3133x29Ex										
R3133x30Ex										
R3133x31Ex										
R3133x32Ex										
R3133x33Ex										
R3133x34Ex										
R3133x35Ex										
R3133x36Ex										
R3133x37Ex										
R3133x38Ex										
R3133x39Ex										
R3133x40Ex										
R3133x41Ex										
R3133x42Ex										
R3133x43Ex										
R3133x44Ex										
R3133x45Ex										
R3133x46Ex										
R3133x47Ex										
R3133x48Ex										
R3133x49Ex										
R3133x50Ex										

Output Delay Time for Release				Detector Threshold Temperature Coefficient	
Tdelay[ms]				$\Delta V_{DET}/\Delta T_{opt}$ [ppm/°C]	
Conditions	Min.	Typ.	Max.	Conditions	Typ.
V _{DD} =0.8V→ V _{DET} +1.0V T _{opt} =25°C	204	240	276	-40°C ≤ T _{opt} ≤ 85°C	±100
V _{DD} =0.8V→ V _{DET} +1.0V T _{opt} =25°C	204	240	276	-40°C ≤ T _{opt} ≤ 85°C	±100

OPERATION

- Operation of R3132x Series

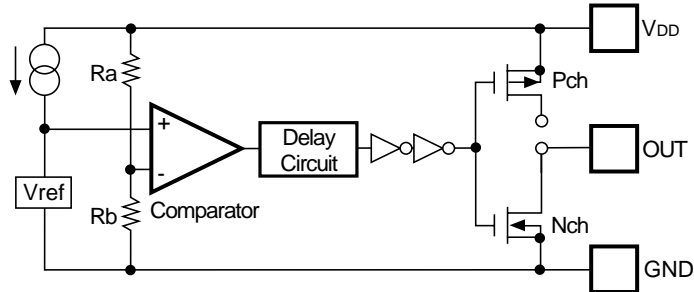

Block Diagram

- CMOS Output Type
OUT pin is connected to the drain of Nch Tr. and Pch Tr. in this IC.
- Nch Open Drain Output Type
OUT pin is connected to the drain of Nch Tr. in this IC.
(OUT pin should be pulled up to V_{DD} or an external voltage level.)

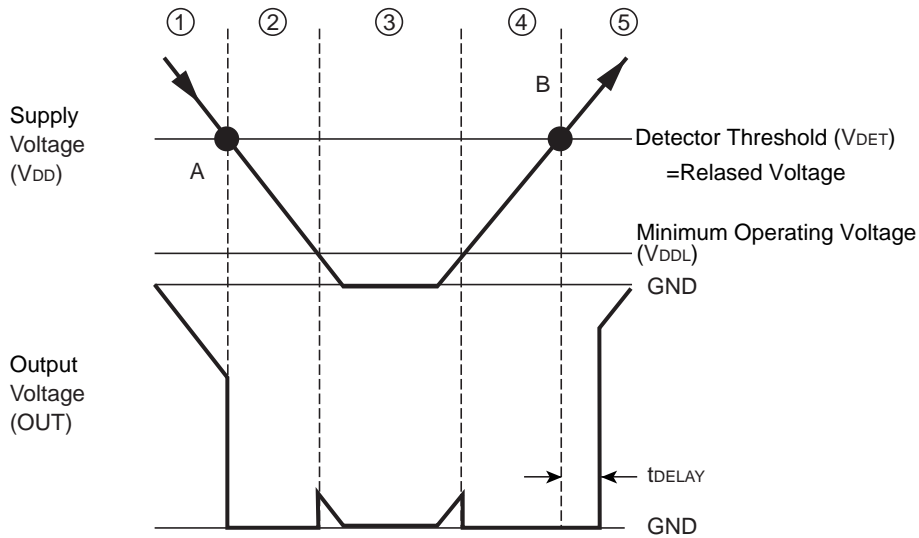

Operating Diagram

In the above diagram,

- ① Output voltage becomes equal to supply voltage (Nch open drain output type; equal to pull-up Voltage).
 - ② When the supply voltage is down to the detector threshold level (Point A), $V_{ref} \geq V_{DD} \times R_b / (R_a + R_b)$ is true. Then, the output of the comparator is reversed, thus output voltage becomes equal to GND level.
 - ③ When the supply voltage is lower than minimum operating voltage, the output of transistor is indefinite, therefore the output is also indefinite.
 - ④ Output voltage is equal to GND level.
 - ⑤ When the supply voltage is higher than the released voltage (Point B), $V_{ref} \geq V_{DD} \times R_b / (R_a + R_b)$ is true. Then the output of the comparator is reversed, thus the output voltage becomes equal to the supply voltage (Nch open drain output type; equal to pull-up voltage).
- * There is no hysteresis range between the detector threshold and the released voltage.

• Operation of R3133x Series

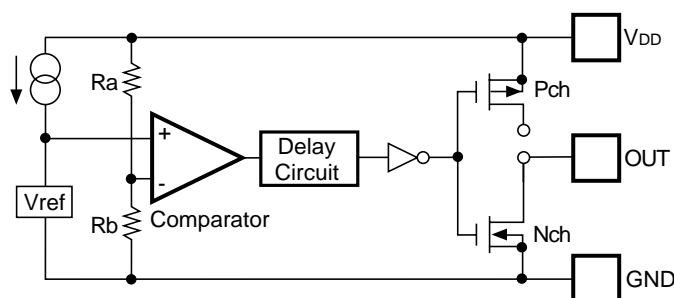

Block Diagram

- CMOS Output Type:
Out pin is connected to the drain of Nch Tr. and Pch Tr. in this IC.
- Nch Open Drain Output Type: I
Out pin is connected to the drain of Nch Tr. in this IC.
(OUT pin should be pulled up to V_{DD} or an external voltage level.)

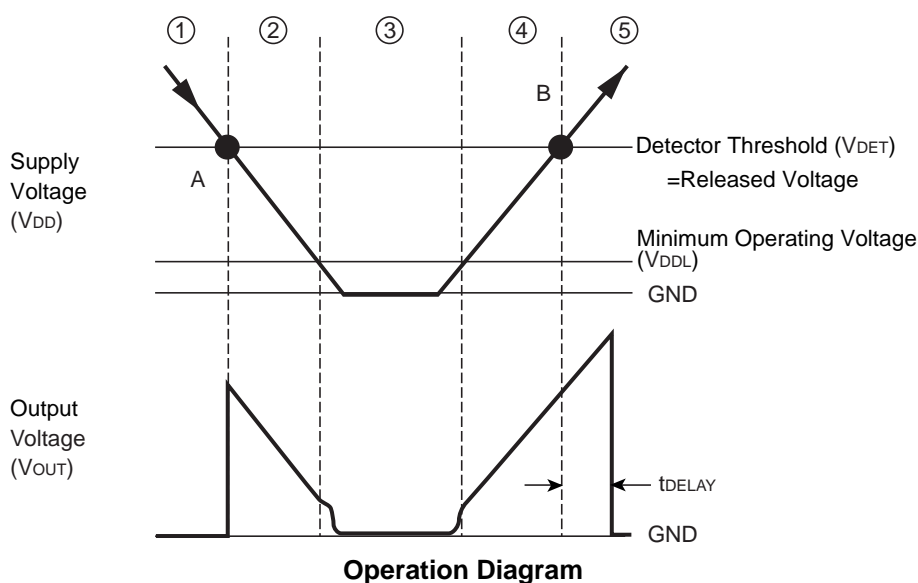

Operation Diagram

In the above diagram,

- ① Output voltage becomes equal to GND level.
- ② When the supply voltage is down to the detector threshold level (Point A), $V_{ref} \geq V_{DD} \times R_b / (R_a + R_b)$ is true. Then, the output of the comparator is reversed, thus output voltage becomes equal to the supply voltage (Nch open drain output type; equal to pull-up voltage).
- ③ When the supply voltage is lower than minimum operating voltage, the output of transistor is indefinite, therefore the output is also indefinite. (Nch open drain output type; the output voltage level is equal to pull-up voltage.)
- ④ Output voltage is equal to the supply voltage. (Nch open drain output type; equal to pull-up Voltage.)
- ⑤ When the supply voltage is higher than the released voltage (Point B), $V_{ref} \leq V_{DD} \times R_b / (R_a + R_b)$ is true. Then the output of the comparator is reversed, thus the output voltage becomes equal to GND level after the output delay time.

* There is no hysteresis range between the detector threshold and the released voltage.

TECHNICAL NOTES

When the IC is released, if a large pulse (glitch) which crosses the detector threshold voltage is in, the IC may not maintain the released condition. The amplitude of the pulse ($V_{DET}-V_{DDmin}$) and the pulse width the IC can maintain the released level is described in the graph as follows:

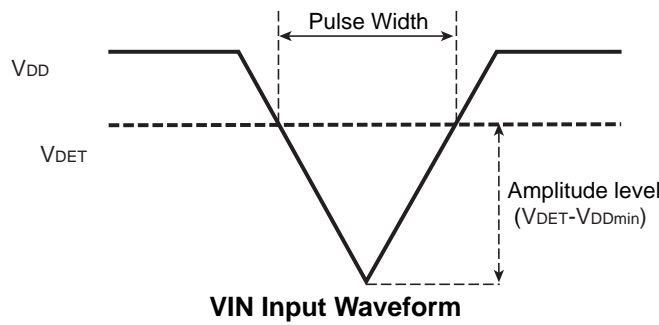
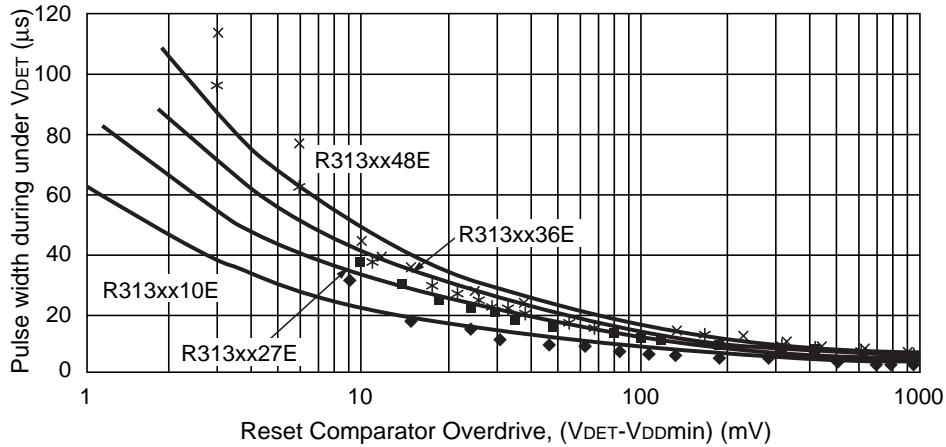

Notes:

The graph above shows the condition for the maximum transient duration without generating a reset. If the larger amplitude or larger pulse width noise than the graph may be on the V_{DD} , the reset signal may be generated.

Application Notes

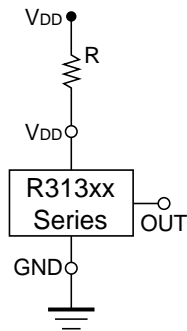

Figure A

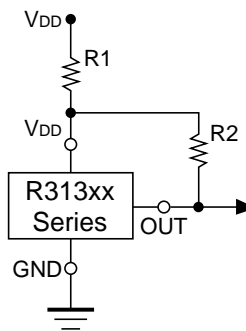
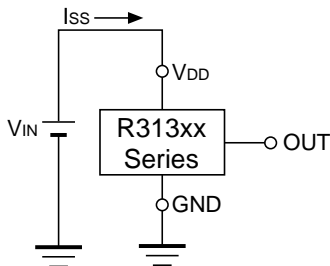

Figure B

The connection such as Figure A and Figure B may cause the loop oscillation because of the cross conduction current. Not only that, these types connection may make shift the detector threshold level because of the voltage dropout with consumption current of the IC itself.

TEST CIRCUITS



Test Circuit for Supply Current

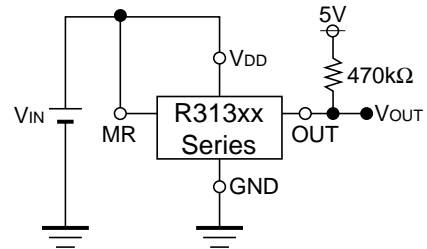

Test Circuit for Detector Threshold
(CMOS Output type; pull-up part is not necessary.)

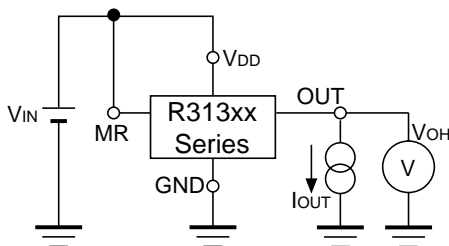

Test Circuit for "H" Output Voltage
(CMOS Output Type only)

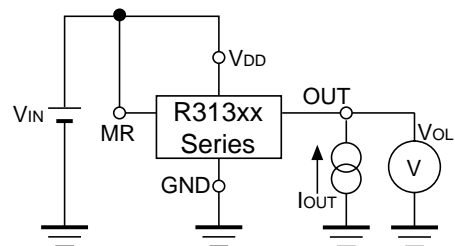

Test Circuit for "L" Output Voltage

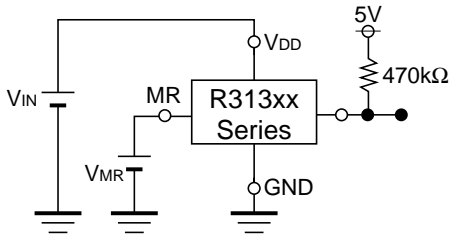

Test Circuit for MR pin Input Voltage
(CMOS Output type; pull-up part is not necessary.)

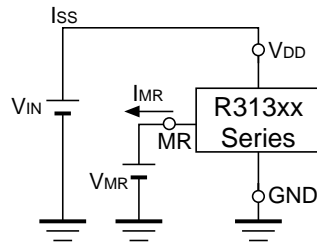

Test Circuit for MR pin Pull-up Resistance

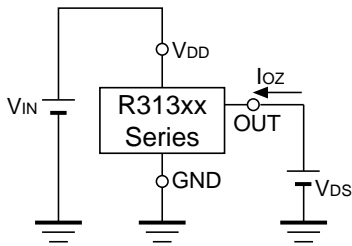

Test Circuit for Off Leakage Current

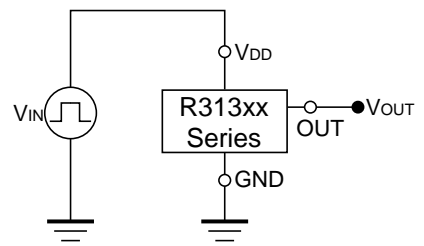
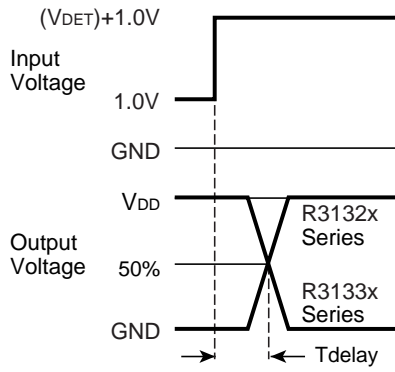

Test Circuit for Output Delay Time
(CMOS Output type; pull-up is not necessary.)

TYPICAL CHARACTERISTICS

1) Supply Current vs. Input Voltage

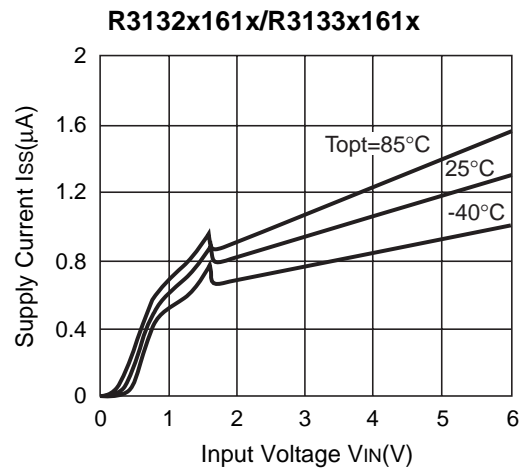
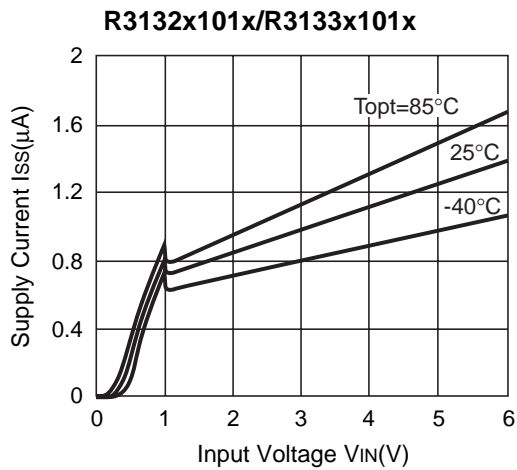

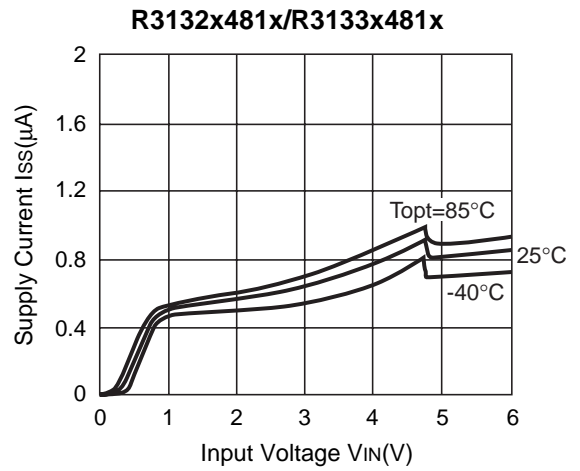
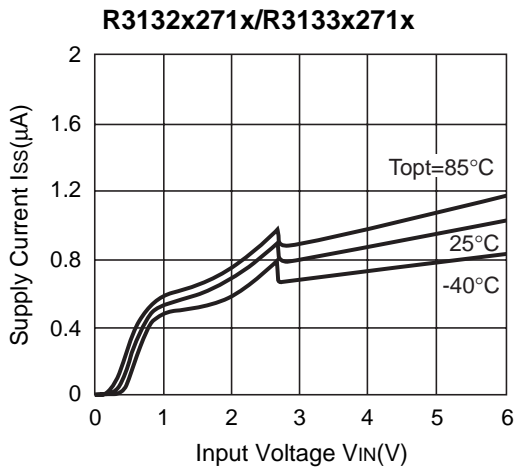

2) Detector Threshold vs. Temperature

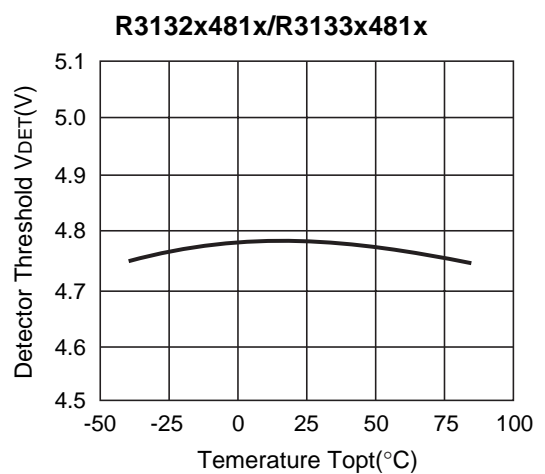
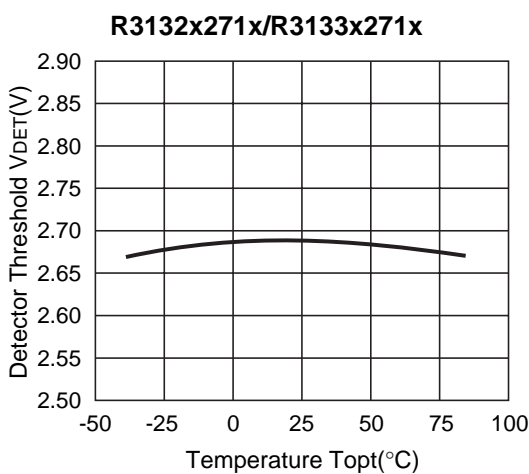
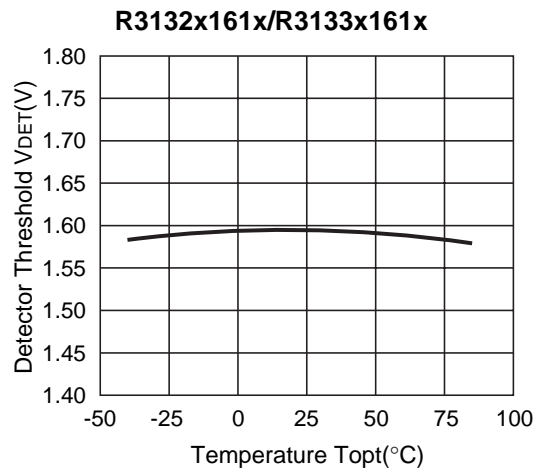
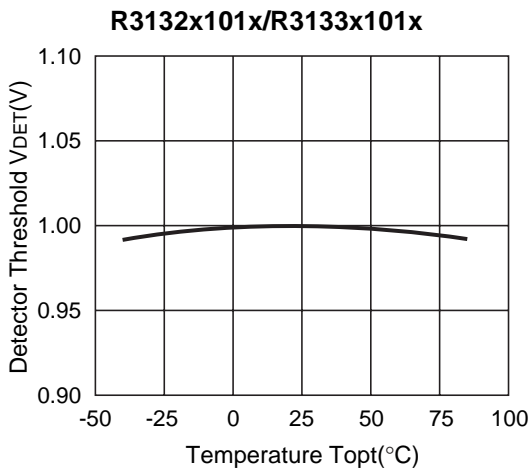

3) Nch Driver Output Current vs. V_{DS} ($T_{opt}=25^{\circ}C$)

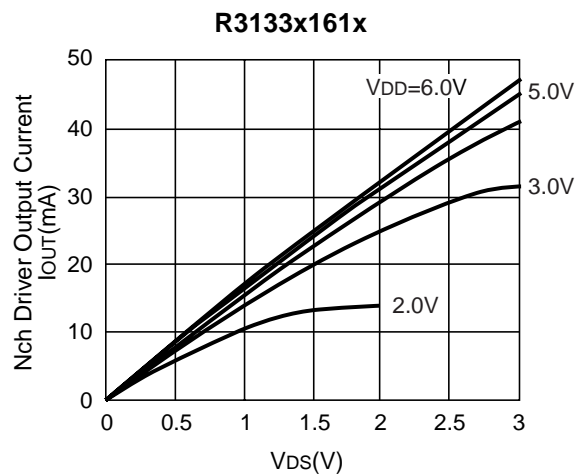
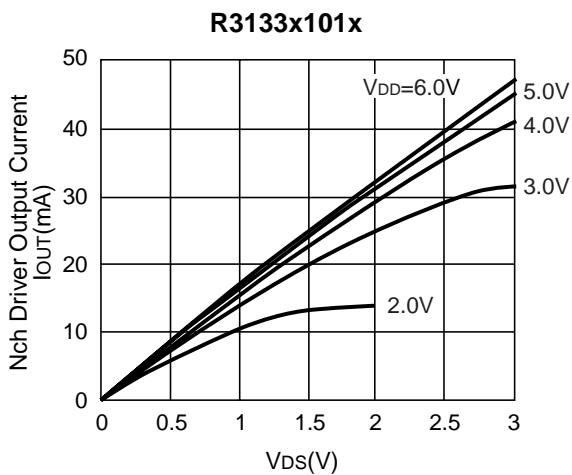
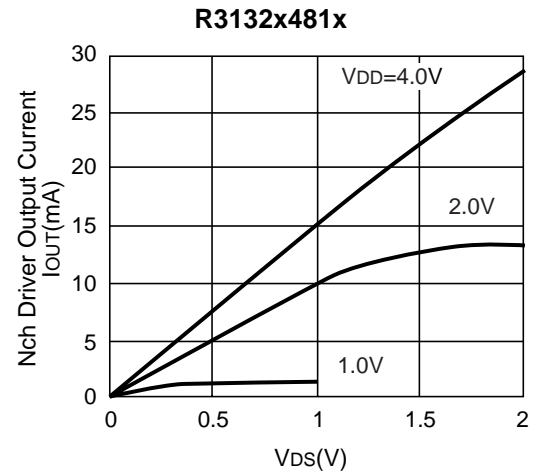
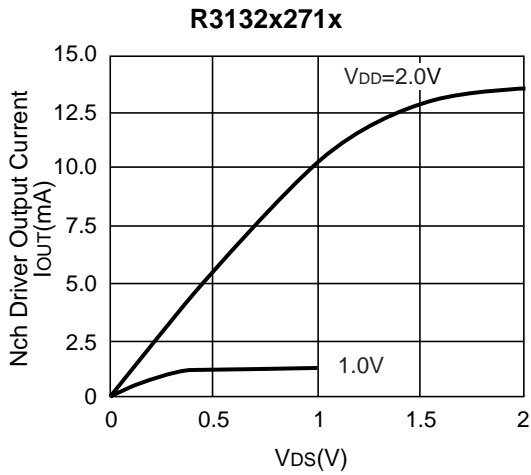
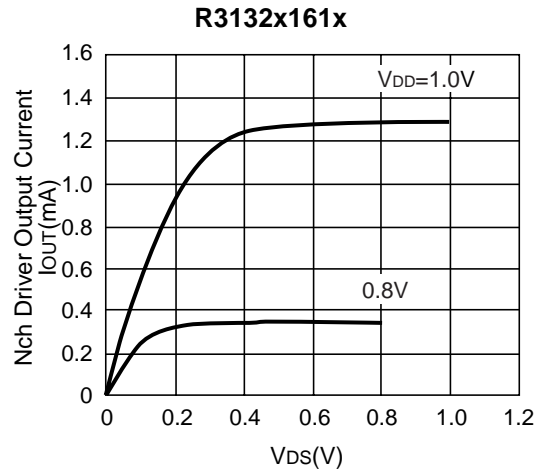
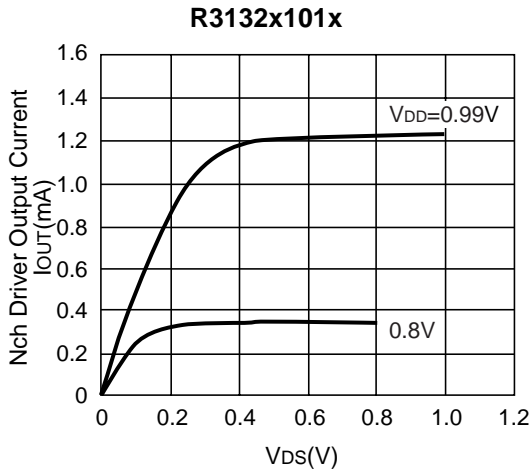

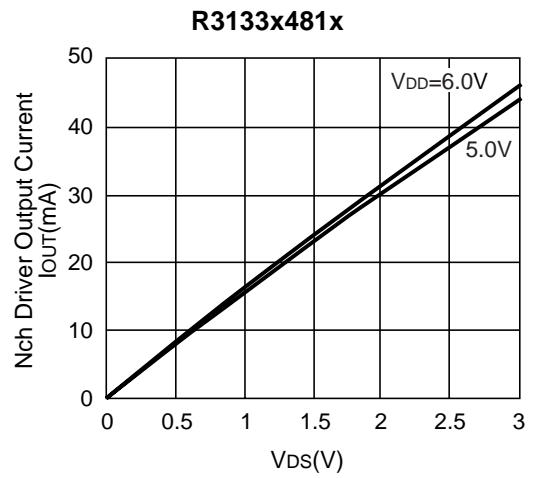
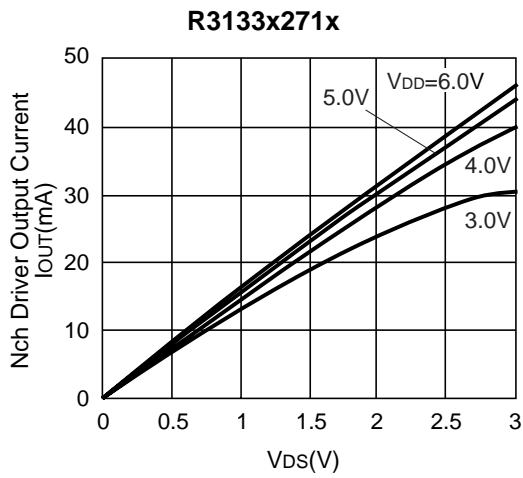

4) Nch Driver Output Current vs. Input Voltage ($V_{DS}=0.5V$)

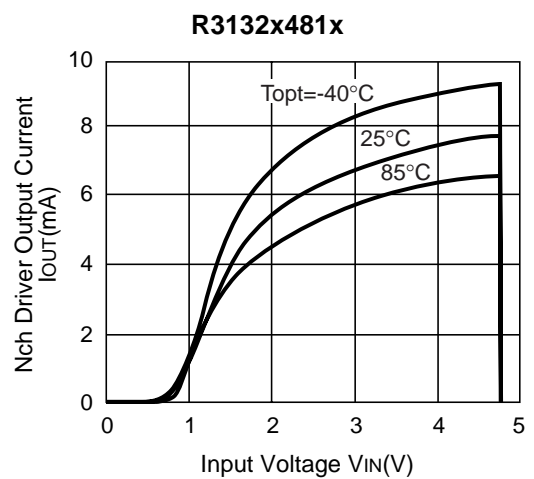
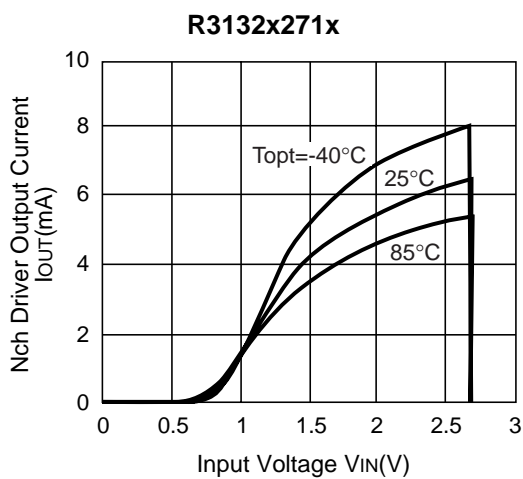
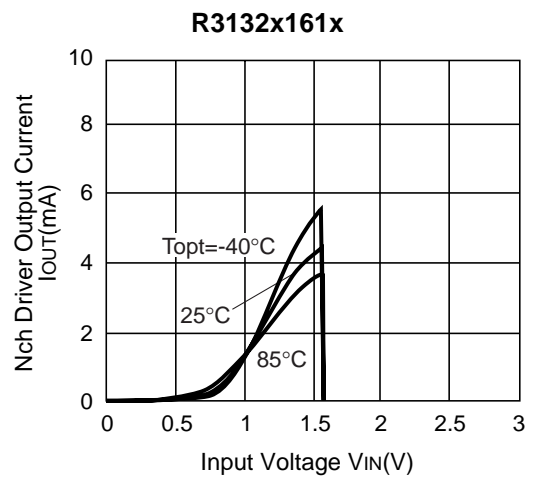
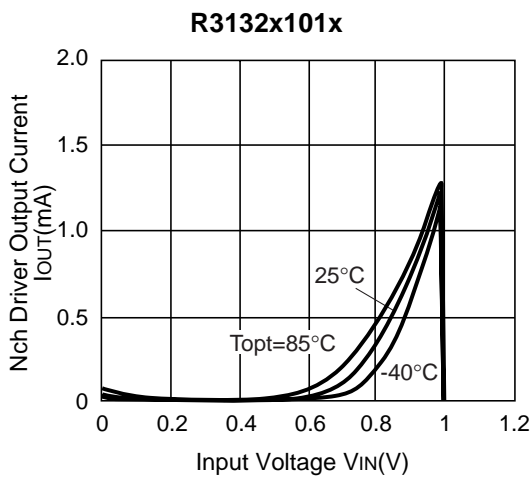

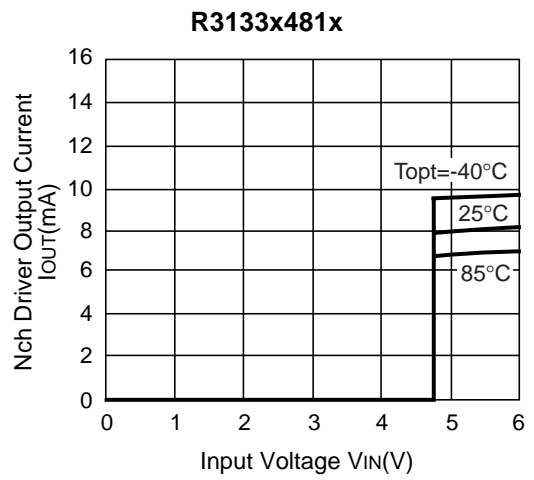
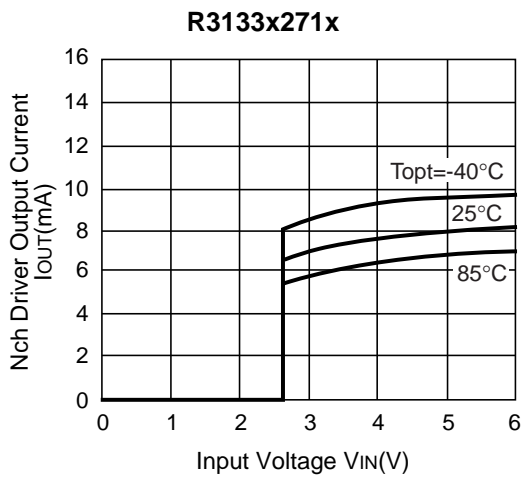
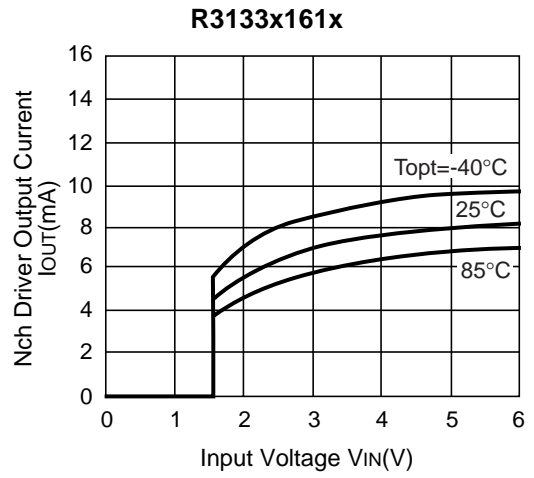
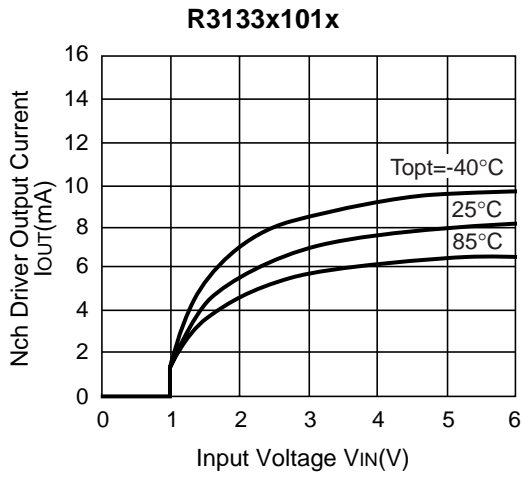

5) Pch Driver Output Current vs. Input Voltage

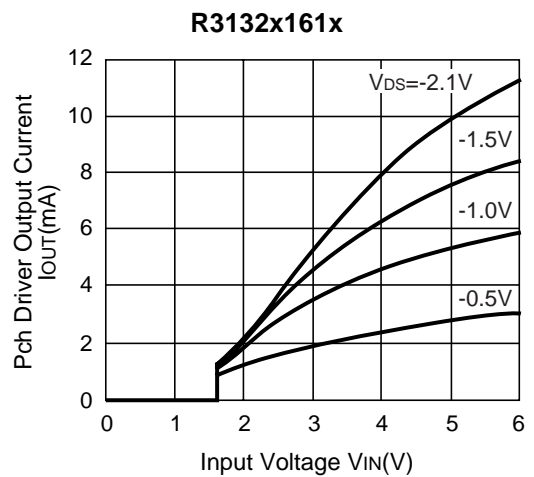
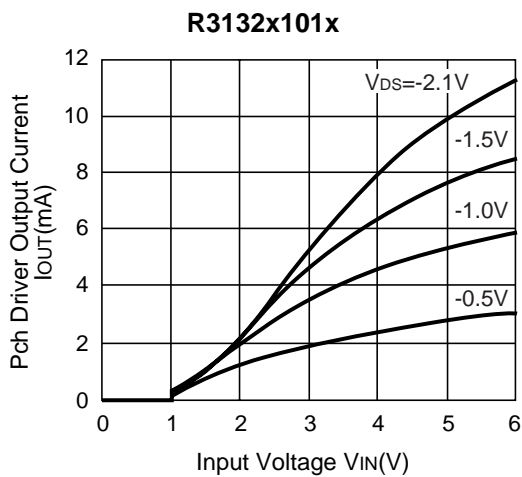

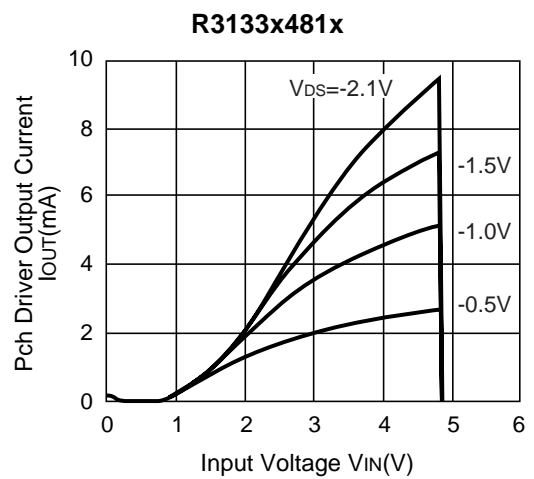
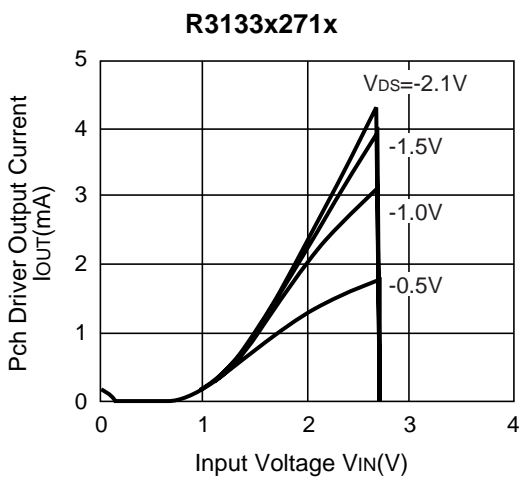
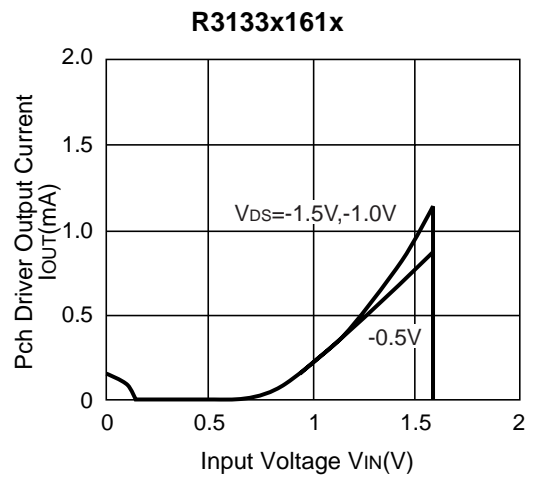
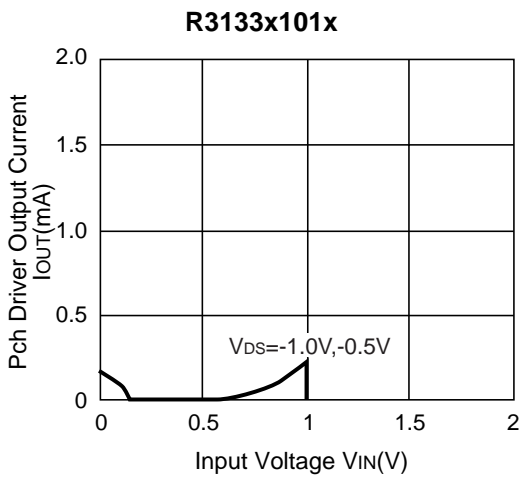
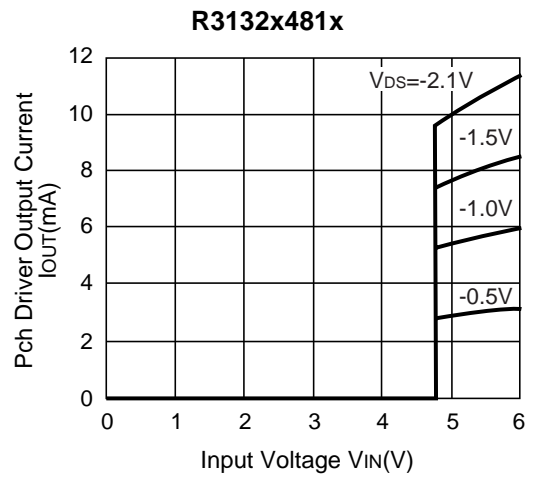
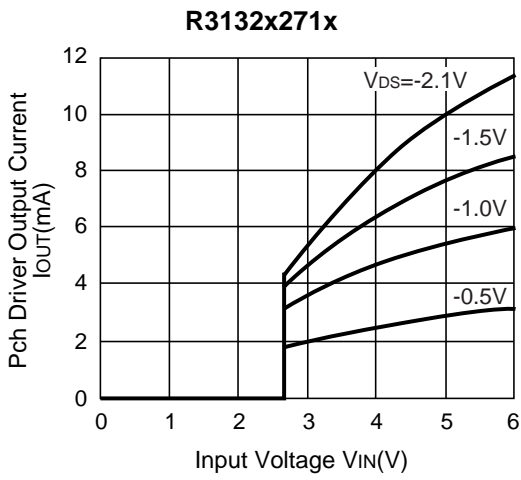

6) Output Delay Time at Detection Mode vs. Temperature

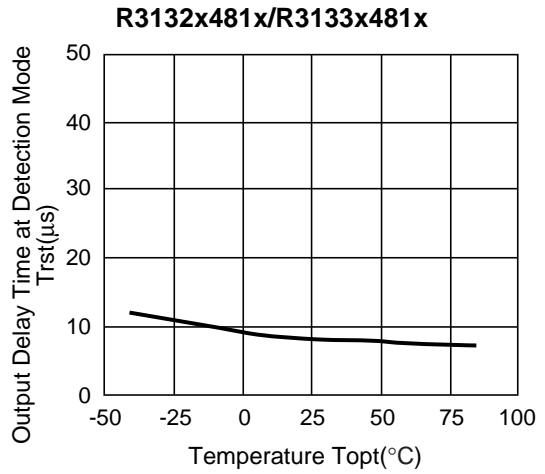
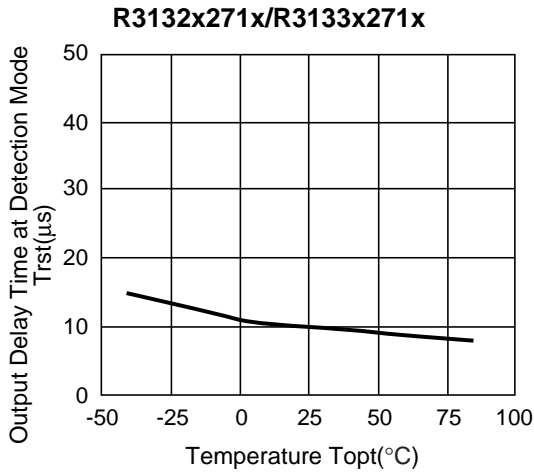
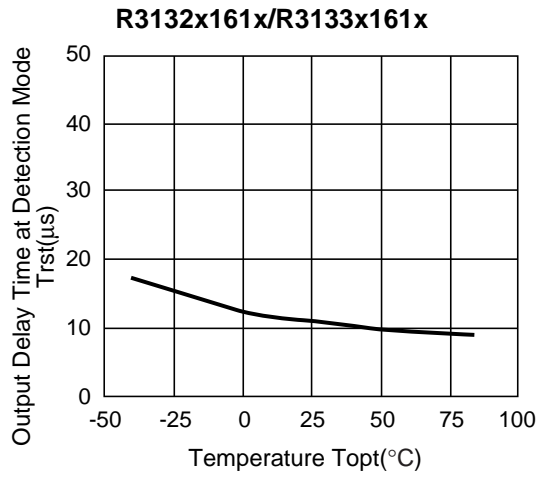
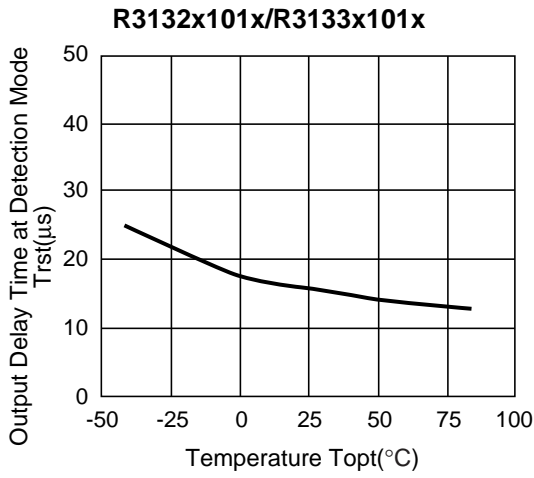

7) Power-on Reset Delay Time vs. Temperature

