

2000 Slide Switches - Snap-in & 2 hole fixing 10A 250Vac



- ▶ 2 way 'voltage selector'
- ▶ Ratings up to 10A, 250V ac
- ▶ Snap in and flange mounting
- ▶ PCB & solder terminals
- ▶ 2 and 3 position
- ▶ Choice of circuits
- ▶ Choice of actuators



10 A 250Vac T85
6(3)A 250Vac T85



UL CSA 16A 250Vac Non Inductive
UL CSA 4A 300Vac
UL65°C, file no. E45221, CSA file no. LR10990



RoHS compliant

μ contact gap

Please specify: Standard action (SP116) or light action (SP118).
2000 series lubrication is inorganic and does not degrade plastics.

Technical data on pages 4 & 5.

115/230 is preferred legend

B BLACK
W WHITE
R RED

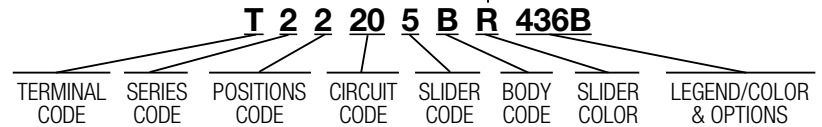

ORDER FORMAT

| ▶ TERMINAL | ▶ SERIES | ▶ POS'N | ▶ CIRCUIT <small>Viewed from back</small> | ▶ SLIDER | | | | | | | | | | | | | |
|---|----------|--------------------------|--|----------|---|---|---|---|--|--|--|--|--|--|--|--|--|
| <p>K</p> <p>2.8 x 0.8</p> | | 2 Switching positions | 10 | 0 | 6 | C | L | S | | | | | | | | | |
| | | | 20 | 2 | 7 | D | M | T | | | | | | | | | |
| | | | 30 | 3 | 8 | E | N | | | | | | | | | | |
| | | | 40 | 4 | 9 | H | P | | | | | | | | | | |
| <p>R</p> <p>2.8 x 0.8</p> | | | 10 | 5 | A | K | R | | | | | | | | | | |
| | | | 20 | 6 | | | | | | | | | | | | | |
| | | | 30 | 7 | | | | | | | | | | | | | |
| | | | 40 | 8 | | | | | | | | | | | | | |
| <p>T</p> <p>Solder</p> | | 3 Switching positions | 10 | 9 | | | | | | | | | | | | | |
| | | | 20 | | | | | | | | | | | | | | |
| | | | 30 | | | | | | | | | | | | | | |
| | | | 40 | | | | | | | | | | | | | | |
| <p>X</p> <p>PCB 0.8 Sq. For mounting stability switches have extra "support" terminals</p> <p>* Nominal - Dimension varies with body type. For exact figure call factory</p> | | | 10 | | | | | | | | | | | | | | |
| | | | 20 | | | | | | | | | | | | | | |
| | | | 30 | | | | | | | | | | | | | | |
| | | | 40 | | | | | | | | | | | | | | |



T22208E



T22308E



T2230MF



T22205B



T22305B



T23204B

BODY

B With fixing holes

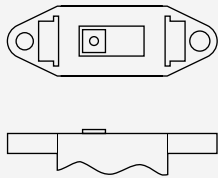

E Snap-in

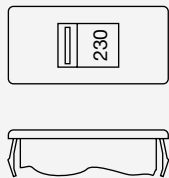

Cut-outs must be punched in the direction of insertion

F Snap-in (single pole ON OFF only)

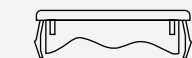
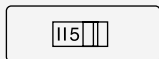

Cut-outs must be punched in the direction of insertion

OPTIONS

Color

For custom slider colors call the factory. A full range is available for large orders

Standard body color is black

Legend printing

2 Frequently requested legends are shown

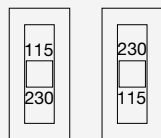

436() 437()

() is legend color
(B) - Black
(W) - White
(R) - Red

Please call the factory for custom legends

DIMENSIONS (mm)

2 Pos B

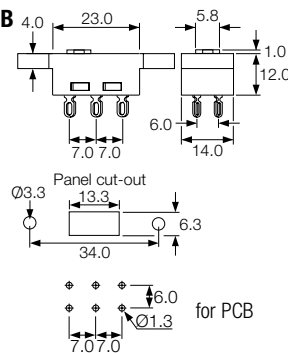

Cut-out / PCB Matrix

3 Pos B

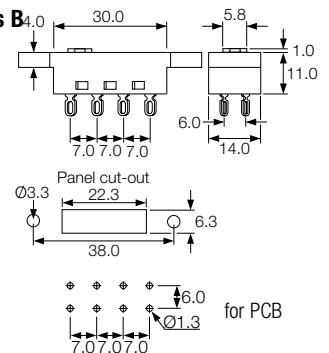

2 Pos E

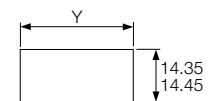
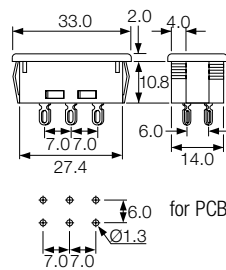

| Panel thickness | Dim. Y |
|-----------------|-------------|
| 0.8-1.2 | 29.75/29.85 |
| 1.63 | 30.15/30.25 |
| 2.0 | 30.35/30.45 |
| 2.5 | 30.55/30.65 |

2 Pos F

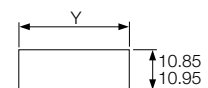
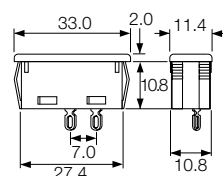

| Panel thickness | Dim. Y |
|-----------------|-------------|
| 0.8-1.2 | 29.75/29.85 |
| 1.63 | 30.15/30.25 |
| 2.0 | 30.35/30.45 |
| 2.5 | 30.55/30.65 |

for PCB, call factory for details