



SAW multimedia filters

Series/Type: M3565D

The following products presented in this data sheet are being withdrawn.

Ordering Code	Substitute Product	Date of Withdrawal	Deadline Last Orders	Last Shipments
B39458M3565N301		2011-01-14	2011-09-30	2012-09-30

For further information please contact your nearest EPCOS sales office, which will also support you in selecting a suitable substitute. The addresses of our worldwide sales network are presented at www.epcos.com/sales.



SAW Components

M 3565 D

IF Filter for Quasi/Split Sound Applications

45,75 MHz

Data Sheet

Standard

Duroplast package **SIP5D**

- M/N

Features

- TV IF filter for quasi/split sound applications (separate picture and sound channel)
- Picture channel with Nyquist slope and sound suppression, symmetrical output
- High color carrier
- Constant group delay
- Sound channel with pass band for sound carrier only
- Standard IC package

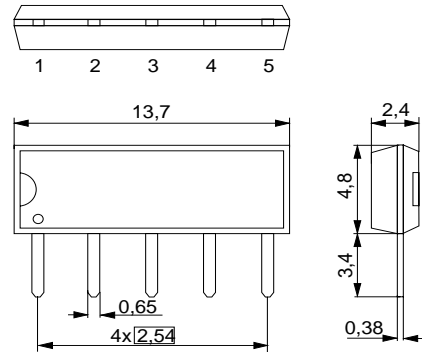

Terminals

- Tinned CuFe alloy

Dimensions in mm, approx. weight 0,5 g

Pin configuration

- 1 Input
- 2 Chip carrier - ground
- 3 Output - sound
- 4 Output - picture
- 5 Output - picture

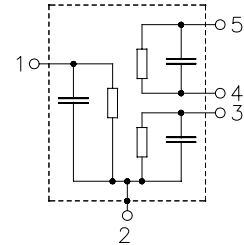

Type	Ordering code	Marking and package according to	Packing according to
M 3565 D	B39458-M3565-N301	C61157-A1-A21	F61074-V8049-Z000

Maximum ratings

Operating temperature range	T_A	- 25/+ 65	°C	
Storage temperature range	T_{stg}	- 40/+ 85	°C	
DC voltage	V_{DC}	5	V	between any terminals
AC voltage	V_{pp}	10	V	between any terminals



SAW Components

M 3565 D

IF Filter for Quasi/Split Sound Applications

45,75 MHz

Data Sheet

Characteristics of picture channel

Reference temperature: $T_A = 25 (45) \text{ }^\circ\text{C}$
 Terminating source impedance: $Z_S = 50 \text{ } \Omega$
 Terminating load impedance: $Z_L = 2 \text{ k}\Omega \parallel 3 \text{ pF}$

		min.	typ.	max.	
Insertion attenuation	α				
Reference level for the following data	44,06 (44,00) MHz	13,5	15,0	16,5	dB
Relative attenuation	α_{rel}				
Picture carrier	45,81 (45,75) MHz	6,0	7,0	8,0	dB
Color carrier	42,23 (42,17) MHz	-1,8	-0,8	0,2	dB
	42,06 (42,00) MHz	—	-0,5	—	dB
Sound carrier	41,31 (41,25) MHz	17,0	22,0	—	dB
Adjacent picture carrier	39,81 (39,75) MHz	45,0	52,0	—	dB
Adjacent sound carrier	47,31 (47,25) MHz	38,0	47,0	—	dB
Lower sidelobe	35,06 ... 39,81 (35,00 ... 39,75) MHz	40,0	45,0	—	dB
Upper sidelobe	47,31 ... 55,06 (47,25 ... 55,00) MHz	35,0	40,0	—	dB
Reflected wave signal suppression					
1,2 μs ... 6,0 μs after main pulse (test pulse 250 ns, carrier frequency 44,06 MHz)		42,0	52,0	—	dB
Feedthrough signal suppression					
1,3 μs ... 1,2 μs before main pulse (test pulse 250 ns, carrier frequency 44,06 MHz)		50,0	56,0	—	dB
Group delay ripple (p-p)	$\Delta\tau$	—	50	—	ns
Impedance at 44,06 MHz					
Input: $Z_{IN} = R_{IN} \parallel C_{IN}$		—	1,0 \parallel 19,4	—	k Ω \parallel pF
Output: $Z_{OUT} = R_{OUT} \parallel C_{OUT}$		—	1,7 \parallel 3,9	—	k Ω \parallel pF
Temperature coefficient of frequency	TC_f	—	-72	—	ppm/K



SAW Components

M 3565 D

IF Filter for Quasi/Split Sound Applications

45,75 MHz

Data Sheet

Characteristics of sound channel

Reference temperature: $T_A = 25 (45) \text{ }^\circ\text{C}$
 Terminating source impedance: $Z_S = 50 \text{ } \Omega$
 Terminating load impedance: $Z_L = 2 \text{ k}\Omega \parallel 3 \text{ pF}$

		min.	typ.	max.	
Insertion attenuation	α				
Reference level for the following data	41,31 (41,25) MHz	10,6	12,1	13,6	dB
Relative attenuation	α_{rel}				
Picture carrier	45,81 (45,75) MHz	38,0	46,0	—	dB
Color carrier	42,23 (42,17) MHz	18,0	24,0	—	dB
Adjacent picture carrier	39,81 (39,75) MHz	40,0	50,0	—	dB
Adjacent sound carrier	47,31 (47,25) MHz	40,0	47,0	—	dB
Lower sidelobe					
	35,06 ... 39,81 (35,00 ... 39,75) MHz	37,0	42,0	—	dB
Upper sidelobe					
	47,31 ... 55,06 (47,25 ... 55,00) MHz	37,0	43,0	—	dB
Impedance at 41,31 MHz					
Input: $Z_{IN} = R_{IN} \parallel C_{IN}$		—	0,6 21,7	—	k Ω pF
Output: $Z_{OUT} = R_{OUT} \parallel C_{OUT}$		—	1,4 4,0	—	k Ω pF
Temperature coefficient of frequency	TC_f	—	-72	—	ppm/K



SAW Components

M 3565 D

IF Filter for Quasi/Split Sound Applications

45,75 MHz

Data Sheet

Frequency response of picture channel

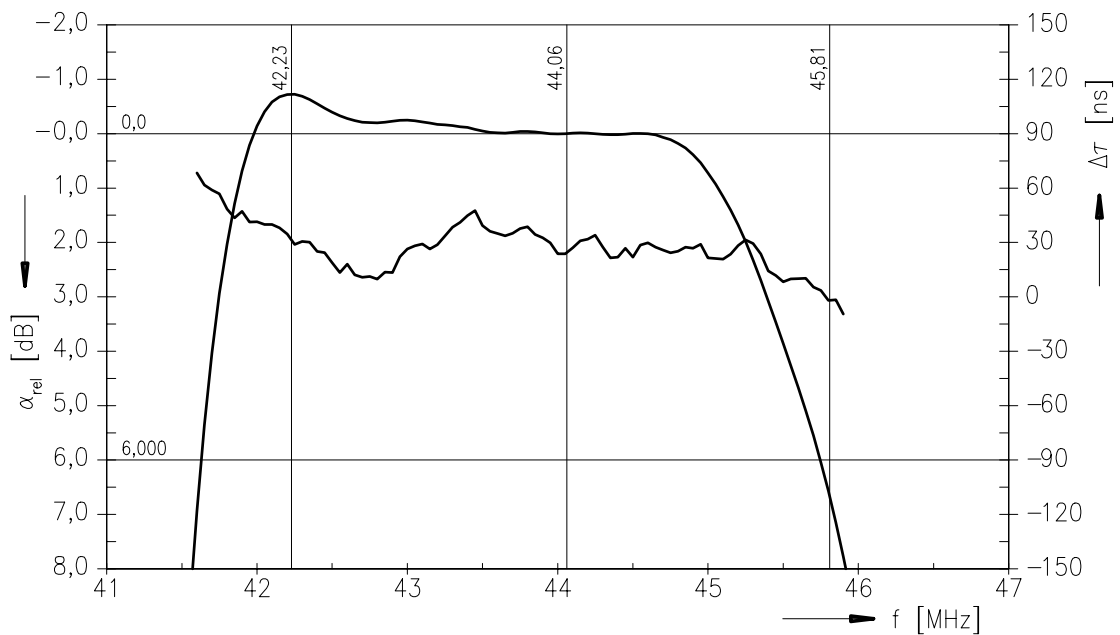
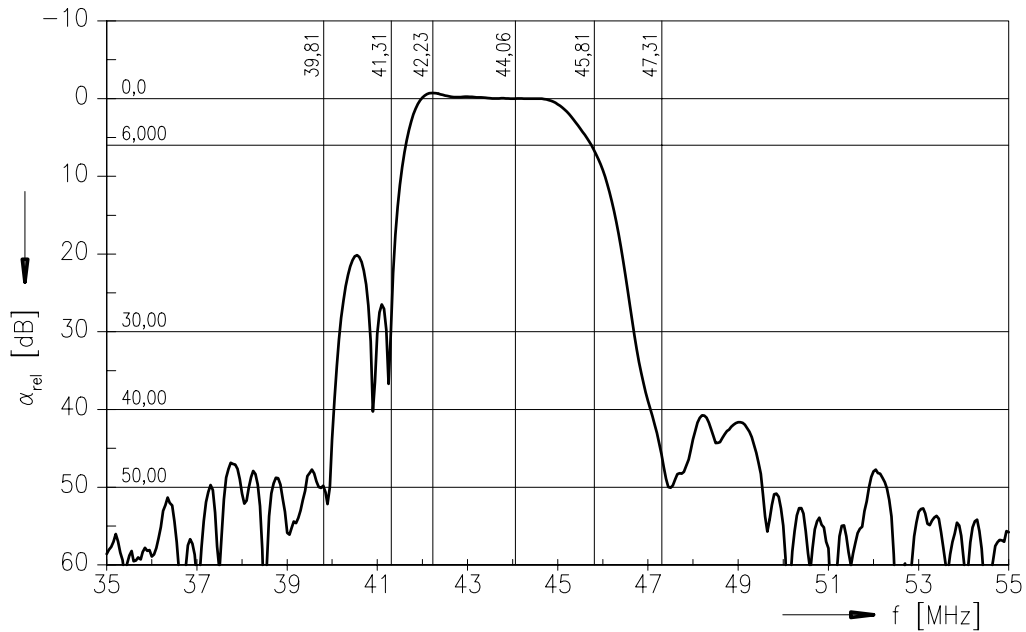



SAW Components

M 3565 D

IF Filter for Quasi/Split Sound Applications

45,75 MHz

Data Sheet

Frequency response of picture channel

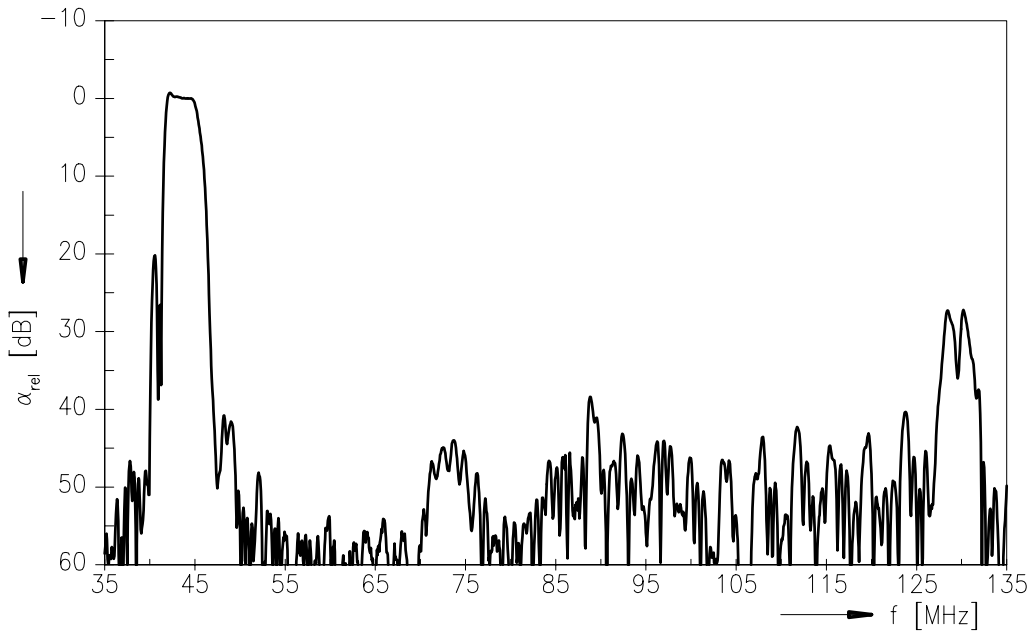

Time domain response of picture channel

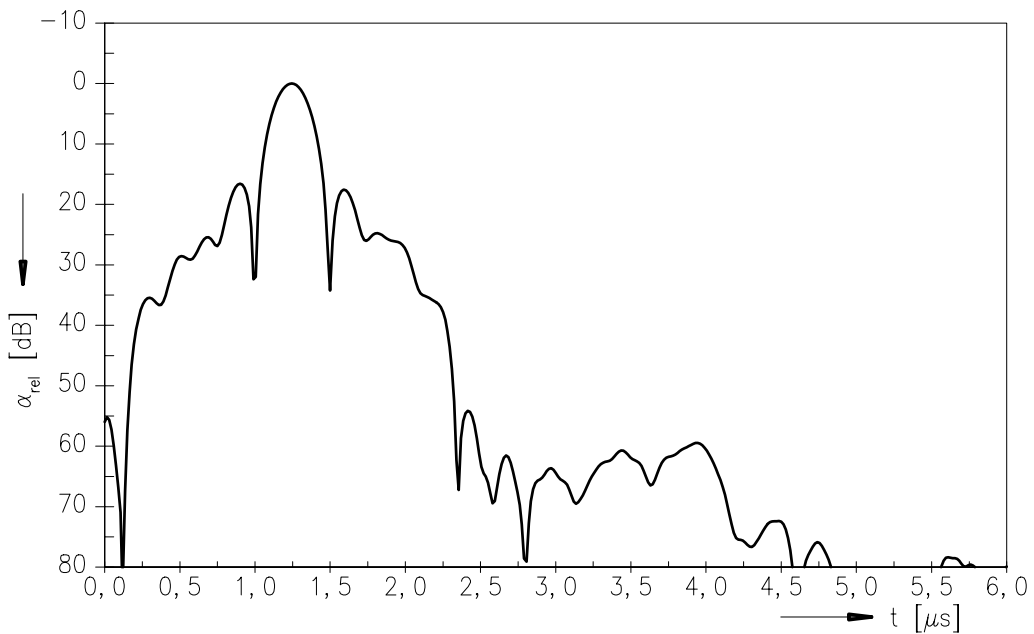



SAW Components

M 3565 D

IF Filter for Quasi/Split Sound Applications

45,75 MHz

Data Sheet

Frequency response of sound channel

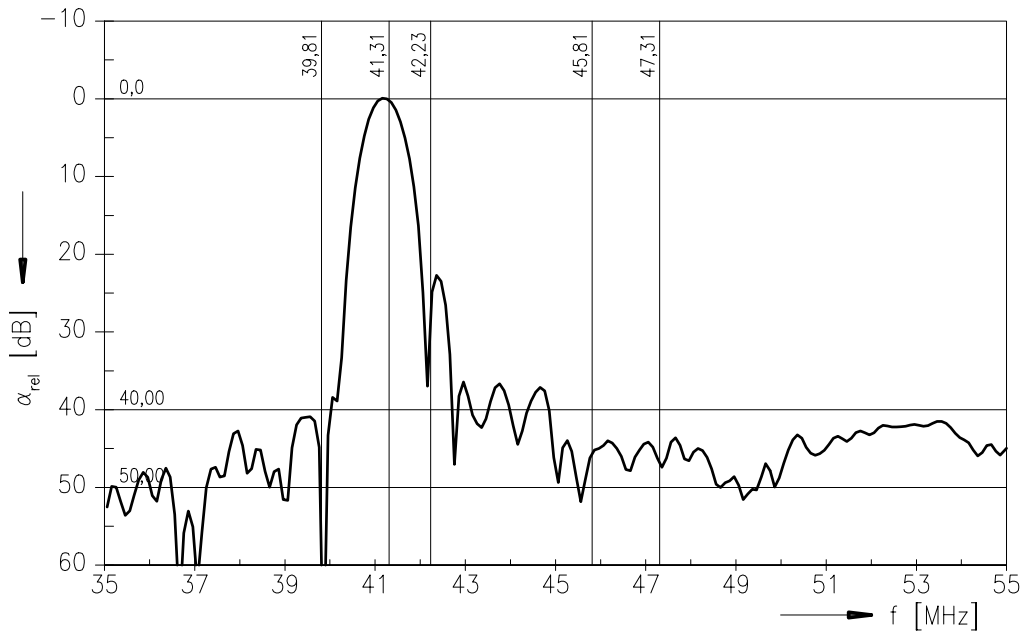



SAW Components

M 3565 D

IF Filter for Quasi/Split Sound Applications

45,75 MHz

Data Sheet

Published by EPCOS AG

Surface Acoustic Wave Components Division, SAW CE MM PD

P.O. Box 80 17 09, 81617 Munich, GERMANY

© EPCOS AG 2003. Reproduction, publication and dissemination of this brochure and the information contained therein without EPCOS' prior express consent is prohibited.

Purchase orders are subject to the General Conditions for the Supply of Products and Services of the Electrical and Electronics Industry recommended by the ZVEI (German Electrical and Electronic Manufacturers' Association), unless otherwise agreed.

This brochure replaces the previous edition.

For questions on technology, prices and delivery please contact the Sales Offices of EPCOS AG or the international Representatives.

Due to technical requirements components may contain dangerous substances. For information on the type in question please also contact one of our Sales Offices.