

LEAD FREE  
VERSIONS ARE  
ROHS COMPLIANT

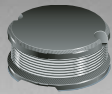

**BOURNS®**

## Features

- Available in E12 series
- Low profile of only 2.5 mm
- Low inductance values
- Lead free version available (see How to Order)
- Lead free versions are RoHS compliant\*

## Applications

- Input/output of DC/DC converters
- Power supplies for:
  - Portable communication equipment
  - Camcorders
  - LCD TVs
  - Car radios

# SDR0302 Series - SMD Power Inductors

### Electrical Specifications

Bourns Part No.	Inductance 1kHz		Q Ref.	Test Frequency (MHz)	SRF Min. (MHz)	RDC Max. (Ω)	I rms Max. (A)	I sat Typ. (A)
	(μH)	Tol. %						
SDR0302-1R0M_	1.0	± 20	20	7.96	125.0	0.06	2.100	2.700
SDR0302-1R2M_	1.2	± 20	22	7.96	100.0	0.07	2.000	2.500
SDR0302-1R5M_	1.5	± 20	23	7.96	95.0	0.07	1.900	2.300
SDR0302-1R8M_	1.8	± 20	23	7.96	85.0	0.08	1.800	2.000
SDR0302-2R2M_	2.2	± 20	22	7.96	75.0	0.09	1.650	1.850
SDR0302-2R7M_	2.7	± 20	22	7.96	72.0	0.10	1.500	1.700
SDR0302-3R3M_	3.3	± 20	23	7.96	68.0	0.11	1.400	1.600
SDR0302-3R9M_	3.9	± 20	24	7.96	50.0	0.12	1.300	1.500
SDR0302-4R7M_	4.7	± 20	18	7.96	45.0	0.15	1.200	1.350
SDR0302-5R6M_	5.6	± 20	18	7.96	42.0	0.16	1.100	1.300
SDR0302-6R8M_	6.8	± 20	18	7.96	40.0	0.18	1.000	1.200
SDR0302-8R2M_	8.2	± 20	16	7.96	35.0	0.20	0.900	1.050
SDR0302-100M_	10.0	± 20	18	2.52	34.0	0.25	0.800	0.900
SDR0302-120M_	12.0	± 20	15	2.52	33.0	0.28	0.750	0.850
SDR0302-150M_	15.0	± 20	20	2.52	32.0	0.40	0.650	0.800
SDR0302-180M_	18.0	± 20	18	2.52	28.0	0.46	0.580	0.750
SDR0302-220M_	22.0	± 20	23	2.52	22.0	0.66	0.520	0.650
SDR0302-270M_	27.0	± 20	23	2.52	20.0	0.75	0.480	0.550
SDR0302-330K_	33.0	± 10	20	2.52	18.0	0.85	0.420	0.500
SDR0302-390K_	39.0	± 10	24	2.52	18.0	1.12	0.380	0.450
SDR0302-470K_	47.0	± 10	23	2.52	17.0	1.27	0.360	0.400
SDR0302-560K_	56.0	± 10	18	2.52	16.0	1.45	0.340	0.350
SDR0302-680K_	68.0	± 10	24	2.52	14.0	1.85	0.300	0.320
SDR0302-820K_	82.0	± 10	24	2.52	12.0	2.10	0.280	0.300
SDR0302-101K_	100.0	± 10	40	0.796	10.0	2.85	0.260	0.280
SDR0302-121K_	120.0	± 10	40	0.796	10.0	3.20	0.220	0.250
SDR0302-151K_	150.0	± 10	38	0.796	9.0	4.60	0.200	0.230
SDR0302-181K_	180.0	± 10	45	0.796	8.5	5.00	0.185	0.210
SDR0302-221K_	220.0	± 10	40	0.796	8.0	5.70	0.170	0.190
SDR0302-271K_	270.0	± 10	45	0.796	7.0	8.60	0.150	0.170
SDR0302-331K_	330.0	± 10	40	0.796	6.0	10.00	0.130	0.150
SDR0302-391K_	390.0	± 10	40	0.796	5.5	10.80	0.120	0.140
SDR0302-471K_	470.0	± 10	42	0.796	5.0	14.30	0.105	0.130
SDR0302-561K_	560.0	± 10	43	0.796	4.8	16.00	0.095	0.120
SDR0302-681K_	680.0	± 10	43	0.796	4.3	18.00	0.085	0.110
SDR0302-821K_	820.0	± 10	45	0.796	4.0	22.50	0.080	0.100
SDR0302-102K_	1000.0	± 10	40	0.252	3.2	26.00	0.070	0.090
SDR0302-122K_	1200.0	± 10	40	0.252	3.0	30.00	0.060	0.080

### General Specifications

Test Voltage .....1 V  
 Reflow Soldering ....230 °C, 50 sec. max.  
 Operating Temperature ..-40 °C to +125 °C  
 (Temperature rise included)  
 Storage Temperature ..-40 °C to +125 °C  
 Resistance to Soldering Heat  
 .....260 °C for 5 sec.

### Materials

Core .....Ferrite DR  
 Wire .....Enamelled copper wire 130  
 Terminal Electrode .....See How to Order  
 Rated Current  
 .....Ind. drop 10 % typ. at Isat  
 Temperature Rise .....40 °C max.  
 at rated Irms  
 Packaging .....1000 pcs. per reel

### Product Dimensions

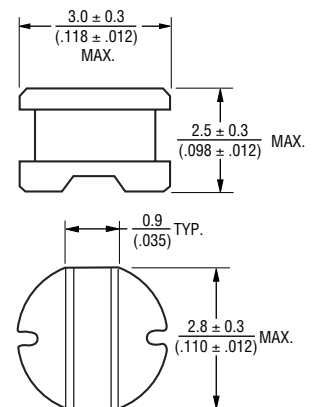

### Recommended Layout

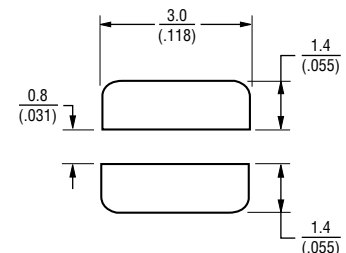

### Typical Part Marking

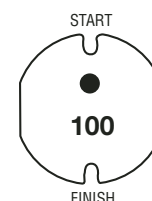

### How to Order

**SDR0302 - 100M**

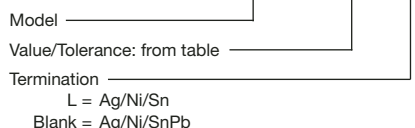

### Electrical Schematic

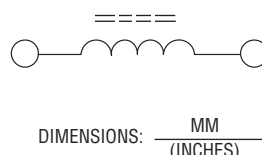

\*RoHS Directive 2002/95/EC Jan 27 2003 including Annex Specifications are subject to change without notice. Customers should verify actual device performance in their specific applications.

# SDR0302 Series - SMD Power Inductors

**BOURNS®**

## Packaging Specifications

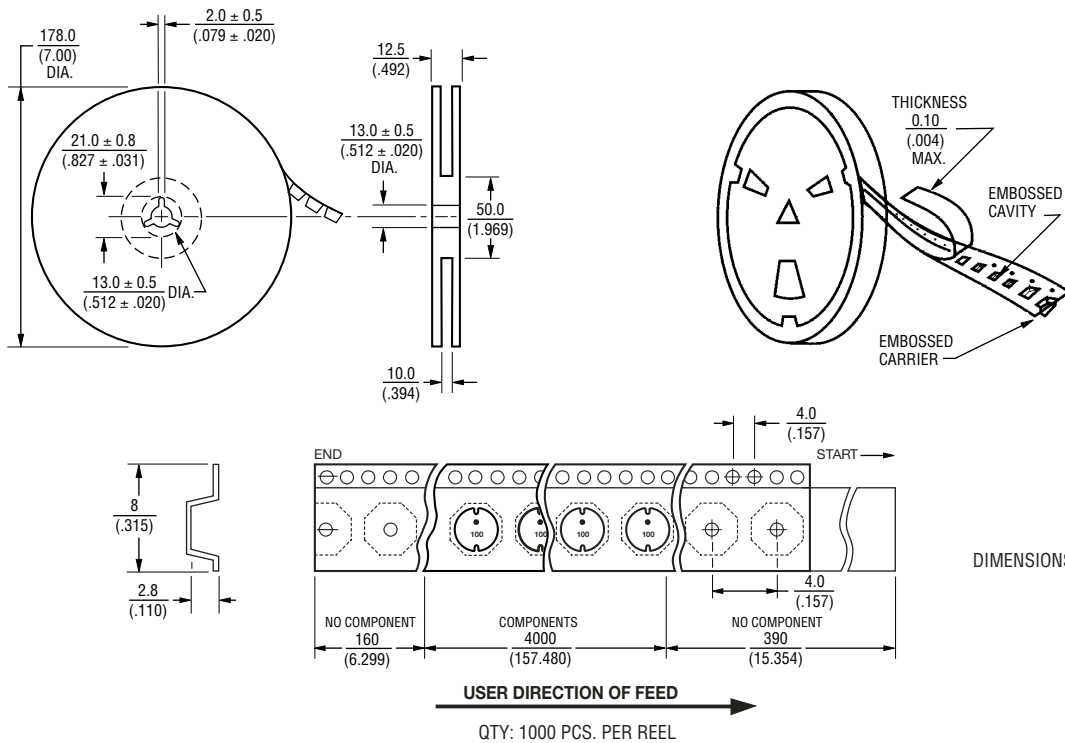

DIMENSIONS:  $\frac{\text{MM}}{\text{(INCHES)}}$