

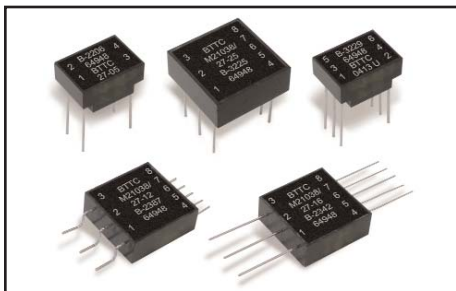

BETA TRANSFORMER TECHNOLOGY CORPORATION

A Subsidiary of Data Device Corporation
40 Orville Drive, Bohemia, NY 11716-2529
Phone: (631) 244-7393; Fax: (631) 244-8893
Web site: www.bttc-beta.com

B-2200/2300/3200 SERIES



MIL-STD-1553 TRANSFORMERS FULLY QUALIFIED TO DESC SPECIFICATION MIL-PRF-21038/27

FEATURES

- **Fully Qualified to DESC Specification No. 21038/27**
- **For use with MIL-STD-1553A and B, MacAir A-5690, A-5232, and A-4905**
- **Low-Profile**
- **-55°C to +130°C Operating Temperature Range**
- **Built and Tested to MIL-PRF-21038 and MIL-STD-202**
- **Listed On QPL-21038-31**
- **Qualification Validated Annually**

DESCRIPTION AND APPLICATIONS

The military data bus specification, MIL-STD-1553, has brought about the need for versatile pulse transformers that meet all the electrical requirements of Manchester II serial bi-phase data transmission. The B-2200/2300/3200 series of transformers provide the turns ratio configurations, component isolation, and common mode rejection ratio characteristics necessary for MIL-STD-1553A and B compliance.

The step-up and step-down ratios that are available with the B-2200/2300/3200 series complement DDC's entire MIL-STD-1553 product line. These transformers are low-profile, modular units that are multi-tapped to accommodate existing system configurations. Encapsulated in accordance with MIL-PRF-21038, their SN63 solder-dipped copper-clad steel leads conveniently accommodate printed circuit board mounting. Sinusoidal or trapezoidal waveforms are accurately processed, making the B-2200/2300/3200 series of transformers an excellent choice for any MIL-STD-1553A or B application.

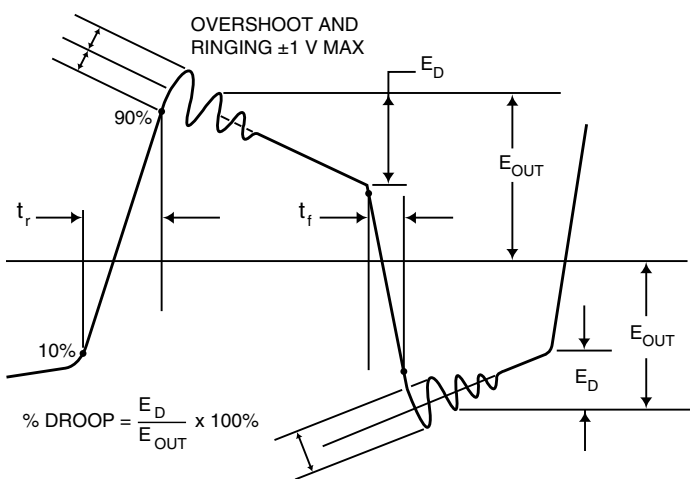

FIGURE 1. WAVEFORM INTEGRITY

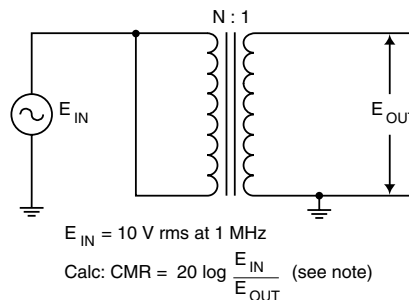
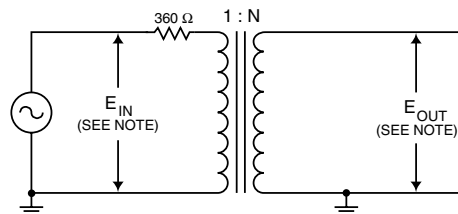

FIGURE 2. CIRCUIT FOR COMMON MODE REJECTION



E_{IN} = 250 kHz square wave, 27.0 volts peak-to-peak with a rise and fall time no greater than 100 ns.

Calc : Droop = $\frac{E_D}{E_{OUT}} \times 100\%$. (see figure 1 for E_D)

FIGURE 3. CIRCUIT FOR WAVEFORM INTEGRITY

Note: Input to be applied and output to be measured for all dash numbers are as shown. N represents highest turns winding in each test.

TABLE 1. B-2200/2300/3200 SERIES SPECIFICATIONS

PARAMETER	UNIT	VALUE	REMARK
Case			Flame Resistant, DIALLYL PHTHALATE
Terminals			SN63 Solder-Dipped Copper-Clad Steel
Weight	oz (gm)	0.175 (5) max	
Terminal Strength	lbs	2	2 pounds applied force, Method 211, MIL-STD-202, Test condition A
Dielectric Withstanding Voltage	Vrms	100	Method 301, MIL-STD-202
Life (expectancy "X")	Hrs	10,000 min	In accordance with MIL-PRF-21038
Insulation Resistance	M Ohm	1,000 min	At 250 Vdc using method 302, test condition B, MIL-STD-202
Pulse Width (of Output Pulse)	µs	2	Tested using FIGURE 3 with resulting FIGURE 1 waveform.
Overshoot	V	<1	Tested using FIGURE 3 with resulting FIGURE 1 waveform.
Rise Time (of Output Pulse)	ns		Tested using FIGURE 3 with resulting FIGURE 1 waveform.
Common Mode Rejection	db	45 min	See Respective ELECTRICAL CHARACTERISTICS TABLE
Operating Temperature Range	°C	-55 to +130	Tested using FIGURE 2.
Droop	%	20 max	Tested using FIGURE 3 with resulting FIGURE 1 waveform.
DC Resistance	Ohm		See respective ELECTRICAL CHARACTERISTICS TABLE
Input Impedance	Ohm		See respective ELECTRICAL CHARACTERISTICS TABLE

CONFIGURATION A

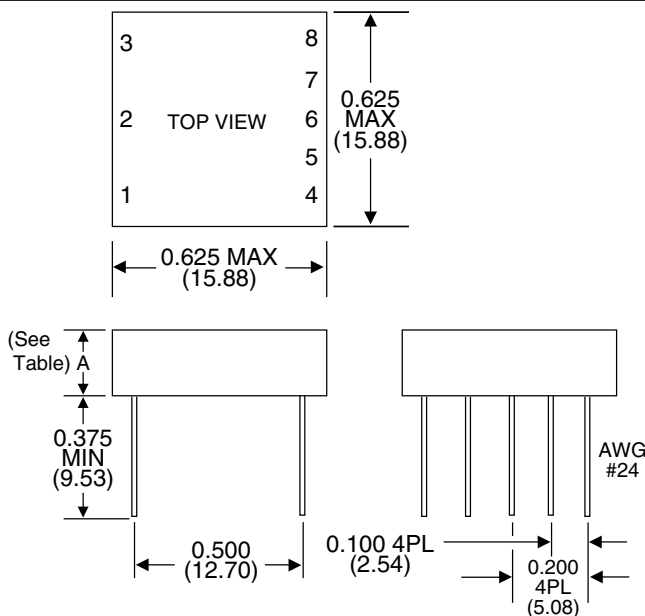
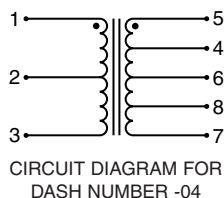
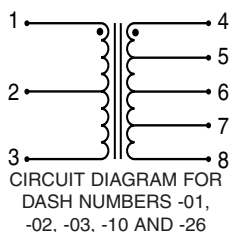
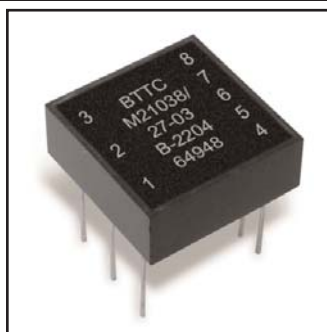

- Notes:
 (1) Dimensions are in inches (mm).
 (2) Unless otherwise specified, tolerance is ±0.010 inches (0.25mm)

TABLE 2. ELECTRICAL CHARACTERISTICS - CONFIGURATION A

BETA P/N	DESC P/N	TURNS RATIO	PRIMARY	SECONDARY	"A" (max)	DC RESISTANCE Ω (MAX)	OUTPUT RISETIME (MAX)	IMPEDANCE Ω (MIN)
B-2202	M-21038/27-01	1:1 ±3% 1:0.707 ±3%	1-3 1-3	4-8 5-7	0.300	1-3 3.0 4-8 3.0	150 ns	(1-3) 4,000
B-2203	M-21038/27-02	1.4:1 ±3% 2:1 ±3%	1-3 1-3	4-8 5-7	0.250	1-3 3.5 4-8 3.0	150 ns	(1-3) 7,200
B-2204	M-21038/27-03	1.25:1 ±3% 1.66:1 ±3%	1-3 1-3	4-8 5-7	0.250	1-3 3.2 4-8 3.0	150 ns	(1-3) 4,000
B-2205	M-21038/27-04	2.3:1 ±3% 3.2:1 ±3%	1-3 1-3	4-8 5-7	0.300	1-3 1.2 4-8 3.0	150 ns	(5-7) 3,000
B-2385	M-21038/27-10	2.12:1 ±3% 1.5:1 ±3%	4-8 5-7	1-3 1-3	0.250	1-3 1.0 4-8 3.0	200 ns	(4-8) 4,000
B-3226	M-21038/27-26	1:2.5 ±3% 1:1.79 ±3%	1-3 1-3	4-8 5-7	0.250	1-3 1.0 4-8 3.5	250 ns	(4-8) 4,000

Note:
 Wave soldering method shall preheat leads to a temperature of 100° C minimum and 140° C maximum at a rate of 2° C per second. Solder wave temperature to be 245° C nominal, 265° C maximum, with a nominal dwell time of 3 seconds and a maximum dwell time of 5 seconds.

CONFIGURATION B

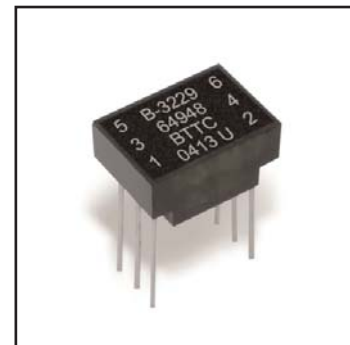
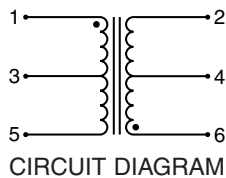
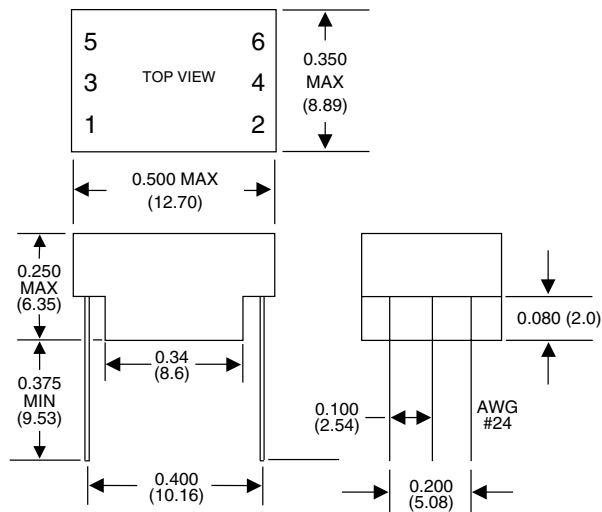

Notes:
 (1) Dimensions are in inches (mm).
 (2) Unless otherwise specified, tolerance is ±0.010 inches (0.25mm)

TABLE 3. ELECTRICAL CHARACTERISTICS - CONFIGURATION B

BETA P/N	DESC P/N	TURNS RATIO	PRIMARY	SECONDARY	DC RESISTANCE Ω (MAX)	OUTPUT RISETIME (MAX)	IMPEDANCE Ω (MIN)
B-2207	M-21038/27-06	1:1 ±3%	1-5	2-6	1-5 2.5 2-6 2.8	150 ns	(1-5) 3,000
B-2208	M-21038/27-07	1:1.41 ±3%	1-5	2-6	1-5 2.2 2-6 2.7	150 ns	(2-6) 3,000
B-2209	M-21038/27-08	1:1.66 ±3%	1-5	2-6	1-5 1.5 2-6 2.4	150 ns	(2-6) 3,000
B-2210	M-21038/27-09	1:2 ±3%	1-5	2-6	1-5 1.3 2-6 2.6	200 ns	(2-6) 3,000
B-3228	M-21038/27-28	1:1.5 ±3%	1-5	2-6	1-5 0.90 2-6 2.5	150 ns	(2-6) 3,000
B-3229	M-21038/27-29	1:1.79 ±3%	1-5	2-6	1-5 0.90 2-6 2.5	150 ns	(2-6) 3,000
B-3230	M-21038/27-30	1:2.5 ±3%	1-5	2-6	1-5 1.0 2-6 2.8	250 ns	(2-6) 3,000

Note:
 Wave soldering method shall preheat leads to a temperature of 100° C minimum and 140° C maximum at a rate of 2° C per second. Solder wave temperature to be 245° C nominal, 265° C maximum, with a nominal dwell time of 3 seconds and a maximum dwell time of 5 seconds.

CONFIGURATION C

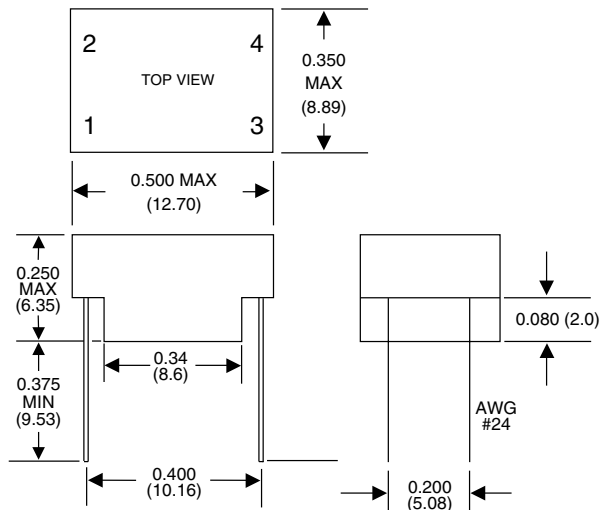
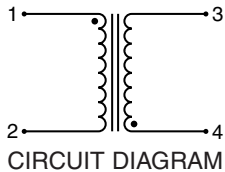
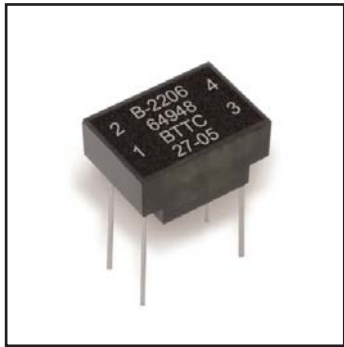

- Notes:
 (1) Dimensions are in inches (mm).
 (2) Unless otherwise specified, tolerance is ±0.010 inches (0.25mm)

TABLE 4. ELECTRICAL CHARACTERISTICS - CONFIGURATION C

BETA P/N	DESC P/N	TURNS RATIO	PRIMARY	SECONDARY	DC RESISTANCE Ω (MAX)	OUTPUT RISE TIME (MAX)	IMPEDANCE Ω (MIN)
B-2206	M-21038/27-05	1:1.41 ±3%	1-2	3-4	1-2 2.2 3-4 2.7	150 ns	(3-4) 3,000

Note:
 Wave soldering method shall preheat leads to a temperature of 100° C minimum and 140° C maximum at a rate of 2° C per second. Solder wave temperature to be 245° C nominal, 265° C maximum, with a nominal dwell time of 3 seconds and a maximum dwell time of 5 seconds.

CONFIGURATION D

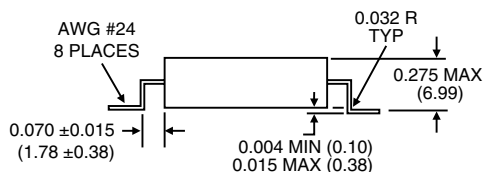
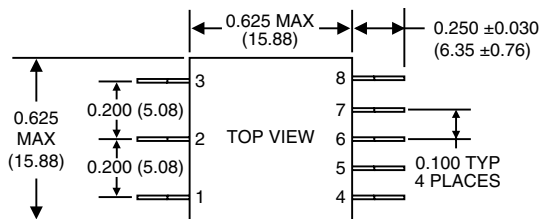
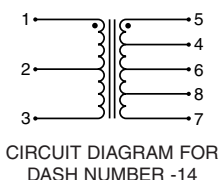
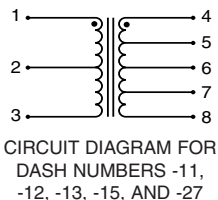
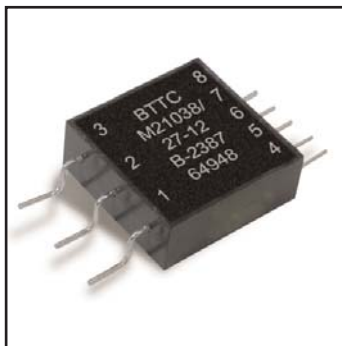

Notes:
 (1) Dimensions are in inches (mm).
 (2) Unless otherwise specified, tolerance is ±0.010 inches (0.25mm)

TABLE 5. ELECTRICAL CHARACTERISTICS - CONFIGURATION D

BETA P/N	DESC P/N	TURNS RATIO	PRIMARY	SECONDARY	DC RESISTANCE Ω (MAX)	OUTPUT RISETIME (MAX)	IMPEDANCE Ω (MIN)
B-2386	M-21038/27-11	1:1 ±3% 1:0.707 ±3%	1-3 1-3	4-8 5-7	1-3 3.0 4-8 3.0	150 ns	(1-3) 4,000
B-2387	M-21038/27-12	1.4:1 ±3% 2:1 ±3%	1-3 1-3	4-8 5-7	1-3 3.5 4-8 3.0	150 ns	(1-3) 7,200
B-2388	M-21038/27-13	1.25:1 ±3% 1.66:1 ±3%	1-3 1-3	4-8 5-7	1-3 3.2 4-8 3.0	150 ns	(1-3) 4,000
B-2389	M-21038/27-14	2.3:1 ±3% 3.2:1 ±3%	4-8 5-7	1-3 1-3	1-3 1.2 4-8 3.0	150 ns	(5-7) 3,000
B-2390	M-21038/27-15	2.12:1 ±3% 1.5:1 ±3%	4-8 5-7	1-3 1-3	1-3 1.0 4-8 3.0	200 ns	(4-8) 4,000
B-3227	M-21038/27-27	1:2.5 ±3% 1:1.79 ±3%	1-3 1-3	4-8 5-7	1-3 1.0 4-8 3.5	250 ns	(4-8) 4,000

Note:
 1) These transformers have been classified as Level 5A per IPC-9503 and must be processed accordingly. To ensure product integrity and maintain the product warranty, these transformers require a 24 hour bake at +125° C prior to any solder reflow processing. Dried transformers must be reflowed within 24 hours. J-STD-033 preconditioning (dry-pack) can be provided by Beta upon request. Reflow process must not cause the peak body temperature of the device to exceed 225° C and must not expose the device to temperatures above 183° C for more than 90 seconds.
 2) By providing surface mount parts that have been dried per IPC-9503 (Moisture Sensitivity Classification for Non-IC components) and Dry-Packed in accordance with J-STD-033 (Standard for handling, packing, shipping and use of Moisture /Reflow sensitive surface mount devices), Beta has significantly reduced the possibility of moisture sensitivity/reflow induced "Pop-corning" or Bulging during customer's reflow soldering process. Experiments performed by Beta and data provided by manufacturers of similar devices indicate that post reflow visual/mechanical anomalies can be reduced by more than 90%. Since customer reflow profiles and CCA Density can vary, Beta recommends that the customer verify solder process compatibility and yield assessment of these devices.

CONFIGURATION E

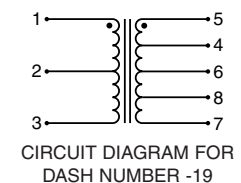
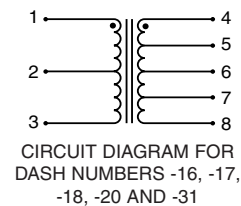
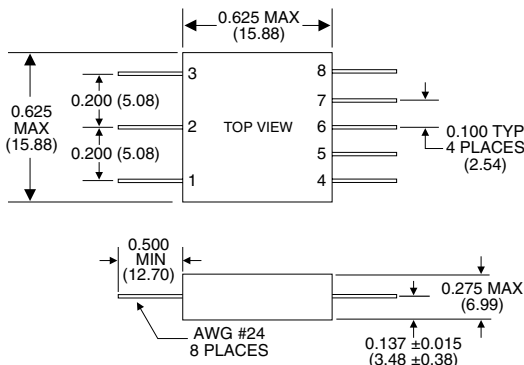
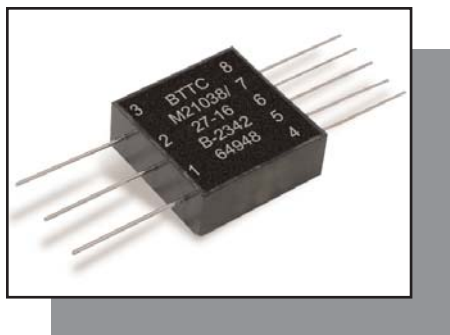

Notes:
 (1) Dimensions are in inches (mm).
 (2) Unless otherwise specified, tolerance is ±0.010 inches (0.25mm)

TABLE 6. ELECTRICAL CHARACTERISTICS - CONFIGURATION E

BETA P/N	DESC P/N	TURNS RATIO	PRIMARY	SECONDARY	DC RESISTANCE Ω (MAX)	OUTPUT RISETIME (MAX)	IMPEDANCE Ω (MIN)
B-2342	M-21038/27-16	1:1 ±3%	1-3	4-8	1-3 3.0	150 ns	(1-3)
		1:0.707 ±3%	1-3	5-7	4-8 3.0		4,000
B-2343	M-21038/27-17	1.4:1 ±3%	1-3	4-8	1-3 3.5	150 ns	(1-3)
		2:1 ±3%	1-3	5-7	4-8 3.0		7,200
B-2344	M-21038/27-18	1.25:1 ±3%	1-3	4-8	1-3 3.2	150 ns	(1-3)
		1.66:1 ±3%	1-3	5-7	4-8 3.0		4,000
B-2345	M-21038/27-19	2.3:1 ±3%	4-8	1-3	1-3 1.2	150 ns	(5-7)
		3.2:1 ±3%	5-7	1-3	4-8 3.0		3,000
B-2391	M-21038/27-20	2.12:1 ±3%	4-8	1-3	1-3 1.0	200 ns	(4-8)
		1.5:1 ±3%	5-7	1-3	4-8 3.0		4,000
B-3231	M-21038/27-31	1:2.5 ±3%	1-3	4-8	1-3 1.0	250 ns	(4-8)
		1:1.79 ±3%	1-3	5-7	4-8 3.5		4,000

Note:
 1) These transformers have been classified as Level 5A per IPC-9503 and must be processed accordingly. To ensure product integrity and maintain the product warranty, these transformers require a 24 hour bake at +125° C prior to any solder reflow processing. Dried transformers must be reflowed within 24 hours. J-STD-033 preconditioning (dry-pack) can be provided by Beta upon request. Reflow process must not cause the peak body temperature of the device to exceed 225° C and must not expose the device to temperatures above 183° C for more than 90 seconds.

2) By providing surface mount parts that have been dried per IPC-9503 (Moisture Sensitivity Classification for Non-IC components) and Dry-Packed in accordance with J-STD-033 (Standard for handling, packing, shipping and use of Moisture /Reflow sensitive surface mount devices), Beta has significantly reduced the possibility of moisture sensitivity/reflow induced "Pop-corning" or Bulging during customer's reflow soldering process. Experiments performed by Beta and data provided by manufacturers of similar devices indicate that post reflow visual/mechanical anomalies can be reduced by more than 90%. Since customer reflow profiles and CCA Density can vary, Beta recommends that the customer verify solder process compatibility and yield assessment of these devices.

CONFIGURATION F

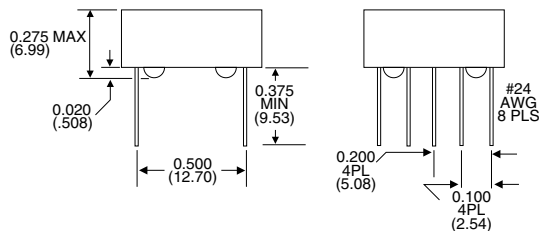
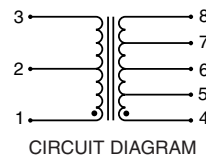
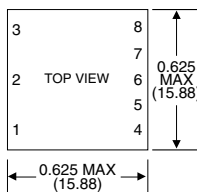
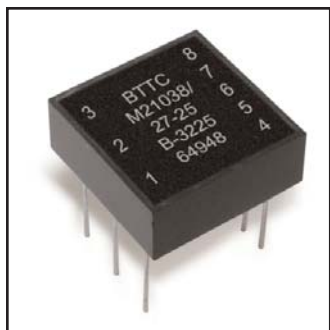

Notes:

- (1) Dimensions are in inches (mm).
- (2) Unless otherwise specified, tolerance is ±0.010 inches (0.25mm)

TABLE 7. ELECTRICAL CHARACTERISTICS - CONFIGURATION F

BETA P/N	DESC P/N	TURNS RATIO	PRIMARY	SECONDARY	DC RESISTANCE Ω (MAX)	OUTPUT RISETIME (MAX)	IMPEDANCE Ω (MIN)
B-3221	M-21038/27-21	1:1 ±3%	1-3	4-8	1-3 3.0	150 ns	(1-3)
		1:0.707 ±3%	1-3	5-7	4-8 3.0		4,000
B-3222	M-21038/27-22	1.4:1 ±3%	1-3	4-8	1-3 3.5	150 ns	(1-3)
		2:1 ±3%	1-3	5-7	4-8 3.0		7,200
B-3223	M-21038/27-23	1.25:1 ±3%	1-3	4-8	1-3 3.2	150 ns	(1-3)
		1.66:1 ±3%	1-3	5-7	4-8 3.0		4,000
B-3224	M-21038/27-24	1:2.12 ±3%	1-3	4-8	1-3 1.2	200 ns	(4-8)
		1:1.50 ±3%	1-3	5-7	4-8 3.0		4,000
B-3225	M-21038/27-25	1:2.5 ±3%	1-3	4-8	1-3 1.0	250 ns	(4-8)
		1:1.79 ±3%	1-3	5-7	4-8 3.5		4,000

Note:
Wave soldering method shall preheat leads to a temperature of 100° C minimum and 140° C maximum at a rate of 2° C per second. Solder wave temperature to be 245° C nominal, 265° C maximum, with a nominal dwell time of 3 seconds and a maximum dwell time of 5 seconds.

The information in this data sheet is believed to be accurate; however, no responsibility is assumed by Beta Transformer Technology Corporation for its use, and no license or rights are granted by implication or otherwise in connection therewith. Specifications are subject to change without notice.

Visit our Web site at www.bttc-beta.com for the latest information



**BETA TRANSFORMER
TECHNOLOGY CORPORATION**

A Subsidiary of Data Device Corporation
40 Orville Drive, Bohemia, NY 11716-2529
Phone: (631) 244-7393; Fax: (631) 244-8893
Web site: www.bttc-beta.com