

The ECS-P143 (3.3V) and ECS-P145 (5V) 14 pin dip DIP is a twice programmable crystal controlled oscillator. The standard 14 pin DIP footprint is ideal for existing PC boards.

FEATURES

- Programmable (1 time)
- 3.3V & 5V options
- PLL technology
- 14 pin DIP footprint
- Extended temp range

PART NUMBERING GUIDE *"EXAMPLE"*

PART NUMBER	SERIES	FREQUENCY (MHz)	STABILITY	EXTENDED TEMP (OPTION)
ECS	P143	- 16.312 -	A	- N

Sample Part Number: ECS-P143-16.312-AN

OPERATING CONDITIONS/ELECTRICAL CHARACTERISTICS

PARAMETERS	CONDITIONS	ECS-P143 (3.3V)			ECS-P145 (5V)			UNITS
		MIN	TYP	MAX	MIN	TYP	MAX	
FREQUENCY RANGE		1.000		125.000	1.000		150.000	MHz
FREQUENCY STABILITY*	Option A			±100			±100	PPM
	Option B			±50			±50	PPM
OPERATING TEMPERATURE	Standard	0		+70	0		+70	°C
	Extended (Option N)	-40		+85	-40		+85	°C
STORAGE TEMPERATURE		-55		+125	-55		+125	°C
INPUT VOLTAGE (Vcc)		+2.97	+3.3	+3.63	+4.5	+5.0	+5.5	VDC
INPUT CURRENT				28			45	mA
OUTPUT SYMMETRY	at 1/2 Vcc LEVEL	40/60		60/40	40/60		60/40	%
RISE AND FALL TIMES	20% Vcc to 80% Vcc			4			4	ns
JITTER	1.0 ~ 33.0 MHz		±100	±250	±100		±250	pS
	> 33.1 MHz		±50	±100	±50		±100	pS
"0" LEVEL				0.4			0.4	VDC
"1" LEVEL		2.7			Vcc - 0.5			VDC
LOAD (HCMOS)	1.0 ~ 50.0 MHz			30			50	pF
	> 50.1 MHz			15			15	pF
ENABLE/DISABLE TIME				150			100	ns
START-UP TIME				10			10	ms

* Inclusive of 25°C tolerance, operating temperature range, input voltage change, load change aging, shock and vibration.

PACKAGE DIMENSIONS (mm)

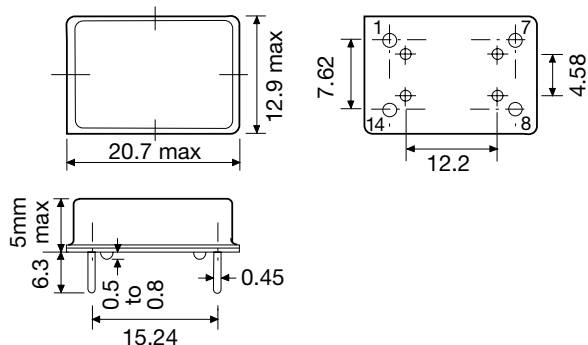

Figure 1) Top, Bottom and Side views

ECS-P143 (3.3V) TRI-STATE CONTROL VOLTAGE	
PIN #1 = OPEN	#3 = OUTPUT
PIN #1 = +0.7V MIN	#3 = OUTPUT
PIN #1 = +0.2V MAX	#3 = HIGH IMPEDANCE

ECS-P145 (5V) TRI-STATE CONTROL VOLTAGE	
PIN #1 = OPEN	#3 = OUTPUT
PIN #1 = +2.0V MIN	#3 = OUTPUT
PIN #1 = +0.8V MAX	#3 = HIGH IMPEDANCE

PIN CONNECTIONS	
#1	TRI-STATE
#7	GND
#8	OUTPUT
#14	VCC