



M.S.KENNEDY CORP.

**RAD TOLERANT
ULTRA LOW DROPOUT
POSITIVE LINEAR REGULATOR**

**5920RH
SERIES**

4707 Dey Road Liverpool, N.Y. 13088

(315) 701-6751

MIL-PRF-38534 CERTIFIED

FEATURES:

- Total Dose Rated to 300K RAD
- Ultra Low Dropout for Reduced Power Consumption
- External Shutdown Function
- Latching Overload Protection
- Available in 1.5V, 1.9V, 2.5V, 2.8V, 3.3V and 5.0V Output Voltages
- Output Current Limit
- Available in 3 Lead Form Options: Straight, Up and Down
- Replaces IR OMR9601

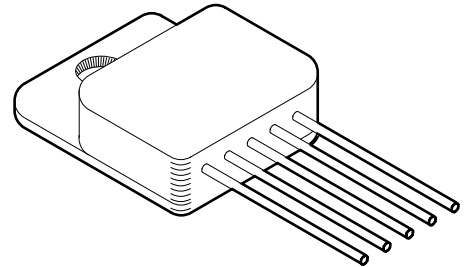

DESCRIPTION:

The MSK 5920RH is a rad tolerant fixed linear regulator capable of delivering 3.0 amps of output current with typical dropout of only 0.30 volts. An external shutdown function is ideal for power supply sequencing. This device also has internal latching overload protection. The MSK 5920RH is radiation tolerant to 300K RAD and specifically designed for many space/satellite applications. The device is packaged in a hermetically sealed space efficient 5 pin SIP that is electrically isolated from the internal circuitry allowing for direct heat sinking.

EQUIVALENT SCHEMATIC

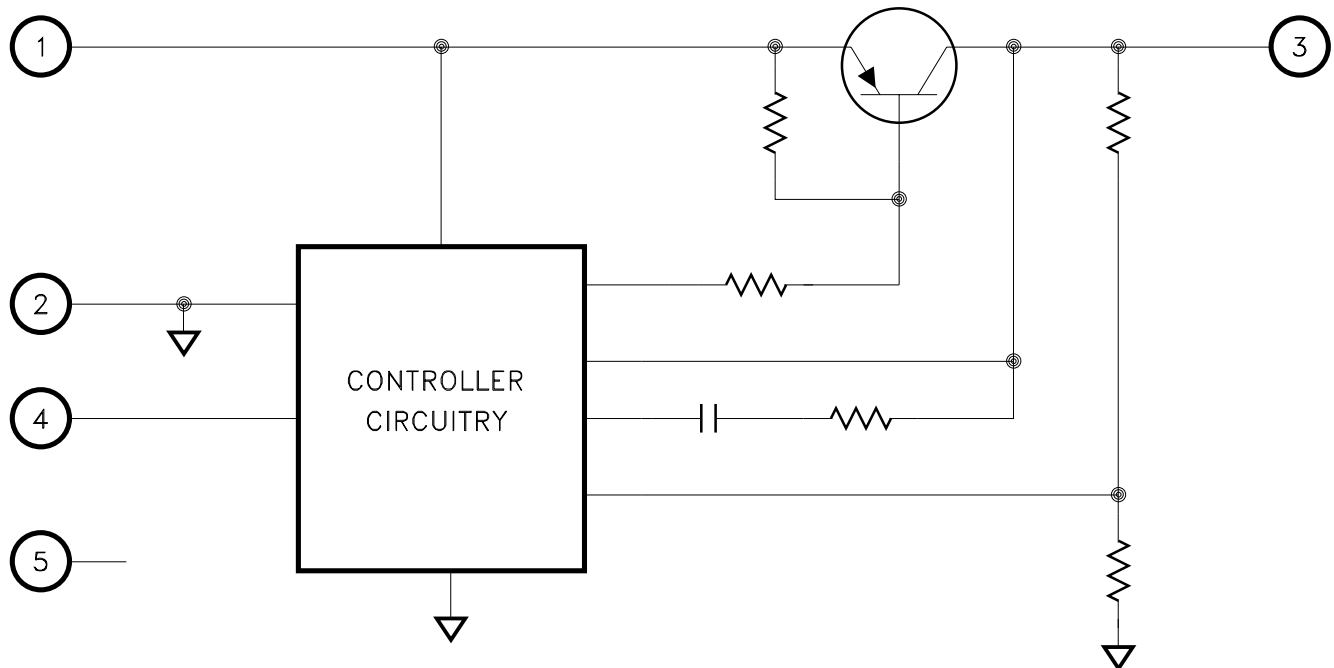

TYPICAL APPLICATIONS

- Satellite System Power Supplies
- Switching Power Supply Post Regulators
- Constant Voltage/Current Regulators
- Microprocessor Power Supplies

PIN-OUT INFORMATION

- 1 VIN
- 2 GND
- 3 VOUT
- 4 SHUTDOWN
- 5 N/C

ABSOLUTE MAXIMUM RATINGS ^⑧

+V _{IN}	Supply Voltage	+10V
I _{OUT}	Output Current ^⑦	5A
T _C	Case Operating Temperature Range	
	MSK5920RH K/H/E	-55°C to +125°C
	MSK5920RH	-40°C to +85°C

T _{ST}	Storage Temperature Range	-65°C to +150°C
T _{LD}	Lead Temperature Range	300°C
	(10 Seconds)	
P _D	Power Dissipation	See SOA Curve
T _C	Junction Temperature	150°C

ELECTRICAL SPECIFICATIONS

Parameter	Test Conditions ^①	Group A Subgroup	MSK5920K/H/E RH			MSK5920RH			Units
			Min.	Typ.	Max.	Min.	Typ.	Max.	
Input Voltage Range ^②	10mA ≤ I _{OUT} ≤ 1.0A	1	2.9	-	6.5	2.9	-	6.5	V
		2,3	2.9	-	6.5	-	-	-	V
Quiescent Current	V _{IN} = 6.5V	1	-	14	20	-	14	20	mA
		2,3	-	14	20	-	-	-	mA
Line Regulation ^⑨	I _{OUT} = 50mA V _{OUT} + 0.4V ≤ V _{IN} ≤ V _{OUT} + 1.3V	1	-	±0.01	±0.50	-	0.01	±0.60	%V _{OUT}
		2,3	-	-	±0.50	-	-	-	%V _{OUT}
Load Regulation ^⑨	50mA ≤ I _{OUT} ≤ 3.0A V _{IN} = V _{OUT} + 1V	1	-	±0.06	±0.80	-	0.06	±1.0	%V _{OUT}
		2,3	-	-	±0.80	-	-	-	%V _{OUT}
Dropout Voltage	Delta V _{OUT} = 1% I _{OUT} = 3.0A	1	-	0.22	0.40	-	0.22	0.45	V
		2,3	-	0.26	0.40	-	-	-	V
Output Current Limit ^{⑦⑨}	V _{IN} = V _{OUT} + 1V Overcurrent Latch Up	1	3.0	-	5	3.0	-	5	A
		2,3	3.0	-	5	-	-	-	A
Shutdown Threshold	V _{OUT} ≤ 0.2V (OFF) V _{OUT} = Nominal (ON)	1	1.0	1.3	1.6	1.0	1.3	1.6	V
		2,3	1.0	1.3	1.6	-	-	-	V
Shutdown Hysteresis	Difference between voltage threshold of V _{SDI} (ON) and V _{SDI} (OFF)	1	-	0.02	0.2	-	0.02	0.2	V
		2,3	-	0.03	0.2	-	-	-	V
Ripple Rejection ^②	f = 120Hz I _{OUT} = 50mA	4	65	-	-	65	-	-	dB
		5,6	65	-	-	-	-	-	dB
Thermal Resistance ^②	Junction to Case @ 125°C Output Device	-	-	2.2	4.0	-	2.2	4.0	°C/W

PART NUMBER	OUTPUT VOLTAGE
MSK5920RH-1.5	+1.5V
MSK5920RH-1.9	+1.9V
MSK5920RH-2.5	+2.5V
MSK5920RH-2.8	+2.8V
MSK5920RH-3.3	+3.3V
MSK5920RH-5.0	+5.0V

NOTES:

- ① Unless otherwise specified, V_{IN} = V_{OUT} + 1V, V_{SHUTDOWN} = 0V and I_{OUT} = 0A. See figure 2 for typical test circuit.
- ② Guaranteed by design but not tested. Typical parameters are representative of actual device performance but are for reference only.
- ③ Industrial grade and "E" suffix devices shall be tested to subgroups 1 and 4 unless otherwise requested.
- ④ Military grade devices ("H" and "K" suffix) shall be 100% tested to subgroups 1,2,3 and 4.
- ⑤ Subgroup 5 and 6 testing available upon request.
- ⑥ Subgroup 1,4 T_C = +25°C
Subgroup 2,5 T_C = +125°C
Subgroup 3,6 T_A = -55°C
- ⑦ Output current limit is dependent upon the values of V_{IN} and V_{OUT}. See Figure 1 and typical performance curves.
- ⑧ Continuous operation at or above absolute maximum ratings may adversely effect the device performance and/or life cycle.
- ⑨ V_{IN} shall be as specified or V_{IN} min., whichever is greater.

APPLICATION NOTES

PIN FUNCTIONS

V_{IN} - This pin provides power to all internal circuitry including bias, start-up, thermal limit and overcurrent latch. Input voltage range is 2.9V to 6.5V.

GND - Internally connected to ground, this pin should be connected externally by the user to the circuit ground.

SHUTDOWN - There are two functions to the SHUTDOWN pin. It may be used to disable the output voltage or to reset a current latch condition. To activate the shutdown/reset functions the user must apply a voltage greater than 1.3V to the SHUTDOWN pin. The output voltage will turn on when the SHUTDOWN pin is pulled below the threshold voltage. If the SHUTDOWN pin is not used, it should be connected to ground. It should be noted that with the shutdown pin tied to ground, a current latch condition can only be reset by cycling power off, then on.

V_{OUT} - This is the output pin for the device.

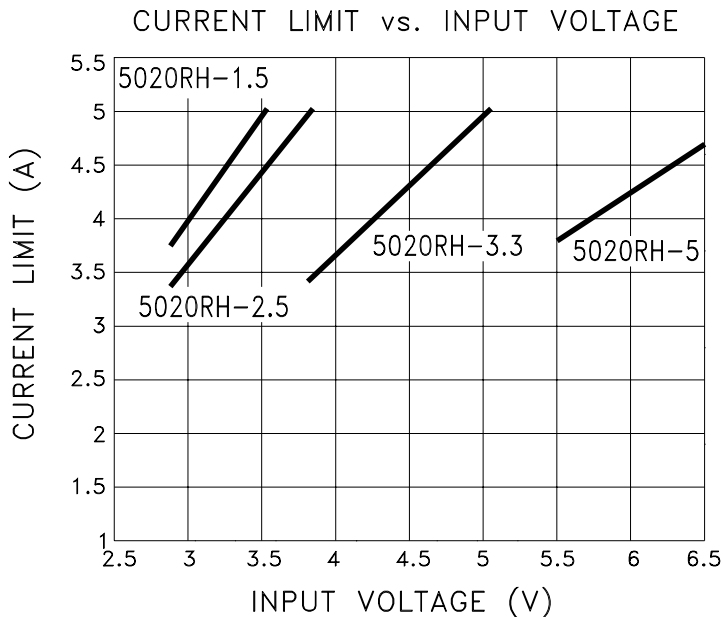

FIGURE 1

OVERCURRENT LATCH

Overcurrent protection is provided by the MSK 5920RH series through the use of a timed latch off circuit. The internal latch timeout is triggered by an overcurrent condition. To allow for start up surge currents, the timeout is approximately 5.5mS at 25°C. If the overcurrent condition remains at the end of the timeout cycle, the regulator will latch off until the latch is reset. The latch condition can be reset by pulling the shutdown pin high or cycling V_{IN} off then back on. A thermal limit condition will trigger the latch with no time out delay.

INPUT POWER SUPPLY BYPASSING

To maximize transient response and minimize power supply transients it is recommended that a 100μF tantalum capacitor is connected between V_{IN} and ground. A 0.1μF ceramic capacitor should also be used for high frequency bypassing.

OUTPUT CAPACITOR SELECTION

Output capacitors are required to maintain regulation and stability. A 220μF surface mount tantalum capacitor in parallel with a 1.0μF ceramic capacitor from the output to ground should suffice under most conditions. If the user finds that tighter voltage regulation is needed during output transients, more capacitance may be added. If more capacitance is added to the output, the bandwidth may suffer.

CURRENT LIMIT AND SOA

The MSK 5920RH current limit function is directly affected by the input and output voltages. Figure 1 illustrates the relationship between V_{IN} and I_{CL} for various output voltages. It is very important for the user to consult the SOA curve when using input voltages which result in current limit conditions beyond 4.5 Amps. When using input voltages which result in current limit above 4.5 Amps, the user must maintain output current within the SOA curve to avoid damage to the device. Note that 5 Amp maximum is due to current carrying capability of the internal wirebonds.

REPLACING THE OMR9601

When the MSK 5920RH-2.5 is used as a replacement for the IR OMR9601, the user should recognize that the MSK 5920RH-2.5 does not contain internal tantalum capacitors on the input and output. MSK does not typically use tantalum capacitors in space level standard products of this nature.

APPLICATION NOTES CONT.

THERMAL LIMITING

The MSK 5920RH control circuitry has a thermal shutdown temperature of approximately 150°C. This thermal shutdown can be used as a protection feature, but for continuous operation, the junction temperature of the pass transistor must be maintained below 150°C. Proper heat sink selection is essential to maintain these conditions.

HEAT SINK SELECTION

To select a heat sink for the MSK 5920RH, the following formula for convective heat flow may be used.

Governing Equation:

$$T_J = P_D \times (R_{\theta JC} + R_{\theta CS} + R_{\theta SA}) + T_A$$

Where

- T_J = Junction Temperature
- P_D = Total Power Dissipation
- R_{θJC} = Junction to Case Thermal Resistance
- R_{θCS} = Case to Heat Sink Thermal Resistance
- R_{θSA} = Heat Sink to Ambient Thermal Resistance
- T_A = Ambient Temperature

$$\text{Power Dissipation} = (V_{IN} - V_{OUT}) \times I_{OUT}$$

Next, the user must select a maximum junction temperature. The absolute maximum allowable junction temperature is 150°C. The equation may now be rearranged to solve for the required heat sink to ambient thermal resistance (R_{θSA}).

Example:

An MSK 5920RH is connected for V_{IN} = +3.3V and V_{OUT} = +2.5V. I_{OUT} is a continuous 3A DC level. The ambient temperature is +25°C. The maximum desired junction temperature is +125°C.

R_{θJC} = 4.0°C/W and R_{θCS} = 0.15°C/W for most thermal greases

$$\begin{aligned} \text{Power Dissipation} &= (3.3V - 2.5V) \times (3A) \\ &= 2.4 \text{ Watts} \end{aligned}$$

Solve for R_{θSA}:

$$\begin{aligned} R_{\theta SA} &= \left[\frac{125^\circ\text{C} - 25^\circ\text{C}}{2.4\text{W}} \right] - 4.0^\circ\text{C/W} - 0.15^\circ\text{C/W} \\ &= 36.5^\circ\text{C/W} \end{aligned}$$

In this example, a heat sink with a thermal resistance of no more than 36.5°C/W must be used to maintain a junction temperature of no more than 125°C.

TYPICAL APPLICATIONS CIRCUIT

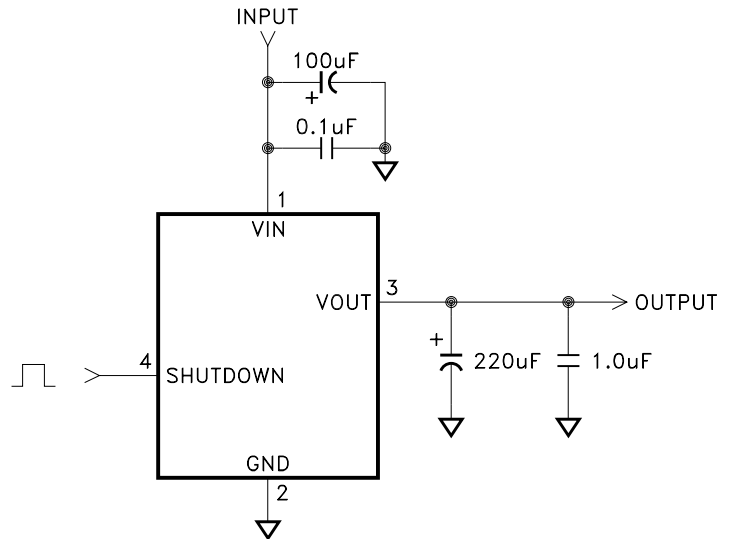
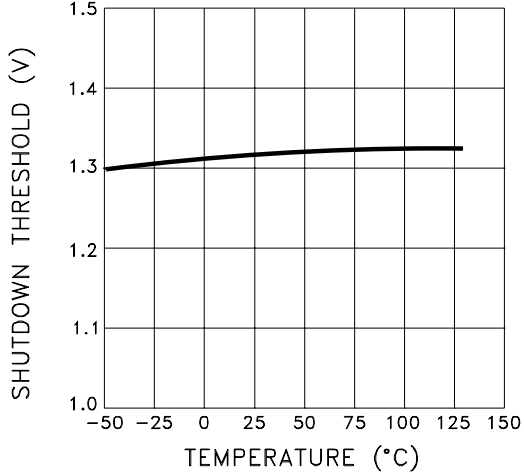

FIGURE 2

TYPICAL PERFORMANCE CURVES

SHUTDOWN VOLTAGE THRESHOLD vs. TEMPERATURE



LATCHING CURRENT vs. INPUT VOLTAGE

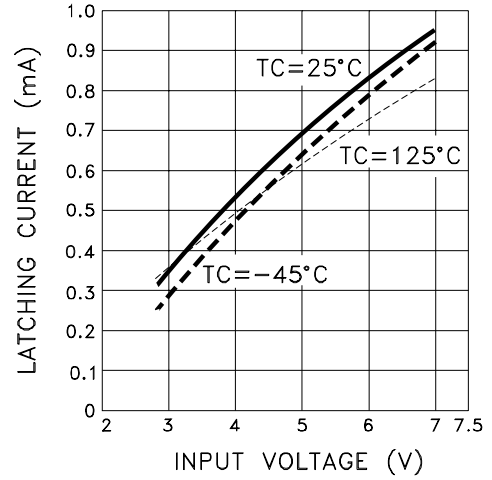

SHUTDOWN PIN CURRENT vs. SHUTDOWN PIN VOLTAGE

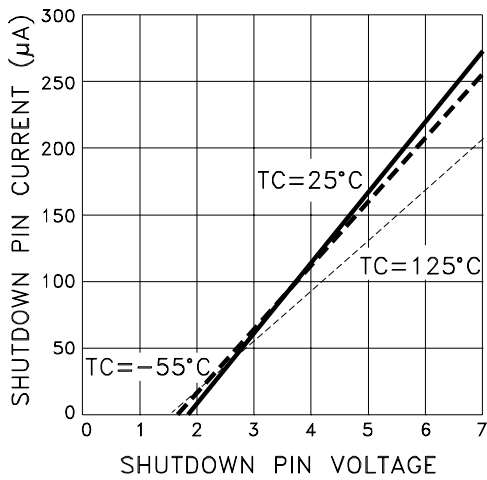

SOA OUTPUT CURRENT vs. VOLTAGE DROP

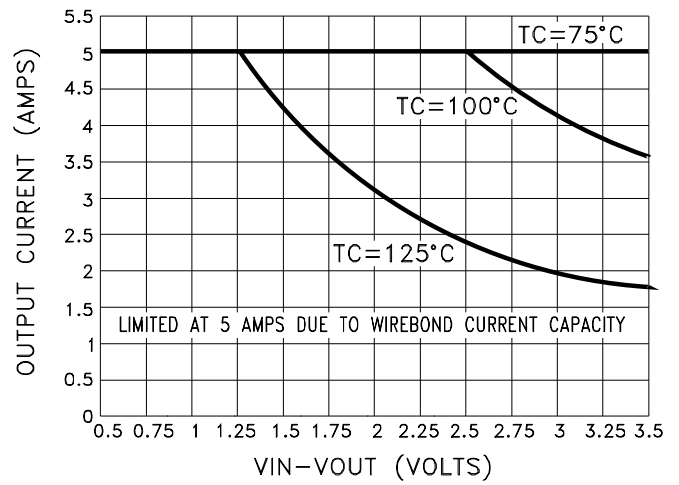

RADIATION PERFORMANCE CURVES

QUIESCENT CURRENT

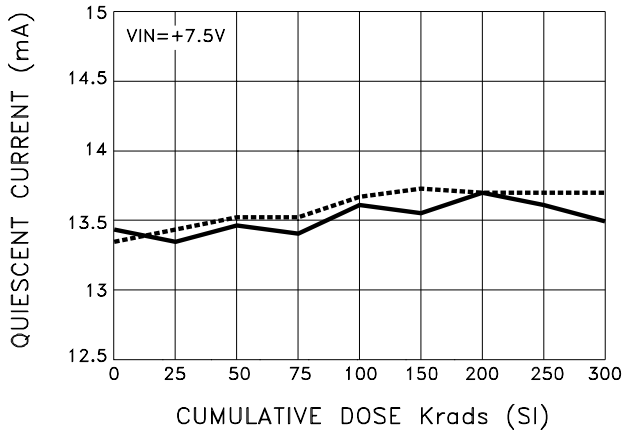

LINE REGULATION

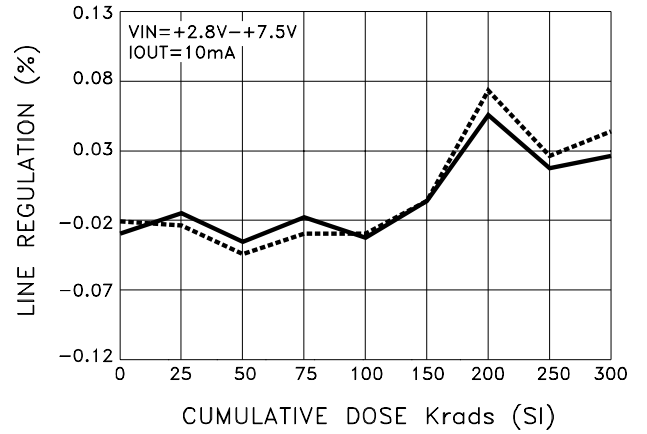

LOAD REGULATION

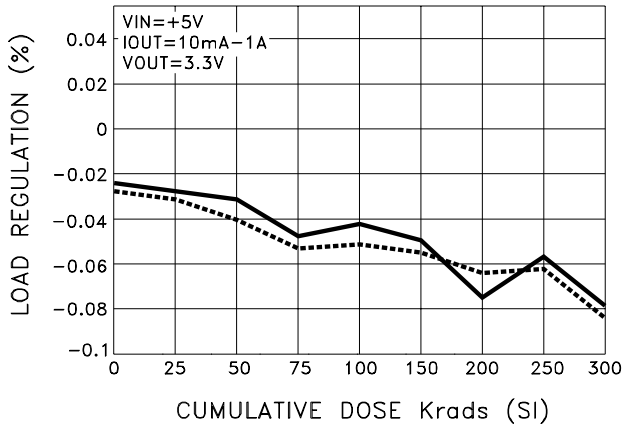

DROPOUT VOLTAGE

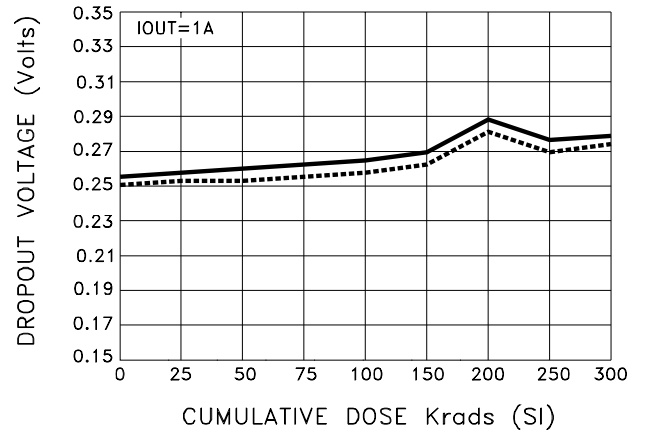

OUTPUT CURRENT LIMIT

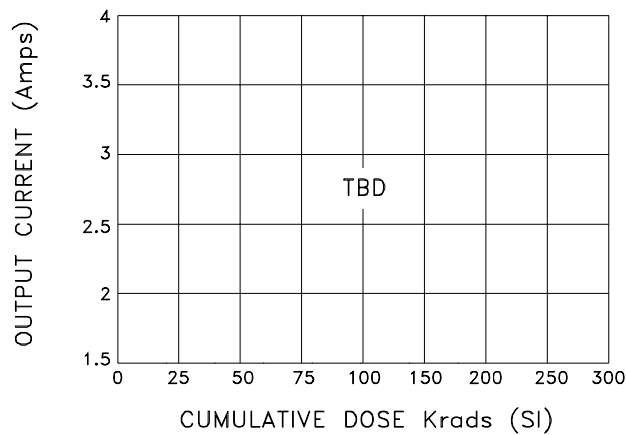

— AVERAGE BIASED
 AVERAGE UNBIASED

MECHANICAL SPECIFICATIONS

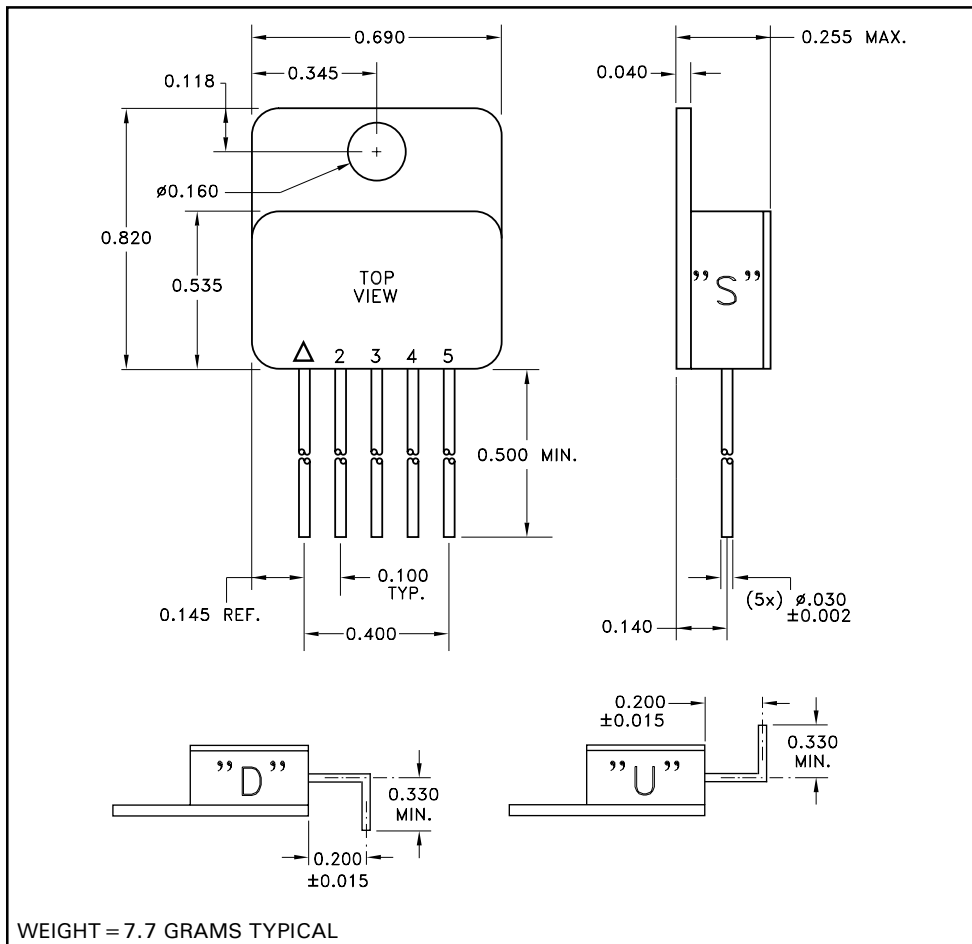

ALL DIMENSIONS ARE ±0.010 INCHES UNLESS OTHERWISE LABELED.
ESD Triangle indicates pin 1.

ORDERING INFORMATION

MSK5920-3.3 K RH U

LEAD CONFIGURATIONS

S = STRAIGHT; U = BENT UP; D = BENT DOWN

RADIATION HARDENED

SCREENING

BLANK = INDUSTRIAL; E = EXTENDED RELIABILITY

H = MIL-PRF-38534 CLASS H; K = MIL-PRF-38534 CLASS K

OUTPUT VOLTAGE

1.5 = +1.5V; 1.9 = +1.9V; 2.5 = +2.5V; 2.8 = +2.8V;

3.3 = +3.3V; 5.0 = +5.0V

GENERAL PART NUMBER

The above example is a +3.3V, Class K regulator with leads bent up.

M.S. Kennedy Corp.

4707 Dey Road, Liverpool, New York 13088

Phone (315) 701-6751

FAX (315) 701-6752

www.mskennedy.com

The information contained herein is believed to be accurate at the time of printing. MSK reserves the right to make changes to its products or specifications without notice, however, and assumes no liability for the use of its products.

Please visit our website for the most recent revision of this datasheet.

Contact MSK for MIL-PRF-38534 Class H, Class K and Appendix G (radiation) status.