

DESCRIPTION

These 500 watt transient voltage suppressors offer capabilities only found in larger packages. They are used for protecting against a variety of transients from inductive switching environments or lower levels of induced secondary lightning effects of IEC61000-4-5. It offers the same size footprint as the popular DO-214AC or BA package outlines except with a much lower profile height. Its robust configuration in a "2010" style MELF package prevents damage to extended-lead terminals and virtually eliminates inductive parasitics from fast rise-time transients with very short internal/external conduction paths. They are also very effective in protection from ESD or EFT per IEC61000-4-2 and IEC61000-4-4.

IMPORTANT: For the most current data, consult MICROSEMI's website: <http://www.microsemi.com>

PACKAGE

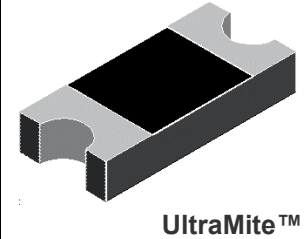

FEATURES

- Available as a unidirectional or bidirectional device (bidirectional with CA suffix)
- Fast response time
- Suppresses transients up to 500 W @ 10/1000 μ s (see Figure 1, 2, and 3).
- Robust 2010 MELF style flat package configuration for accurate pick-and-place handling
- Fits same small narrow PCB pad layouts as "SMAJ" packages in JEDEC DO-214AC (or BA)
- Very low height profile (approximately 1 mm)
- Available on Tape and Reel
- Built-in stress relief with similar COE as PC boards
- Optional Lead-Free design/finish (UMAF5.0A-170CA)
- Options for screening in accordance with MIL-PRF-19500 for JAN, JANTX, JANTXV, and JANS are available by adding MQ, MX, MV, or MSP prefixes respectively to part numbers.

MAXIMUM RATINGS

- Peak Pulse Power dissipation at 25°C: 500 watts at 10/1000 μ s (also see Fig 1, 2, and 3)
- Impulse repetition rate (duty factor): 0.01%
- $t_{clamping}$ (0 volts to $V_{(BR)}$ min.): < 100 ps theoretical for unidirectional and < 5 ns for bidirectional
- Operating and Storage temperature: -55°C to +150°C
- Thermal resistance: 50°C/W junction to lead, or 115°C/W junction to ambient when mounted on FR4 PC board (1oz Cu) with recommended 5 mm² pads (see last page)
- Steady-State Power: 2.5 watts at $T_L = 25^\circ\text{C}$, or 1.08 watts at $T_A = 25^\circ\text{C}$ when mounted on FR4 PC board with recommended 5 mm² footprint pads
- Forward Surge Current at 25°C: 40 amps peak, 8.3 ms half-sine wave. Maximum voltage of 3.50 V (unidirectional only)
- Solder temperatures: 260°C for 10 s (maximum)

APPLICATIONS / BENEFITS

- Protects sensitive components such as IC's, CMOS, Bipolar, BiCMOS, ECL, DTL, T²L, etc.
- Protection from switching transients & induced RF
- Compliant to IEC61000-4-2 and IEC61000-4-4 for ESD and EFT protection respectively
- Secondary lightning protection per IEC61000-4-5 with 42 Ohms source impedance:
 - Class 1: UMA5.0 to UMA100A or CA
 - Class 2: UMA5.0 to UMA51A or CA
 - Class 3: UMA5.0 to UMA24A or CA
 - Class 4: UMA5.0 to UMA12A or CA
- Secondary lightning protection per IEC61000-4-5 with 12 Ohms source impedance:
 - Class 1: UMA5.0 to UMA30A or CA
 - Class 2: UMA5.0 to UMA16A or CA
- Virtually zero inductive parasitics with minimal Ldi/dt voltage overshoots for fast-rise-time transients

MECHANICAL AND PACKAGING

- FRP substrate material and epoxy under-fill package meeting UL94V-0
- Terminals solder plated (solderable per MIL-STD-750, Method 2026)
- Body marked with part number without UMA prefix (ie. 05, 15A, 33A, 58, 150CA, etc.)
- Cathode designated with band (no band on bidirectional)
- Weight: 0.020 grams (approximate)
- Tape & Reel packaging per EIA-481-2 with 12 mm tape and 3000 units/reel (7 inch) or 10,000 units/reel (13 inch)
- See package dimensions on last page

ELECTRICAL CHARACTERISTICS @25°C

MICROSEMI PART NUMBER*	RATED WORKING PEAK STANDOFF VOLTAGE V _{WM} (V)	BREAKDOWN VOLTAGE V _(BR) MIN @ I _(BR) (V)	BREAKDOWN CURRENT I _(BR) (mA)	MAXIMUM CLAMPING VOLTAGE V _C @ I _{PP} (V)	PEAK PULSE CURRENT I _{PP} (A)	MAXIMUM STANDBY CURRENT I _D @ V _{WM} (μA)
UMA5.0A	5.0	6.40	10	9.2	54.3	800
UMA6.0A	6.0	6.67	10	10.3	48.5	800
UMA6.5A	6.5	7.22	10	11.2	44.7	500
UMA7.0A	7.0	7.78	10	12.0	41.7	200
UMA7.5A	7.5	8.33	1	12.9	38.8	100
UMA8.0A	8.0	8.89	1	13.6	36.7	50
UMA8.5A	8.5	9.44	1	14.4	34.7	10
UMA9.0A	9.0	10.0	1	15.4	32.6	5
UMA10A	10	11.1	1	17.0	29.4	5
UMA11A	11	12.2	1	18.2	27.4	5
UMA12A	12	13.3	1	19.9	25.1	5
UMA13A	13	14.4	1	21.5	23.2	5
UMA14A	14	15.6	1	23.2	21.5	5
UMA15A	15	16.7	1	24.4	20.6	5
UMA16A	16	17.8	1	26.0	19.2	5
UMA17A	17	18.9	1	27.6	18.1	5
UMA18A	18	20.0	1	29.2	17.2	5
UMA20A	20	22.2	1	32.4	15.4	5
UMA22A	22	24.4	1	35.5	14.1	5
UMA24A	24	26.7	1	38.9	12.8	5
UMA26A	26	28.9	1	42.1	11.9	5
UMA28A	28	31.1	1	45.4	11.0	5
UMA30A	30	33.3	1	48.4	10.3	5
UMA33A	33	36.7	1	53.3	9.4	5
UMA36A	36	40.0	1	58.1	8.6	5
UMA40A	40	44.4	1	64.5	7.8	5
UMA43A	43	47.8	1	69.4	7.2	5
UMA45A	45	50.0	1	72.7	6.9	5
UMA48A	48	53.3	1	77.4	6.5	5
UMA51A	51	56.7	1	82.4	6.1	5
UMA54A	54	60.0	1	87.1	5.7	5
UMA58A	58	64.4	1	93.6	5.3	5
UMA60A	60	66.7	1	96.8	5.2	5
UMA64A	64	71.1	1	103.0	4.9	5
UMA70A	70	77.8	1	113	4.4	5
UMA75A	75	83.3	1	121	4.1	5
UMA78A	78	86.7	1	126	4.0	5
UMA85A	85	94.4	1	137	3.6	5
UMA90A	90	100	1	146	3.4	5
UMA100A	100	111	1	162	3.1	5
UMA110A	110	122	1	177	2.8	5
UMA120A	120	133	1	193	2.6	5
UMA130A	130	144	1	209	2.4	5
UMA150A	150	167	1	243	2.1	5
UMA160A	160	178	1	259	1.9	5
UMA170A	170	189	1	275	1.8	5

* Order with "CA" suffix for bi-directional types. Capacitance will be ½ that shown in figure 4.

SYMBOLS & DEFINITIONS

Symbol	Definition	Symbol	Definition
V_{WM}	Working Peak (Standoff) Voltage	I_{PP}	Peak Pulse Current
P_{PP}	Peak Pulse Power	V_C	Clamping Voltage
$V_{(BR)}$	Breakdown Voltage	$I_{(BR)}$	Breakdown Current for $V_{(BR)}$
I_D	Standby Current		

GRAPHS

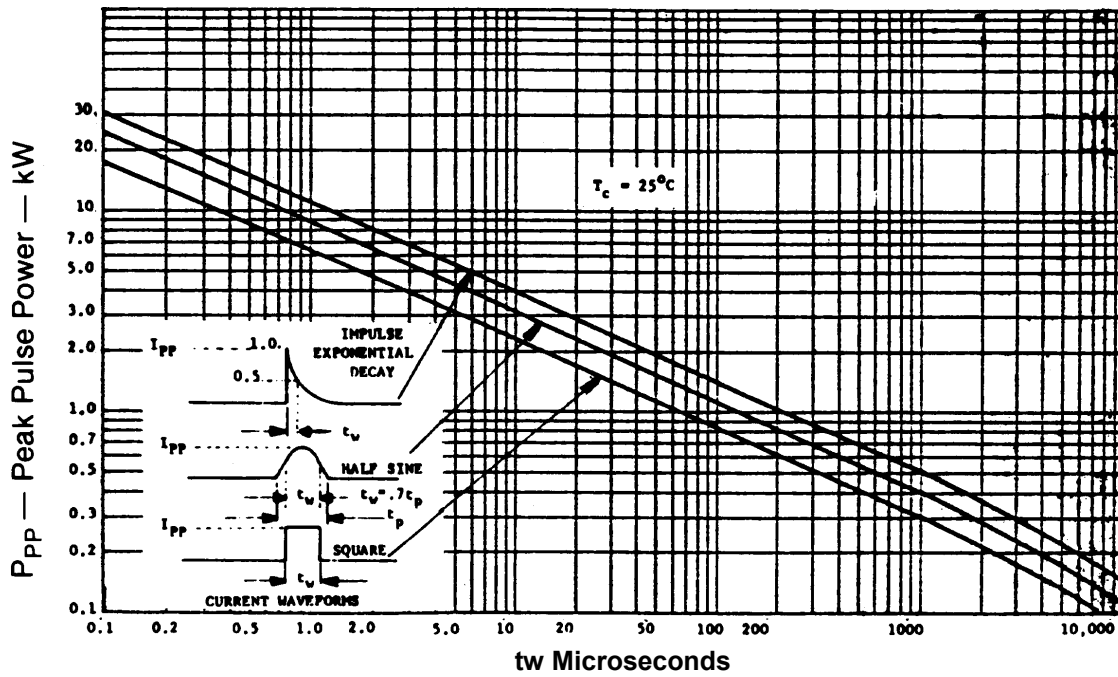

Figure 1 – Peak Pulse Power (P_{PP}) – Kilowatts versus Pulse Width (t_w) - Microseconds

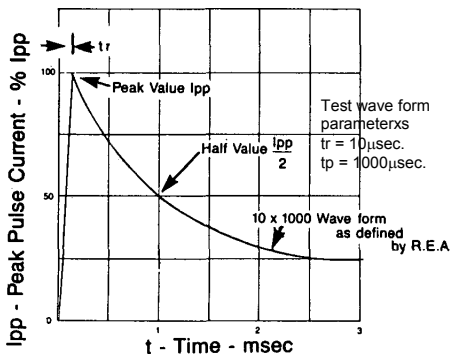

FIGURE 2
Pulse Waveform for Exponential Surge

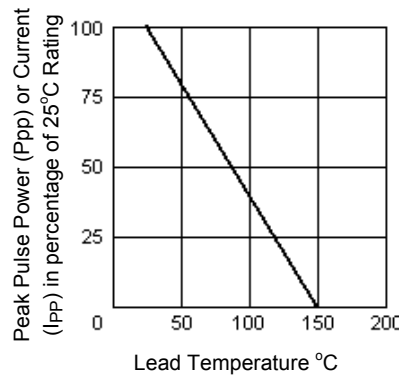

FIGURE 3
Derating Curve

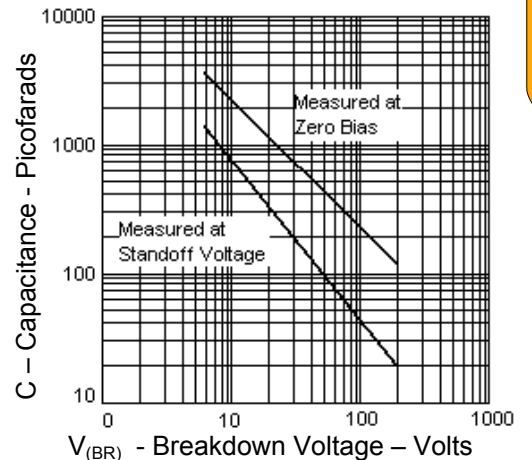
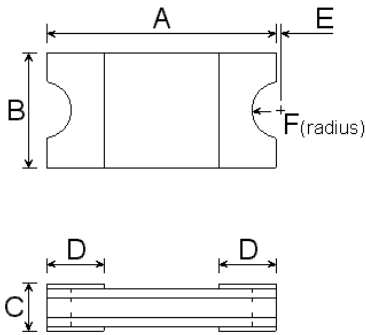

FIGURE 4
Typical Capacitance vs. Breakdown Voltage

PACKAGE DIMENSIONS & PAD LAYOUT



DIM	INCHES		MM	
	MIN	MAX	MIN	MAX
A	.173	.181	4.40	4.60
B	.083	.091	2.10	2.30
C	.033	.045	.85	1.15
D	.033	.045	.85	1.15
E	.002	.002	.05	.05
F	.020	.020	.50	.50

PAD LAYOUT

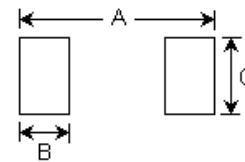

	INCHES	mm
A	.245	6.22
B	.075	1.90
C	.103	2.62