

NCS3402

Dual Nano-power Open Drain Output Comparator

The NCS3402 is a nano-power comparator consuming only 470 nA per channel supply current, which make this device ideal for battery power and wireless handset applications.

The NCS3402 has a minimum operating supply voltage of 2.7 V over the extended industrial temperature range ($T_A = -40^{\circ}\text{C}$ to 125°C), while having an input common-mode range of -0.1 to $V_{DD} + 5$ V.

The ultra low supply current makes the NCS3402 an ideal choice for battery powered and portable applications where quiescent current is the primary concern. Reverse battery protection guards the amplifier from an over-current condition due to improper battery installation. For harsh environments, the inputs can be taken 5 V above the positive supply rail without damage to the device.

Features

- Low Supply Current: 470 nA/Per Channel
 - ◆ Input Common-Mode Range exceeds the rails
 - ◆ -0.1 V to $V_{DD} + 5$ V
- Supply Voltage Range: 2.7 V to 16 V
- Reverse Battery Protection Up to 18 V
- Open Drain CMOS Output Stage
- Specified Temperature Range
 - ◆ -40°C to 125°C
- This is a Pb-Free Device

Typical Applications

- Voltage Sense Circuit
- PSU Monitoring Circuit
- Wireless Handsets
- Portable Medical Equipment



ON Semiconductor®

<http://onsemi.com>

MARKING DIAGRAMS



A = Assembly Location
L = Wafer Lot
Y = Year
W = Work Week
■ = Pb-Free Package

(Note: Microdot may be in either location)

PIN CONNECTIONS

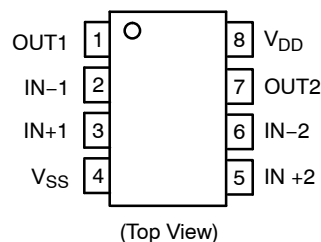

(Top View)

ORDERING INFORMATION

See detailed ordering and shipping information in the package dimensions section on page 7 of this data sheet.

NCS3402

PIN FUNCTION DESCRIPTION

Pin No.	Pin Name	Description
1	OUT1	Channel 1 Output
2	IN-1	Channel 1 Inverting Input
3	IN+2	Channel 2 Non-Inverting Input
4	V _{SS}	Negative Power Supply
5	IN+2	Channel 2 Non-Inverting Input
6	IN-2	Channel 2 Inverting Input
7	OUT2	Channel 2 Output
8	V _{DD}	Positive Power Supply

ABSOLUTE MAXIMUM RATINGS

Rating	Symbol	Value	Unit
Supply Voltage	V _{DD}	17	V
Differential Input Voltage	V _{ID}	±20	V
Input Voltage Range (Notes 1 and 2)	V _{IN}	0 to V _{CC} + 5	V
Input Current Range	I _{IN}	±10	mA
Output Current Range	I _O	±10	mA
Operating Free-Air Temperature Range	T _A	-40 to +125	°C
Maximum Junction Temperature	T _J	150	°C
Storage Temperature Range	T _{STG}	-65 to 150	°C
Lead Temperature 1.6 mm (1/16 inch) from case for 10 seconds	T _{SLD}	260	°C

Stresses exceeding Maximum Ratings may damage the device. Maximum Ratings are stress ratings only. Functional operation above the Recommended Operating Conditions is not implied. Extended exposure to stresses above the Recommended Operating Conditions may affect device reliability.

1. All voltage values, except differential voltages, are respect to GND
2. Input voltage range is limited to 20V or V_{CC} +5 V whichever is smaller

ESD RATINGS

Rating	Symbol	Value	Unit
Human Body Model	HBM	2000	V
Machine Model	MM	200	V

THERMAL CHARACTERISTICS (Note 3)

Rating	Symbol	Value	Unit
Thermal Characteristics Thermal Resistance, Junction-to-Air SOIC8	R _{θJA}	176	°C/W

3. Power dissipation must be considered to ensure the maximum junction temperature (θ_{JA}) is not exceeded.

RECOMMENDED OPERATING CONDITIONS

Parameter	Symbol	Min	Max	Unit	
Supply voltage	V _{DD}	Single supply	2.7	16	V
		Split supply	±1.35	±8	
Common-mode input voltage range	V _{ICR}	-0.1	V _{DD} +5	V	
Operating free-air temperature	T _A	- 40	125	°C	

NCS3402

DC PERFORMANCE ELECTRICAL CHARACTERISTICS AT SPECIFIED OPERATING FREE-AIR TEMPERATURE,

$V_S = 2.7\text{ V}, 5\text{ V}, 15\text{ V}$ (unless otherwise noted)

Parameter	Symbol	Testing Conditions	T_A	Min	Typ	Max	Unit
Input offset voltage	V_{IO}	$V_{CM} = V_S/2, R_S = 50\ \Omega, R_P = 1\text{ M}\Omega$	25°C		250	3600	μV
			Full range			4400	
Offset voltage drift	ΔV_{IO}		25°C		3		$\mu\text{V}/^\circ\text{C}$
Common-mode rejection ratio	CMRR	$V_{CM} = 0\text{ to }2.7\text{ V}, R_S = 50\ \Omega$	25°C	55	72		dB
			Full range	50			
		$V_{CM} = 0\text{ to }5\text{ V}, R_S = 50\ \Omega$	25°C	60	76		
			Full range	55			
		$V_{CM} = 0\text{ to }15\text{ V}, R_S = 50\ \Omega$	25°C	65	88		
			Full range	60			
Large-signal differential voltage amplification	A_{VD}	$R_P = 1\text{ M}\Omega$	25°C		1000		V/mV

INPUT/OUTPUT CHARACTERISTICS SPECIFIED OPERATING FREE-AIR TEMPERATURE,

$V_S = 2.7\text{ V}, 5\text{ V}, 15\text{ V}$ (unless otherwise noted)

Input offset current (Note 4)	I_{IO}	$V_{CM} = V_S/2, R_P = 1\text{ M}\Omega, R_S = 50\ \Omega$	25°C		20	100	pA
			Full range			1000	
Input bias current (Note 4)	I_{IB}		25°C		80	250	pA
			Full range			3000	
Differential input resistance	R_{ID}	$V_{in} = V_S/2$	25°C		300		M Ω
High-impedance output leakage current	I_{OZ}	$V_{CM} = V_S/2, V_O = V_{CC}, V_{ID} = 1\text{ V}$	25°C		50		pA
Low-level output voltage	V_{OL}	$V_{CM} = V_S/2, I_{OL} = 2\ \mu\text{A}, V_{ID} = -1\text{ V}$	25°C		8		mV
			25°C		80	200	
			Full range			300	

POWER SUPPLY SPECIFIED OPERATING FREE-AIR TEMPERATURE, $V_{CC} = 2.7\text{ V}, 5\text{ V}, 15\text{ V}$ (unless otherwise noted)

Supply current (per channel)	I_{CC}	$R_P = \text{No pullup}$	Output state low	25°C		470	550	nA
				Full range			750	
			Output state high	25°C		560	640	
				Full range			950	
Power supply rejection ratio	PSRR	$V_{CM} = V_S/2, \text{No load}$	$V_{CC} = 2.7\text{ V to }5\text{ V}$	25°C	75	100		dB
				Full range	70			
			$V_{CC} = 5\text{ V to }15\text{ V}$	25°C	85	105		
				Full range	80			

4. Guaranteed by design or characterization.

NCS3402

SWITCHING CHARACTERISTICS AT RECOMMENDED OPERATING CONDITIONS,

$V_{CC} = 2.7\text{ V}, 5\text{ V}, 15\text{ V}, T_A = 25^\circ\text{C}$ (unless otherwise noted)

Parameter	Symbol	Testing Conditions	T_A	Min	Typ	Max	Unit	
Propagation delay time, low-to-high-level	$t_{(PLH)}$	$f = 10\text{ kHz},$ $V_{STEP} = 100\text{ mV},$ $R_P = 1\text{ M}\Omega,$ $C_L = 10\text{ pF}$	25°C		220		μs	
					85			
					30			
Propagation delay time, high-to-low-level output	$t_{(PHL)}$			25°C		250		
						55		
						18		
Fall time	t_f	$R_P = 1\text{ M}\Omega, C_L = 10\text{ pF}$		25°C		5		μs

TYPICAL CHARACTERISTICS

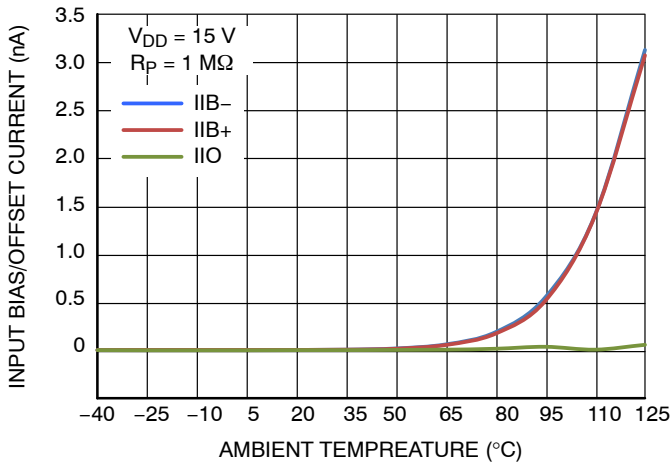

Figure 1. Input Bias/Offset Current vs. Temperature

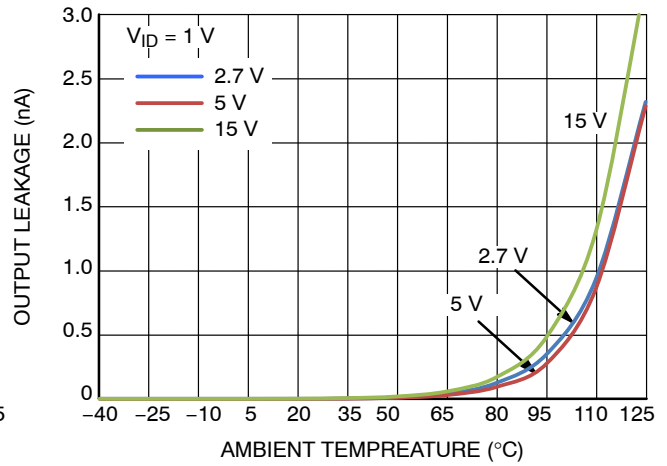

Figure 2. Open Drain Leakage Current vs. Temperature

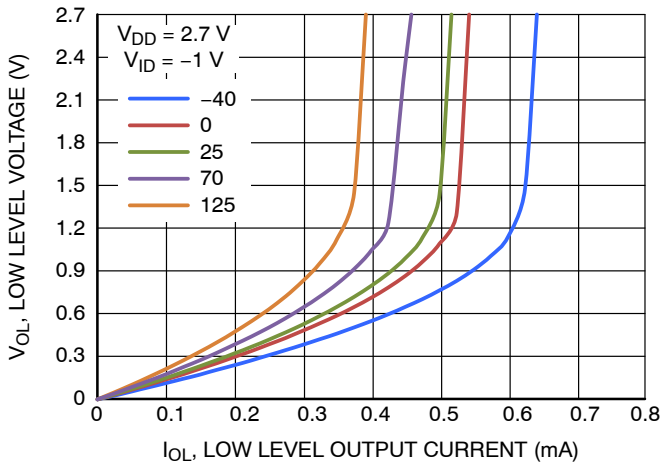

Figure 3. Low Level Output Voltage vs. Low Level Output Current

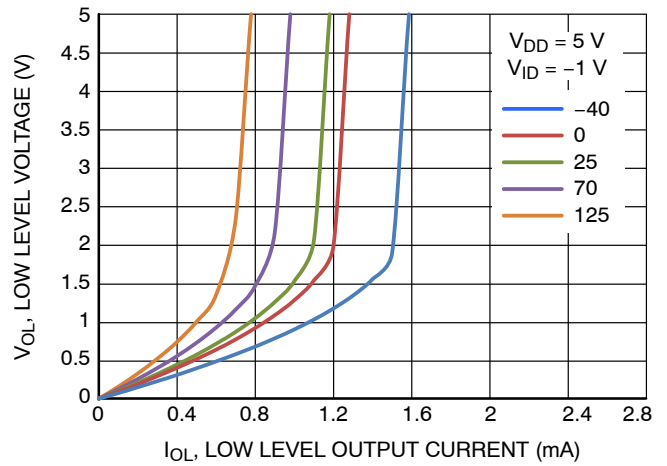

Figure 4. Low Level Output Voltage vs. Low Level Output Current

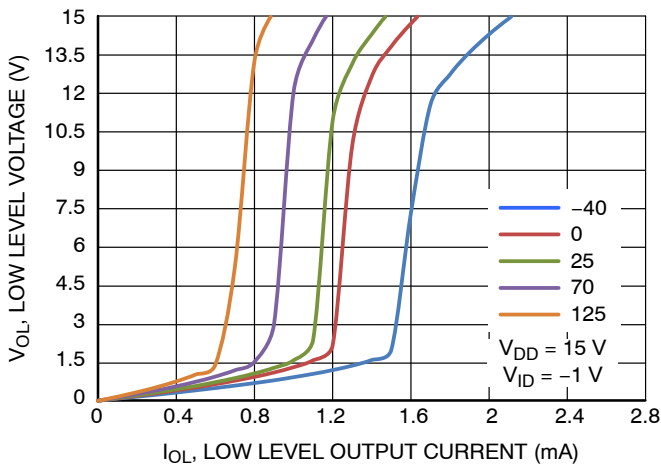

Figure 5. Low Level Output Voltage vs. Low Level Output Current

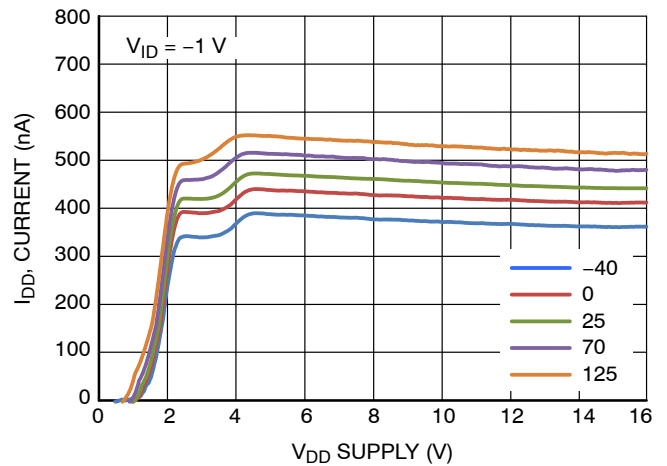

Figure 6. I_{DD} vs. V_{DD} vs. Temperature

TYPICAL CHARACTERISTICS

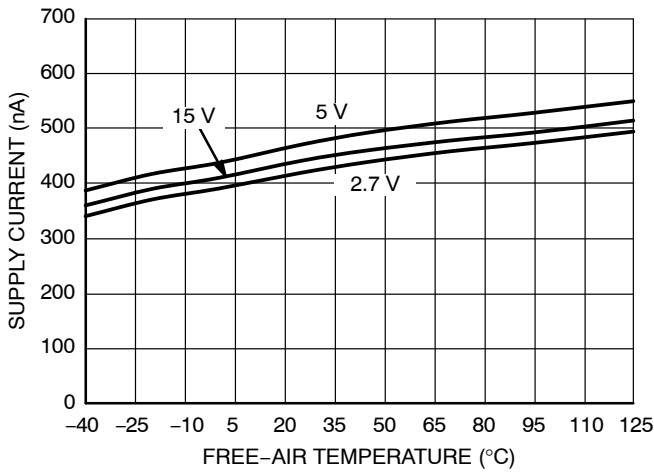

Figure 7. Supply Current vs. Free-Air Temperature

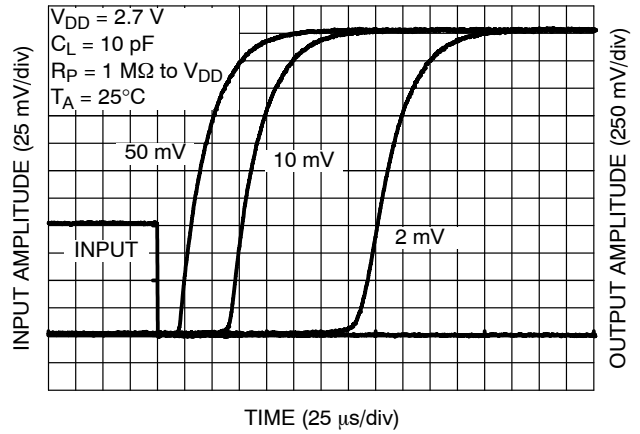

Figure 8. Propagation Delay L-H (2.7 V)

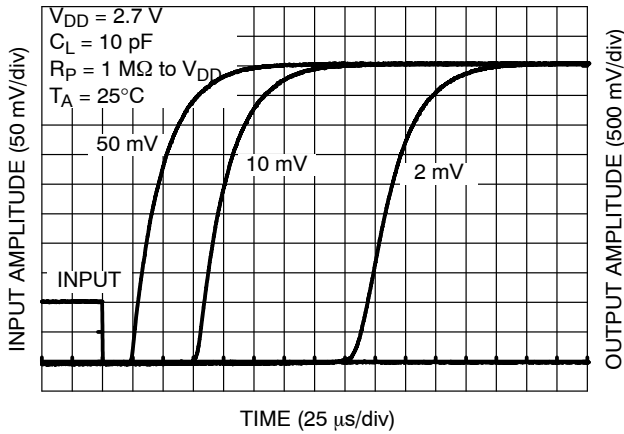

Figure 9. Propagation Delay L-H (5 V)

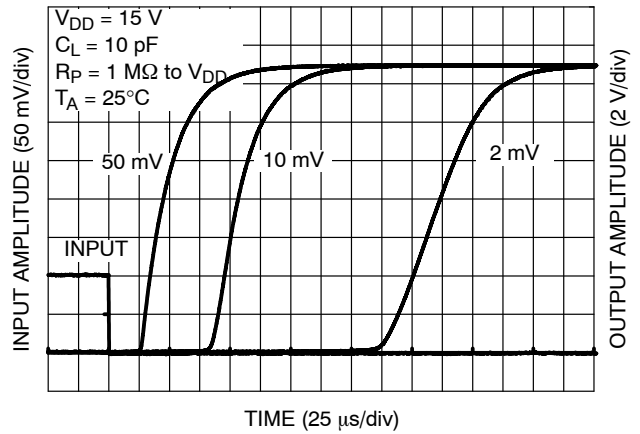

Figure 10. Propagation Delay L-H (15 V)

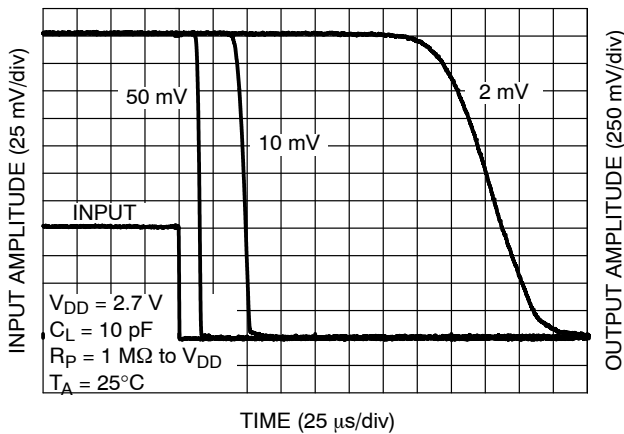

Figure 11. Propagation Delay H-L (2.7 V)

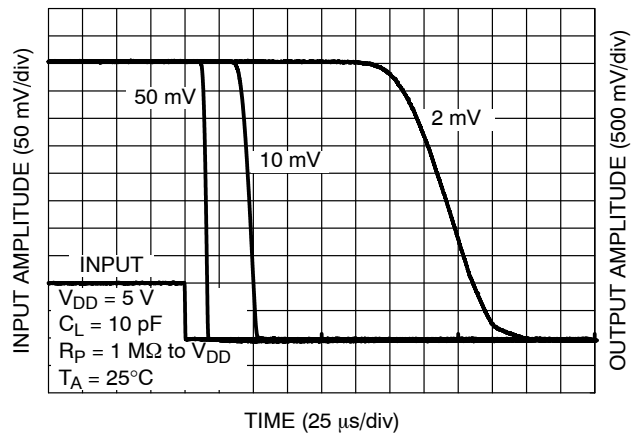
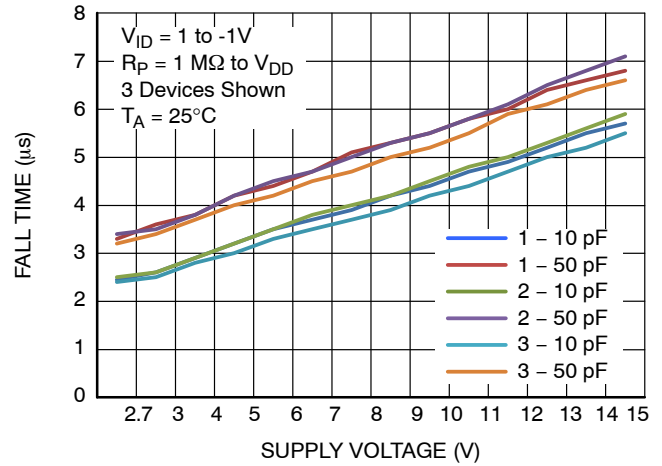
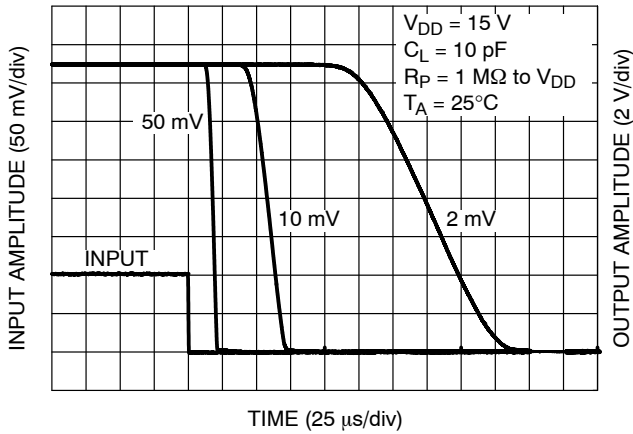

Figure 12. Propagation Delay H-L (5 V)

TYPICAL CHARACTERISTICS



ORDERING INFORMATION

Device	Package	Shipping [†]
NCS3402DR2G	SOIC-8 (Pb-Free)	2500 / Tape & Reel

[†]For information on tape and reel specifications, including part orientation and tape sizes, please refer to our Tape and Reel Packaging Specifications Brochure, BRD8011/D.

NCS3402

PACKAGE DIMENSIONS

SOIC-8 NB CASE 751-07 ISSUE AK

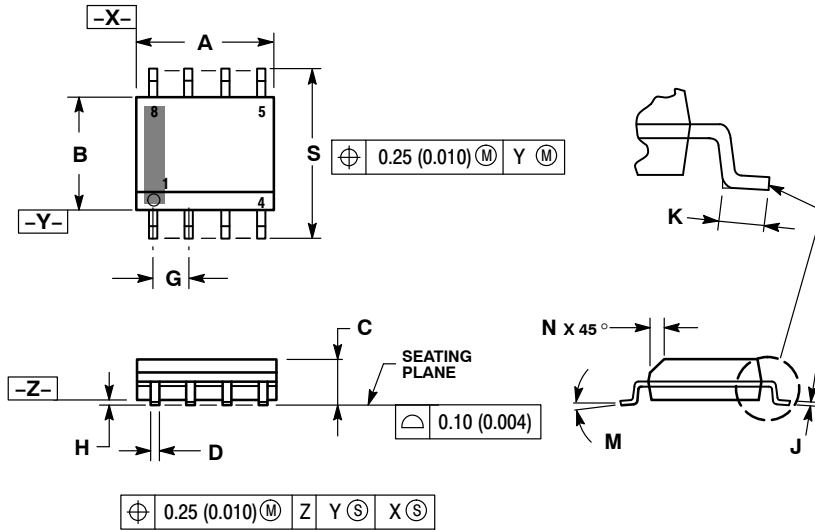

NOTES:

1. DIMENSIONING AND TOLERANCING PER ANSI Y14.5M, 1982.
2. CONTROLLING DIMENSION: MILLIMETER.
3. DIMENSION A AND B DO NOT INCLUDE MOLD PROTRUSION.
4. MAXIMUM MOLD PROTRUSION 0.15 (0.006) PER SIDE.
5. DIMENSION D DOES NOT INCLUDE DAMBAR PROTRUSION. ALLOWABLE DAMBAR PROTRUSION SHALL BE 0.127 (0.005) TOTAL IN EXCESS OF THE D DIMENSION AT MAXIMUM MATERIAL CONDITION.
6. 751-01 THRU 751-06 ARE OBSOLETE. NEW STANDARD IS 751-07.

DIM	MILLIMETERS		INCHES	
	MIN	MAX	MIN	MAX
A	4.80	5.00	0.189	0.197
B	3.80	4.00	0.150	0.157
C	1.35	1.75	0.053	0.069
D	0.33	0.51	0.013	0.020
G	1.27 BSC		0.050 BSC	
H	0.10	0.25	0.004	0.010
J	0.19	0.25	0.007	0.010
K	0.40	1.27	0.016	0.050
M	0°	8°	0°	8°
N	0.25	0.50	0.010	0.020
S	5.80	6.20	0.228	0.244

SOLDERING FOOTPRINT*

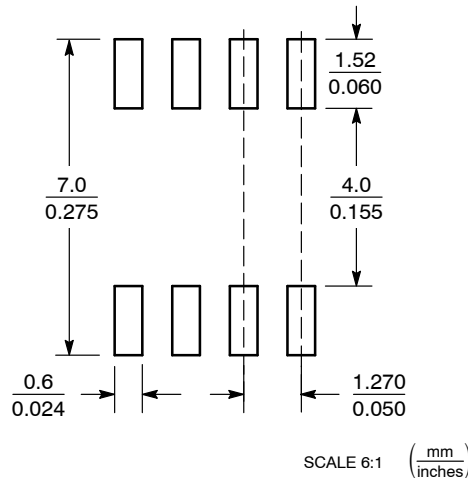

*For additional information on our Pb-Free strategy and soldering details, please download the ON Semiconductor Soldering and Mounting Techniques Reference Manual, SOLDERRM/D.

ON Semiconductor and are registered trademarks of Semiconductor Components Industries, LLC (SCILLC). SCILLC owns the rights to a number of patents, trademarks, copyrights, trade secrets, and other intellectual property. A listing of SCILLC's product/patent coverage may be accessed at www.onsemi.com/site/pdf/Patent-Marking.pdf. SCILLC reserves the right to make changes without further notice to any products herein. SCILLC makes no warranty, representation or guarantee regarding the suitability of its products for any particular purpose, nor does SCILLC assume any liability arising out of the application or use of any product or circuit, and specifically disclaims any and all liability, including without limitation special, consequential or incidental damages. "Typical" parameters which may be provided in SCILLC data sheets and/or specifications can and do vary in different applications and actual performance may vary over time. All operating parameters, including "Typicals" must be validated for each customer application by customer's technical experts. SCILLC does not convey any license under its patent rights nor the rights of others. SCILLC products are not designed, intended, or authorized for use as components in systems intended for surgical implant into the body, or other applications intended to support or sustain life, or for any other application in which the failure of the SCILLC product could create a situation where personal injury or death may occur. Should Buyer purchase or use SCILLC products for any such unintended or unauthorized application, Buyer shall indemnify and hold SCILLC and its officers, employees, subsidiaries, affiliates, and distributors harmless against all claims, costs, damages, and expenses, and reasonable attorney fees arising out of, directly or indirectly, any claim of personal injury or death associated with such unintended or unauthorized use, even if such claim alleges that SCILLC was negligent regarding the design or manufacture of the part. SCILLC is an Equal Opportunity/Affirmative Action Employer. This literature is subject to all applicable copyright laws and is not for resale in any manner.

PUBLICATION ORDERING INFORMATION

LITERATURE FULFILLMENT:
 Literature Distribution Center for ON Semiconductor
 P.O. Box 5163, Denver, Colorado 80217 USA
Phone: 303-675-2175 or 800-344-3860 Toll Free USA/Canada
Fax: 303-675-2176 or 800-344-3867 Toll Free USA/Canada
Email: orderlit@onsemi.com

N. American Technical Support: 800-282-9855 Toll Free
 USA/Canada
Europe, Middle East and Africa Technical Support:
 Phone: 421 33 790 2910
Japan Customer Focus Center
 Phone: 81-3-5817-1050

ON Semiconductor Website: www.onsemi.com
Order Literature: <http://www.onsemi.com/orderlit>

For additional information, please contact your local Sales Representative

Mouser Electronics

Authorized Distributor

Click to View Pricing, Inventory, Delivery & Lifecycle Information:

[ON Semiconductor:](#)

[NCS3402DR2G](#)