

## Radiation Hardened Inverting Octal Three-State Buffer/Line Driver

September 1995

### Features

- 3 Micron Radiation Hardened SOS CMOS
- Total Dose 200K RAD (Si)
- SEP Effective LET No Upsets: >100 MEV-cm<sup>2</sup>/mg
- Single Event Upset (SEU) Immunity < 2 x 10<sup>-9</sup> Errors/Bit-Day (Typ)
- Dose Rate Survivability: >1 x 10<sup>12</sup> RAD (Si)/s
- Dose Rate Upset >10<sup>10</sup> RAD (Si)/Sec. 20ns Pulse
- Latch Up Free Under Any Conditions
- Military Temperature Range: -55°C to +125°C
- Significant Power Reduction Compared to LSTTL ICs
- DC Operating Voltage Range: 4.5V to 5.5V
- Input Logic Levels
  - VIL = 30% VCC Max
  - VIH = 70% VCC Min
- Input Compatibility Levels I<sub>i</sub> ≤ 5μA at VOL, VOH

### Description

The Harris HCS241MS is a Radiation Hardened inverting octal three-state buffer/line driver with two output enables, one active low, and one active high.

The HCS241MS utilizes advanced CMOS/SOS technology to achieve high-speed operation. This device is a member of radiation hardened, high-speed, CMOS/SOS Logic Family.

The HCS241MS is supplied in a 20 lead ceramic flatpack (K suffix) or a SBDIP package (D suffix).

### Pinouts

20 LEAD CERAMIC DUAL-IN-LINE METAL SEAL PACKAGE (SBDIP)  
MIL-STD-1835 CDIP2-T20, LEAD FINISH C  
TOP VIEW

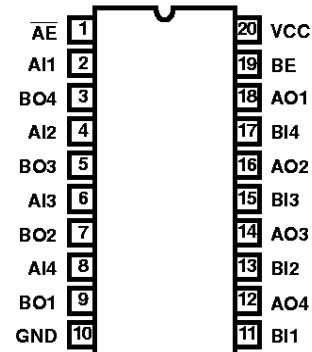

20 LEAD CERAMIC METAL SEAL FLATPACK PACKAGE (FLATPACK)  
MIL-STD-1835 CDFP4-F20, LEAD FINISH C  
TOP VIEW

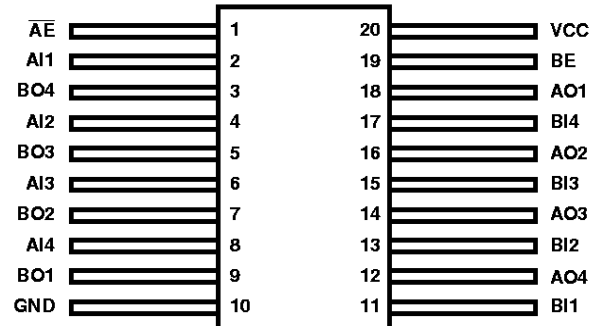

### Ordering Information

PART NUMBER	TEMPERATURE RANGE	SCREENING LEVEL	PACKAGE
HCS241DMSR	-55°C to +125°C	Harris Class S Equivalent	20 Lead SBDIP
HCS241KMSR	-55°C to +125°C	Harris Class S Equivalent	20 Lead Ceramic Flatpack
HCS241D/Sample	+25°C	Sample	20 Lead SBDIP
HCS241K/Sample	+25°C	Sample	20 Lead Ceramic Flatpack
HCS241HMSR	+25°C	Die	Die

# HCS241MS

## Functional Diagram

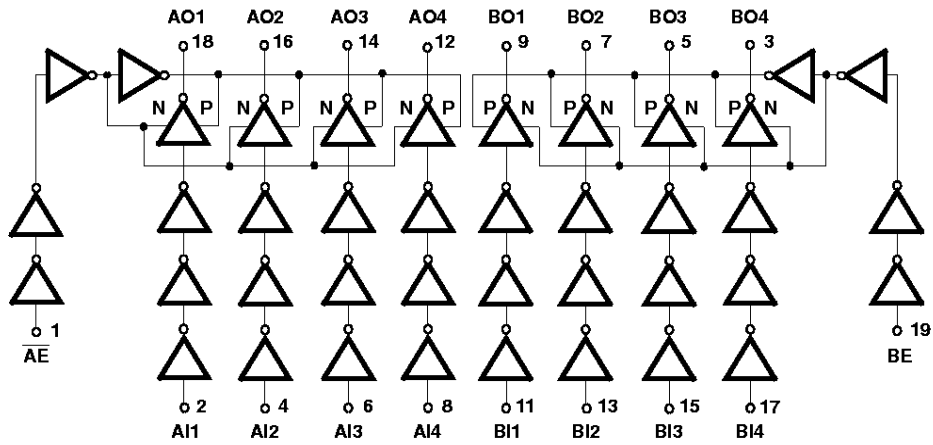

TRUTH TABLE

INPUTS		OUTPUT	INPUTS		OUTPUT
$\overline{AE}$	AIn	AOn	BE	BIn	BOn
L	L	L	L	X	Z
L	H	H	H	L	L
H	X	Z	H	H	H

H = High Voltage Level  
 L = Low Voltage Level  
 X = Immaterial  
 Z = High Impedance

# Specifications HCS241MS

## Absolute Maximum Ratings

Supply Voltage	-0.5V to +7.0V
Input Voltage Range, All Inputs	-0.5V to VCC +0.5V
DC Input Current, Any One Input	±10mA
DC Drain Current, Any One Output (All Voltage Reference to the VSS Terminal)	±35mA
Storage Temperature Range (TSTG)	-65°C to +150°C
Lead Temperature (Soldering 10 sec)	+265°C
Junction Temperature (TJ)	+175°C
ESD Classification	Class 1

## Reliability Information

Thermal Resistance	$\theta_{JA}$	$\theta_{JC}$
SBDIP Package	72°C/W	24°C/W
Ceramic Flatpack Package	107°C/W	28°C/W
Maximum Package Power Dissipation at +125°C Ambient		
SBDIP Package	0.69W	
Ceramic Flatpack Package	0.47W	
If device power exceeds package dissipation capability, provide heat sinking or derate linearly at the following rate:		
SBDIP Package	13.9mW/°C	
Ceramic Flatpack Package	9.3mW/°C	
Gate Count	40 Gates	

*CAUTION: As with all semiconductors, stress listed under "Absolute Maximum Ratings" may be applied to devices (one at a time) without resulting in permanent damage. This is a stress rating only. Exposure to absolute maximum rating conditions for extended periods may affect device reliability. The conditions listed under "Electrical Performance Characteristics" are the only conditions recommended for satisfactory device operation.*

## Operating Conditions

Supply Voltage	+4.5V to +5.5V	Input Low Voltage (VIL)	0.0V to 30% of VCC
Input Rise and Fall Times at 4.5V VCC (TR, TF)	100ns/V Max	Input High Voltage (VIH)	VCC to 70% of VCC
Operating Temperature Range (TA)	-55°C to +125°C		

**TABLE 1. DC ELECTRICAL PERFORMANCE CHARACTERISTICS**

PARAMETER	SYMBOL	CONDITIONS	GROUP A SUB-GROUPS	TEMPERATURE	LIMITS		UNITS
					MIN	MAX	
Supply Current	ICC	VCC = 5.5V, VIN = VCC or GND	1	+25°C	-	40	μA
			2, 3	+125°C, -55°C	-	750	
Output Current (Sink)	IOL	VCC = VIH = 4.5V, VOUT = 0.4V, VIL = 0 (Note 2)	1	+25°C	7.2	-	mA
			2, 3	+125°C, -55°C	6.0	-	
Output Current (Source)	IOH	VCC = VIH = 4.5V, VOUT = VCC - 0.4V, VIL = 0 (Note 2)	1	+25°C	-7.2	-	mA
			2, 3	+125°C, -55°C	-6.0	-	
Output Voltage Low	VOL	VCC = 4.5V, VIH = 3.15V, VIL = 1.35V, IOL = 50μA	1, 2, 3	+25°C, +125°C, -55°C	-	0.1	V
		VCC = 5.5V, VIH = 3.85V, VIL = 1.65V, IOL = 50μA	1, 2, 3	+25°C, +125°C, -55°C	-	0.1	V
Output Voltage High	VOH	VCC = 4.5V, VIH = 3.15V, VIL = 1.35V, IOH = -50μA	1, 2, 3	+25°C, +125°C, -55°C	VCC- 0.1	-	V
		VCC = 5.5V, VIH = 3.85V, VIL = 1.35V, IOH = -50μA	1, 2, 3	+25°C, +125°C, -55°C	VCC- 0.1	-	V
Input Leakage Current	IIN	VCC = 5.5V VIN = VCC or GND	1	+25°C	-	±0.5	μA
			2, 3	+125°C, -55°C	-	±5.0	
Three-State Output Leakage Current	IOZ	VCC = 5.5V, Force Voltage = 0V or VCC	1	+25°C	-	±1.0	μA
			2, 3	+125°C, -55°C	-	±5.0	
Noise Immunity Functional Test	FN	VCC = 4.5V, VIH = 3.15V, VIL = 1.35V (Note 3)	7, 8A, 8B	+25°C, +125°C, -55°C	-	-	-

**NOTES:**

1. All voltages referenced to device GND.
2. Force/Measure function may be interchanged.
3. For functional tests, VO ≥ 4.0V is recognized as a logic "1", and VO ≤ 0.5V is recognized as a logic "0".

## Specifications HCS241MS

**TABLE 2. AC ELECTRICAL PERFORMANCE CHARACTERISTICS**

PARAMETER	SYMBOL	(NOTES 1, 2) CONDITIONS	GROUP A SUB- GROUPS	TEMPERATURE	LIMITS		UNITS
					MIN	MAX	
Propagation Delay	TPLH1	VCC = 4.5V, VIH = 4.5V, VIL = 0V	9	+25°C	2	21	ns
			10, 11	+125°C, -55°C	2	25	
Propagation Delay	TPHL1	VCC = 4.5V, VIH = 4.5V, VIL = 0V	9	+25°C	2	21	ns
			10, 11	+125°C, -55°C	2	25	
Propagation Delay	TPZL1 TPZL2	VCC = 4.5V, VIH = 4.5V, VIL = 0	9	+25°C	2	25	ns
			10, 11	+125°C, -55°C	2	30	
Propagation Delay	TPLZ1 TPLZ2	VCC = 4.5V, VIH = 4.5V, VIL = 0	9	+25°C	2	25	ns
			10, 11	+125°C, -55°C	2	30	
Propagation Delay	TPZH1 TPZH2	VCC = 4.5V, VIH = 4.5V, VIL = 0	9	+25°C	2	20	ns
			10, 11	+125°C, -55°C	2	24	
Propagation Delay	TPHZ1 TPHZ2	VCC = 4.5V, VIH = 4.5V, VIL = 0	9	+25°C	2	25	ns
			10, 11	+125°C, -55°C	2	30	

**NOTES:**

1. All voltage referenced to GND.
2. Measurements made with CL = 50pF, RL = 500Ω, Input TR = TF = 3ns

**TABLE 3. ELECTRICAL PERFORMANCE CHARACTERISTICS**

PARAMETER	SYMBOL	CONDITIONS	NOTE	TEMPERATURE	LIMITS		UNITS
					MIN	MAX	
Capacitance Power Dissipation	CPD	VCC = 5V, VIH = 5V, VIL = 0V, f = 1MHz	1	+25°C	-	36	pF
			1	+125°C, -55°C	-	59	pF
Input Capacitance	CIN	VCC = 5V, VIH = 5V, VIL = 0V, f = 1MHz	1	+25°C	-	10	pF
			1	+125°C, -55°C	-	10	pF
Output Capacitance	COUT	VCC = 5V, VIH = 5V, VIL = 0V, f = 1MHz	1	+25°C	-	20	pF
			1	+125°C, -55°C	-	20	pF

**NOTE:**

1. The parameters listed in Table 3 are controlled via design or process parameters. Min and Max Limits are guaranteed but not directly tested. These parameters are characterized upon initial design release and upon design changes which would affect these characteristics.

## Specifications HCS241MS

**TABLE 4. DC POST RADIATION ELECTRICAL PERFORMANCE CHARACTERISTICS**

PARAMETER	SYMBOL	(NOTES 1, 2) CONDITIONS	TEMPERATURE	200K RAD LIMITS		UNITS
				MIN	MAX	
Supply Current	ICC	VIN = 5.5V, VIN = VCC or GND	+25°C	-	0.75	mA
Output Current (Sink)	IOL	VCC = VIH = 4.5V, VOUT = 0.4V, VIL = 0	+25°C	6	-	mA
Output Current (Source)	IOH	VCC = VIH = 4.5V, VOUT = VCC - 0.4V, VIL = 0	+25°C	-6	-	mA
Output Voltage Low	VOL	VCC = 4.5V, VIH = 3.15V, VIL = 1.35V, IOL = 50µA	+25°C	-	0.1	V
		VCC = 5.5V, VIH = 3.85V, VIL = 1.65V, IOL = 50µA		-	0.1	V
Output Voltage High	VOH	VCC = 4.5V, VIH = 3.15V, VIL = 1.35V, IOH = -50µA	+25°C	VCC- 0.1	-	V
		VCC = 5.5V, VIH = 3.85V, VIL = 1.65V, IOH = -50µA		VCC- 0.1	-	V
Three-State Output Leakage Current	IOZ	VCC = 5.5V, Force Voltage = 0V or VCC	+25°C	-	±50	µA
Input Leakage Current	IIN	VCC = 5.5V, VIN = VCC or GND	+25°C	-	±5	µA
Noise Immunity Functional	FN	VCC = 4.5V, VIL = 3.15V, VIH = 1.35V, (Note 2)	+25°C	-	-	-
Propagation Delay	TPLH1	VCC = 4.5V, VIH = 4.5V, VIL = 0V	+25°C	2	25	ns
	TPHL1	VCC = 4.5V, VIH = 4.5V, VIL = 0V	+25°C	2	25	ns
	TPZL1 TPZL2	VCC = 4.5V, VIH = 4.5V, VIL = 0V	+25°C	2	30	ns
	TPLZ1 TPLZ2	VCC = 4.5V, VIH = 4.5V, VIL = 0V	+25°C	2	30	ns
	TPZH1 TPZH2	VCC = 4.5V, VIH = 4.5V, VIL = 0V	+25°C	2	24	ns
	TPHZ1 TPHZ2	VCC = 4.5V, VIH = 4.5V, VIL = 0V	+25°C	2	30	ns

**NOTES:**

1. All voltages referenced to device GND.
2. For functional tests,  $V_O \geq 4.0V$  is recognized as a logic "1", and  $V_O \leq 0.5V$  is recognized as a logic "0".

**TABLE 5. BURN-IN AND OPERATING LIFE TEST, DELTA PARAMETERS (+25°C)**

PARAMETER	GROUP B SUBGROUP	DELTA LIMIT
ICC	5	+12µA
IOL/IOH	5	-15% of 0 Hour
IOZ	5	±200nA

## Specifications HCS241MS

**TABLE 6. APPLICABLE SUBGROUPS**

CONFORMANCE GROUPS		METHOD	GROUP A SUBGROUPS	READ AND RECORD
Initial Test (Preburn-In)		100%/5004	1, 7, 9	ICC, IOL/H, IOZL/H
Interim Test I (Postburn-In)		100%/5004	1, 7, 9	ICC, IOL/H, IOZL/H
Interim Test II (Postburn-In)		100%/5004	1, 7, 9	ICC, IOL/H, IOZL/H
PDA		100%/5004	1, 7, 9, Deltas	
Interim Test III (Postburn-In)		100%/5004	1, 7, 9	ICC, IOL/H, IOZL/H
PDA		100%/5004	1, 7, 9, Deltas	
Final Test		100%/5004	2, 3, 8A, 8B, 10, 11	
Group A (Note 1)		Sample/5005	1, 2, 3, 7, 8A, 8B, 9, 10, 11	
Group B	Subgroup B-5	Sample/5005	1, 2, 3, 7, 8A, 8B, 9, 10, 11, Deltas	Subgroups 1, 2, 3, 9, 10, 11
	Subgroup B-6	Sample/5005	1, 7, 9	
Group D		Sample/5005	1, 7, 9	

NOTE:

1. Alternate Group A testing in accordance with Method 5005 of MIL-STD-883 may be exercised.

**TABLE 7. TOTAL DOSE IRRADIATION**

CONFORMANCE GROUPS	METHOD	TEST		READ AND RECORD	
		PRE RAD	POST RAD	PRE RAD	POST RAD
Group E Subgroup 2	5005	1, 7, 9	Table 4	1, 9	Table 4 (Note 1)

NOTE:

1. Except FN test which will be performed 100% Go/No-Go.

**TABLE 8. STATIC AND DYNAMIC BURN-IN TEST CONNECTIONS**

OPEN	GROUND	1/2 VCC = 3V ± 0.5V	VCC = 6V ± 0.5V	OSCILLATOR	
				50kHz	25kHz
STATIC BURN-IN I TEST CONDITIONS (Note 1)					
3, 5, 7, 9, 12, 14, 16, 18	1, 2, 4, 6, 8, 10, 11, 13, 15, 17, 19	-	20	-	-
STATIC BURN-IN II TEST CONNECTIONS (Note 1)					
3, 5, 7, 9, 12, 14, 16, 18	10	-	1, 2, 4, 6, 8, 11, 13, 15, 17, 19, 20	-	-
DYNAMIC BURN-IN TEST CONNECTIONS (Note 1)					
-	1, 10	3, 5, 7, 9, 12, 14, 16, 18	19, 20	2, 4, 6, 8, 11, 13, 15, 17	-

NOTES:

1. Each pin except VCC and GND will have a series resistor of 10KΩ ± 5%.
2. Each pin except VCC and GND will have a series resistor of 680Ω ± 5%

**TABLE 9. IRRADIATION TEST CONNECTIONS**

OPEN	GROUND	VCC = 5V ± 0.5V
3, 5, 7, 9, 12, 14, 16, 18	10	1, 2, 4, 6, 8, 11, 13, 15, 17, 19, 20

NOTE: Each pin except VCC and GND will have a series resistor of 47KΩ ± 5%. Group E, Subgroup 2, sample size is 4 dice/wafer, 0 failures.

## HCS241MS

### **Harris Space Level Product Flow - 'MS'**

Wafer Lot Acceptance (All Lots) Method 5007 (Includes SEM)	100% Interim Electrical Test 1 (T1) 100% Delta Calculation (T0-T1)
GAMMA Radiation Verification (Each Wafer) Method 1019, 4 Samples/Wafer, 0 Rejects	100% Static Burn-In 2, Condition A or B, 24 hrs. min., +125°C min., Method 1015
100% Nondestructive Bond Pull, Method 2023	100% Interim Electrical Test 2 (T2)
Sample - Wire Bond Pull Monitor, Method 2011	100% Delta Calculation (T0-T2)
Sample - Die Shear Monitor, Method 2019 or 2027	100% PDA 1, Method 5004 (Notes 1 and 2)
100% Internal Visual Inspection, Method 2010, Condition A	100% Dynamic Burn-In, Condition D, 240 hrs., +125°C or Equivalent, Method 1015
100% Temperature Cycle, Method 1010, Condition C, 10 Cycles	100% Interim Electrical Test 3 (T3)
100% Constant Acceleration, Method 2001, Condition per Method 5004	100% Delta Calculation (T0-T3)
100% PIND, Method 2020, Condition A	100% PDA 2, Method 5004 (Note 2)
100% External Visual	100% Final Electrical Test
100% Serialization	100% Fine/Gross Leak, Method 1014
100% Initial Electrical Test (T0)	100% Radiographic, Method 2012 (Note 3)
100% Static Burn-In 1, Condition A or B, 24 hrs. min., +125°C min., Method 1015	100% External Visual, Method 2009 Sample - Group A, Method 5005 (Note 4) 100% Data Package Generation (Note 5)

#### NOTES:

1. Failures from Interim electrical test 1 and 2 are combined for determining PDA 1.
2. Failures from subgroup 1, 7, 9 and deltas are used for calculating PDA. The maximum allowable PDA = 5% with no more than 3% of the failures from subgroup 7.
3. Radiographic (X-Ray) inspection may be performed at any point after serialization as allowed by Method 5004.
4. Alternate Group A testing may be performed as allowed by MIL-STD-883, Method 5005.
5. Data Package Contents:
  - Cover Sheet (Harris Name and/or Logo, P.O. Number, Customer Part Number, Lot Date Code, Harris Part Number, Lot Number, Quantity).
  - Wafer Lot Acceptance Report (Method 5007). Includes reproductions of SEM photos with percent of step coverage.
  - GAMMA Radiation Report. Contains Cover page, disposition, Rad Dose, Lot Number, Test Package used, Specification Numbers, Test equipment, etc. Radiation Read and Record data on file at Harris.
  - X-Ray report and film. Includes penetrometer measurements.
  - Screening, Electrical, and Group A attributes (Screening attributes begin after package seal).
  - Lot Serial Number Sheet (Good units serial number and lot number).
  - Variables Data (All Delta operations). Data is identified by serial number. Data header includes lot number and date of test.
  - The Certificate of Conformance is a part of the shipping invoice and is not part of the Data Book. The Certificate of Conformance is signed by an authorized Quality Representative.

**Propagation Delay Timing Diagram and Load Circuit**

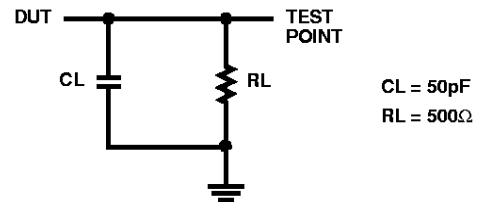
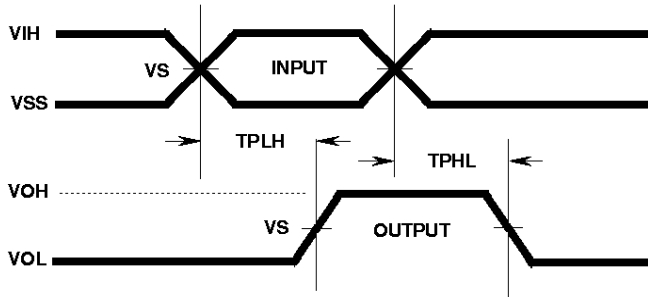

AC VOLTAGE LEVELS

PARAMETER	ACTS	UNITS
VCC	4.50	V
VIH	4.50	V
VIL	0.0	V
VS	2.25	V
GND	0.00	V

**Three-State High Timing Diagram and Load Circuit**

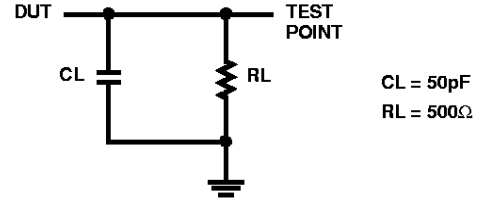
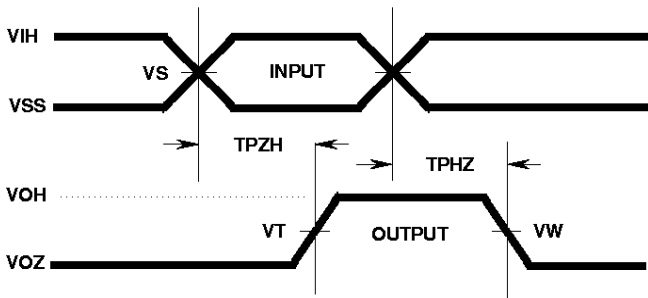

THREE-STATE HIGH VOLTAGE LEVELS

PARAMETER	ACTS	UNITS
VCC	4.50	V
VIH	4.50	V
VS	2.25	V
VT	2.25	V
VW	3.60	V
GND	0.00	V

**Three-State Low Timing Diagram and Load Circuit**

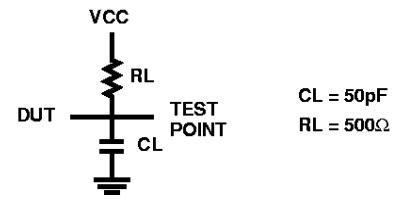
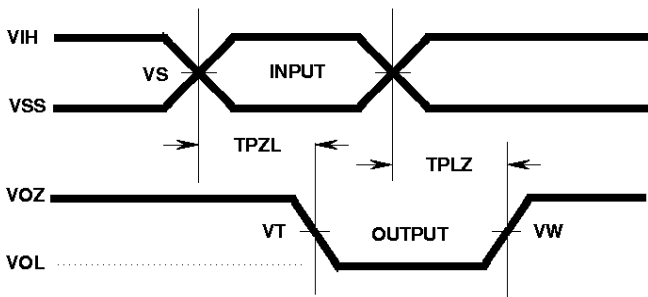

THREE-STATE LOW VOLTAGE LEVELS

	1	8	UNITS
VCC		4.50	V
VIH		4.50	V
VS		2.25	V
VT		2.25	V
VW		0.90	V
GND		0.00	V



# HCS241MS

## Die Characteristics

### DIE DIMENSIONS:

108 x 106 mils

### METALLIZATION:

Type: AlSi

Metal Thickness:  $11\text{k}\text{\AA} \pm 1\text{k}\text{\AA}$

### GLASSIVATION:

Type:  $\text{SiO}_2$

Thickness:  $13\text{k}\text{\AA} \pm 2.6\text{k}\text{\AA}$

### WORST CASE CURRENT DENSITY:

$< 2.0 \times 10^5 \text{A/cm}^2$

### BOND PAD SIZE:

$100\mu\text{m} \times 100\mu\text{m}$

4 mils x 4 mils

## Metallization Mask Layout

