

CABLE SPECIFICATIONS

DESCRIPTION	COLOR CODE	NOMINAL O.D.	OVERALL RATING	COLOR	APPROVAL
3x1.0mm ² H05VV-F	INT'L	7.1	10A 250V	BLACK	

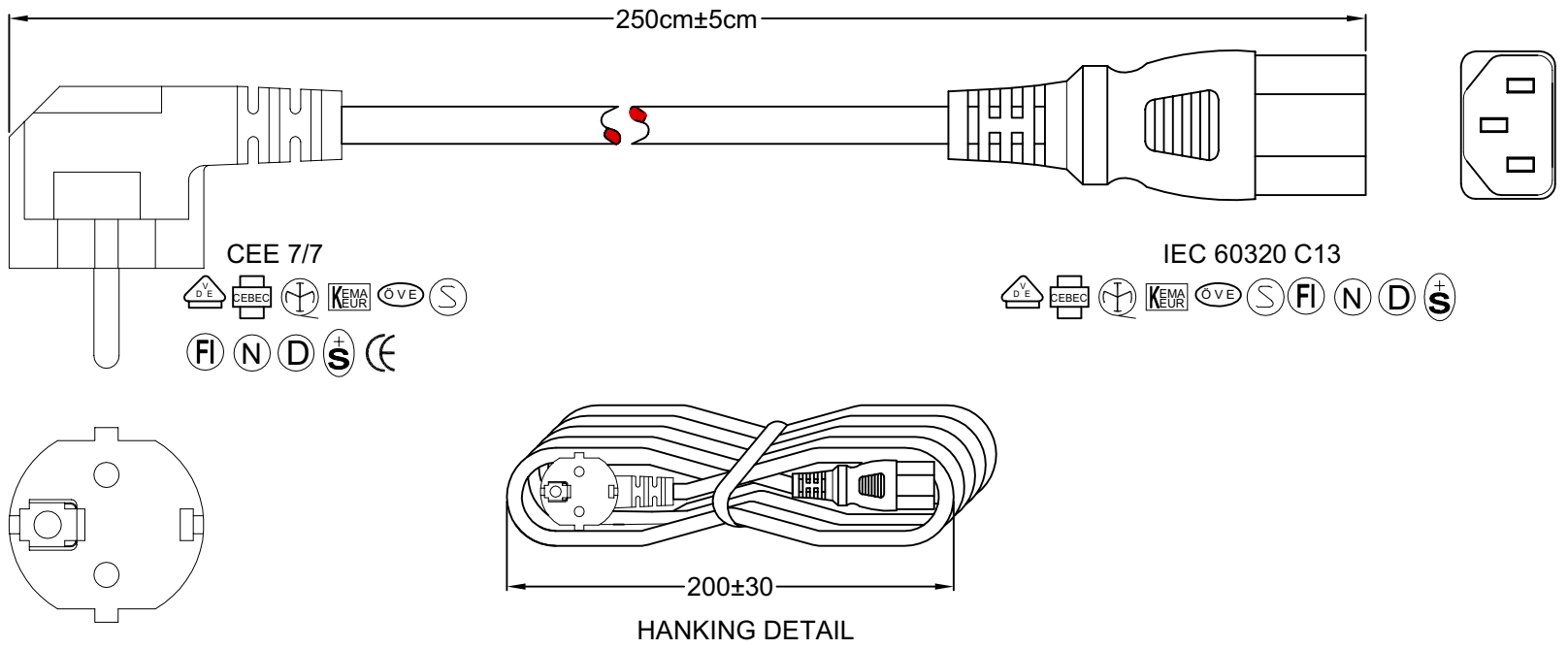

REV	DATE	CHANGE	CHNG CHKD APPR			
			SS	AH	SS	SS
B	3/1/95	REMOVE UTE APRV.	SS	AH	SS	SS
C	3/14/00	UPDATED DRAWING	PB	JJ	SS	TD
D	5/18/00	ADDED HANK SPEC	SS	PB	PB	TD
E	12/10/01	REVISED / UPDATED	GQ	PB	PB	TD

TOLERANCE IN MM UNLESS OTHERWISE SPECIFIED > 1000 ± 50 ≤ 1000 ± 30 STRIPPED LENGTH ± 2		Power Dynamics, Inc. Phone: 973-560-0019 Whippany, New Jersey Fax: 973-560-0076	
DRAWN BY: TM CHECK BY: AH APPR BY: SS		DATE: 1/10/94 DATE: 8/27/98 DATE: 8/27/98	
PART #: 12013		SHEET 1 of 1	
SIZE: A SCALE: NTS		ALL DIMENSIONS FOR REFERENCE ONLY DIMENSIONS ARE IN MILLIMETERS	

D

C

B

A

6

5

4

3

2

1

CABLE SPECIFICATIONS

DESCRIPTION	COLOR CODE	NOMINAL O.D.	OVERALL RATING	COLOR	APPROVAL
3x1.5mm ² H05VV-F3G1.5	CEE	8.3	16A 250V	BLACK	

NOTES:
Packaging specifications: Bulk packed

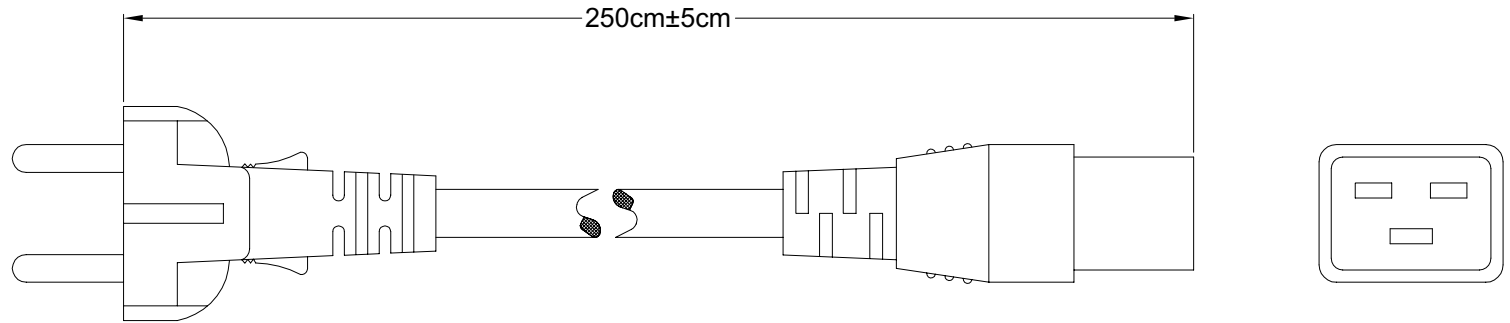

CEE 7/7











IEC 60320 C19

REV	DATE	CHANGE	CHNG CHKD APPR			
			PB	TD	SS	
A	2/25/00	CHNG TO 16A & UPDATED DWG	PB	TD	SS	
B	4/26/00	ADDED PACKAGING SPEC	PB	TD	JJ	
C	5/4/01	UPDATED APPROVALS	PB	TD		
D	12/10/01	REVISED / UPDATED	GQ	PB		

<p>TOLERANCE IN MM UNLESS OTHERWISE SPECIFIED > 1000 ± 50 <= 1000 ± 30 STRIPPED LENGTH ± 2</p>		<p>Power Dynamics, Inc. Phone: 973-560-0019 Whippany, New Jersey Fax: 973-560-0076</p>	
<p>DRAWN BY: SLS DATE: 2/15/95</p>		<p>PART: CONTINENTAL EUROPE CORD SET CEE 7/7 STRAIGHT TO IEC 60320 C19</p>	
<p>CHECK BY: AH DATE: 12/10/98</p>		<p>12060</p>	
<p>APPR BY: SS DATE: 12/10/96</p>		<p>PART #: 12060</p>	
<p>SCALE: NTS</p>		<p>ALL DIMENSIONS FOR REFERENCE ONLY DIMENSIONS ARE IN MILLIMETERS</p>	
		<p>SHEET 1 of 1 REV: D</p>	

CABLE SPECIFICATIONS

DESCRIPTION	COLOR CODE	NOMINAL O.D.	OVERALL RATING	COLOR	APPROVAL
3x1.0mm ² H05VV-F	INT'L	7.1	10A 250V	BLACK	        

NOTES:
Packaging specifications: Bulk packed

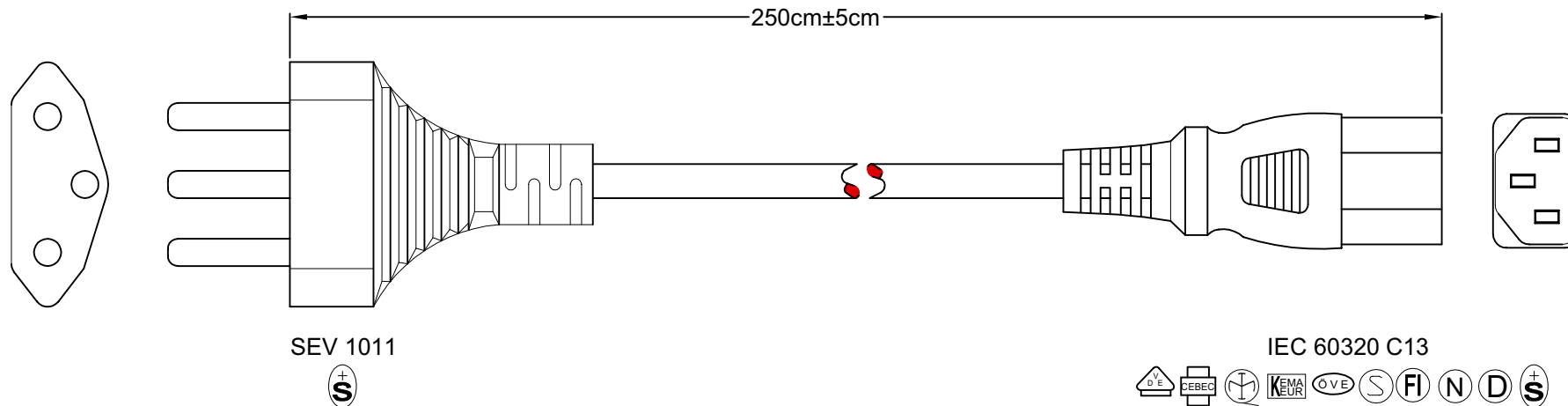

REV	DATE	CHANGE	CHNG CHKD			APPR		
			TD	JJ	PB	TD	PB	PB
A	10/2/00	ADD PACKAGING SPEC						
B	1/18/00	UPDATED APPROVALS	SS	TD	PB			
C	12/10/01	REVISED / UPDATED	GQ		PB			

TOLERANCE IN MM UNLESS OTHERWISE SPECIFIED > 1000 ± 50 ≤ 1000 ± 30 STRIPPED LENGTH ± 2		Power Dynamics, Inc. Phone: 973-560-0019 Whippany, New Jersey Fax: 973-560-0076	
DRAWN BY: SLS CHECK BY: AH APPR BY: LH		DATE: 10/13/98 DATE: 10/16/98 DATE: 10/16/98	
PART #: 13012		SHEET 1 of 1	
SIZE: A SCALE: NTS		ALL DIMENSIONS FOR REFERENCE ONLY DIMENSIONS ARE IN MILLIMETERS	
		REV: C	

D

C

B

A

6

5

4

3

2

1

CABLE SPECIFICATIONS

DESCRIPTION	COLOR CODE	NOMINAL O.D.	OVERALL RATING	COLOR	APPROVAL
3x1.0mm ² H05VV-F	INT'L	7.1	10A 250V	BLACK	

NOTES:

1. Cord set is supplied with a 13A fuse

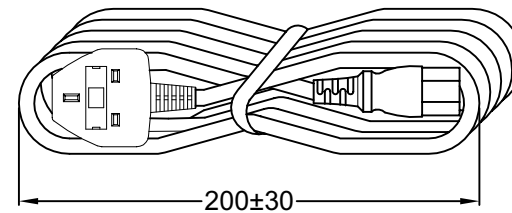
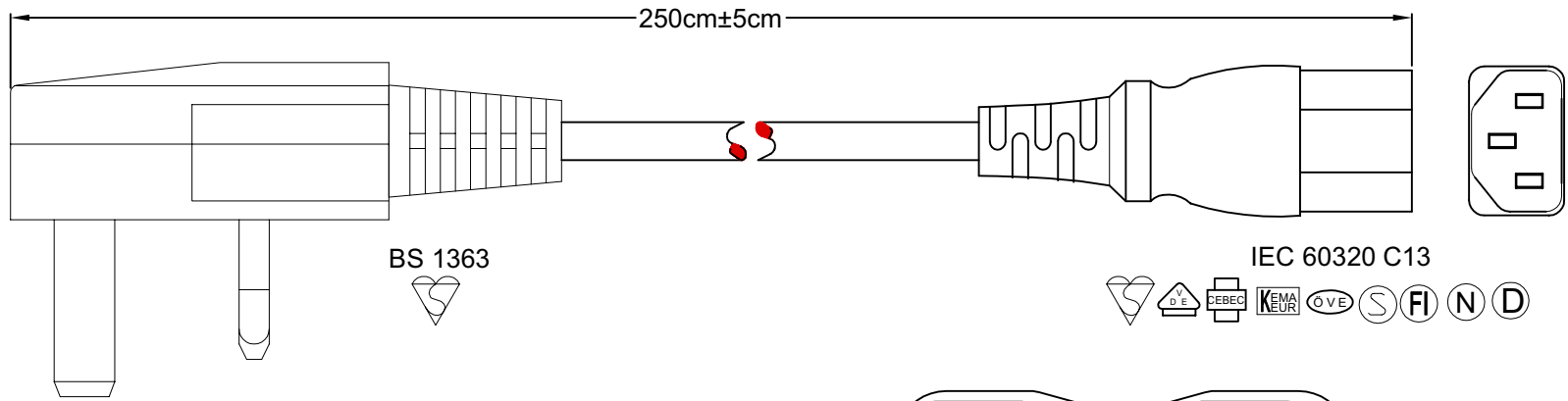

HANKING DETAIL

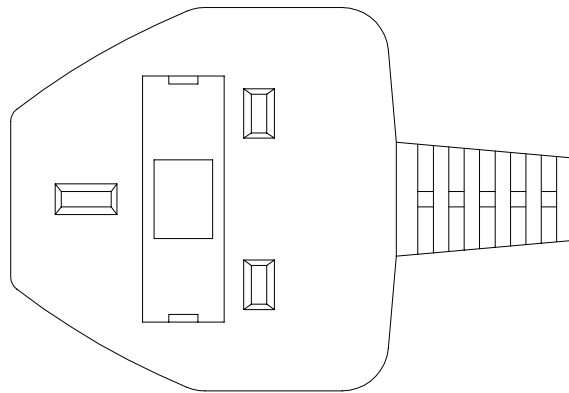

REV	DATE	CHANGE	CHNG		CHKD		APPR	
			SS	TD	SS	TD	PJ	SS
A	4/99	CHANGED PLUG	PB	TD	SS	TD	JJ	SS
B	3/14/00	UPDATED DRAWING	PB	TD	PB	TD	JJ	SS
C	4/20/00	ADDED PACKING SPEC.	PB	TD	JJ	TD	JJ	SS
D	5/25/00	ADD HANKING SPEC.	PB	TD	PB	TD	JJ	SS
E	11/14/00	UPDATED APPROVALS	PB	TD	PB	TD	JJ	SS
F	12/10/01	REVISED / UPDATED	GQ	PB				

TOLERANCE IN MM UNLESS OTHERWISE SPECIFIED > 1000 ± 50 ≤ 1000 ± 30 STRIPPED LENGTH ± 2		Power Dynamics, Inc. Phone: 973-560-0019 Whippany, New Jersey Fax: 973-560-0076	
DRAWN BY: AH CHECK BY: TD APPR BY: PJ		DATE: 8/25/98 DATE: 4/20/99 DATE: 4/20/99	
PART #: 14012		SHEET 1 of 1	
SIZE: A SCALE: NTS		ALL DIMENSIONS FOR REFERENCE ONLY DIMENSIONS ARE IN MILLIMETERS	

D

C

B

A

0

5

4

3

2

1

6

5

4

3

2

1

6

5

4

3

2

1

CABLE SPECIFICATIONS

DESCRIPTION	COLOR CODE	-	OVERALL RATING	COLOR	APPROVAL
3x1.0mm ² H05VV-F	INT'L	-	10A 250V	BLACK	

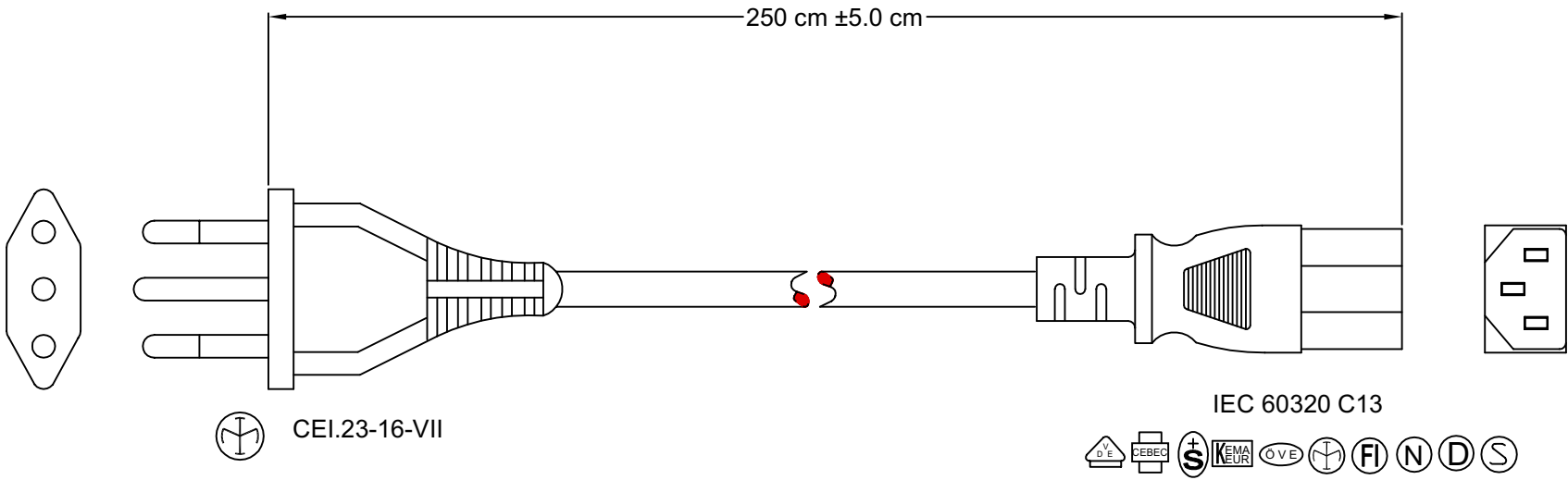

REV	DATE	CHANGE	CHNG		CHKD		APPR	
			TD	PB	TD	PB	TD	PB
A	4/17/00	REVISED & UPDATE			JJ	JJ		
B	11/14/00	UPDATE APPROVALS			PB	TD		JJ

PACKAGING SPECIFICATIONS:
Bulk packed

TOLERANCE IN MM UNLESS OTHERWISE SPECIFIED		
> 1000	±	50
<= 1000	±	30
STRIPPED LENGTH ± 2		

DRAWN BY	SLS	DATE:	10/13/98
CHECK BY		DATE:	
APPR BY	SLS	DATE:	9/8/98

Power Dynamics, Inc.
Phone: 973-560-0019 Whippany, New Jersey Fax: 973-560-0076

PART: ITALIAN CORD SET, CEI.23-16-VII PLUG TO IEC 60320 C13 RECEPTACLE

14512

SCALE: NTS

ALL DIMENSIONS FOR REFERENCE ONLY
DIMENSIONS ARE IN MILLIMETERS

SHEET 1 of 1
REV: B

6

5

4

3

2

1

CABLE SPECIFICATIONS

DESCRIPTION	COLOR CODE	NOMINAL O.D.	OVERALL RATING	COLOR	APPROVAL
3x1.0mm ² H05VV-F	INT'L	7.1	10A 250V	BLACK	

NOTES:
Packaging specifications: Bulk packed

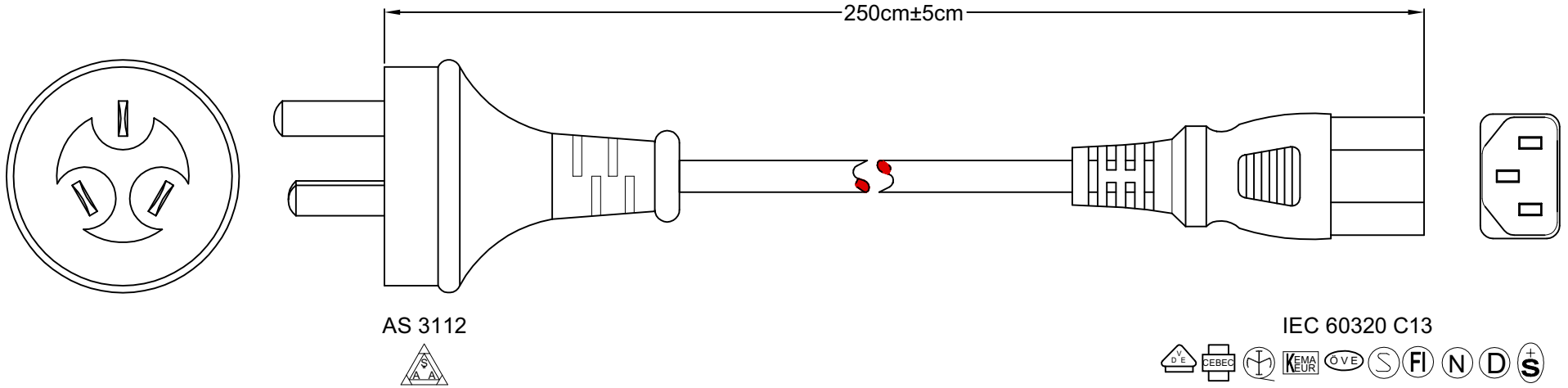

REV	DATE	CHANGE	CHNG			CHKD			APPR			
			TD	PB	SS	TD	SS	PB	SS	TD	JJ	
A	02/00	UPDATE DWG										
B	4/20/00	ADDED PACKING SPEC.										
C	5/1/01	ADDED APPROVALS SYMB.										
D	12/10/01	REVISED / UPDATED										

TOLERANCE IN MM UNLESS OTHERWISE SPECIFIED > 1000 ± 50 ≤ 1000 ± 30 STRIPPED LENGTH ± 2		Power Dynamics, Inc. Phone: 973-560-0019 Whippany, New Jersey Fax: 973-560-0076	
DRAWN BY: SS CHECK BY: LH APPR BY: AH		DATE: 10/13/98 DATE: 10/13/98 DATE: 10/13/98	
PART #: 15012		SHEET 1 of 1	
SIZE: A SCALE: NTS		ALL DIMENSIONS FOR REFERENCE ONLY DIMENSIONS ARE IN MILLIMETERS	
REV: D			

D

C

B

A

6

5

4

3

2

1

CABLE SPECIFICATIONS

DESCRIPTION	COLOR CODE	NOMINAL O.D.	OVERALL RATING	COLOR	APPROVAL
3x1.0mm ² H05VV-F	INT'L	7.1	5A 250V	BLACK	

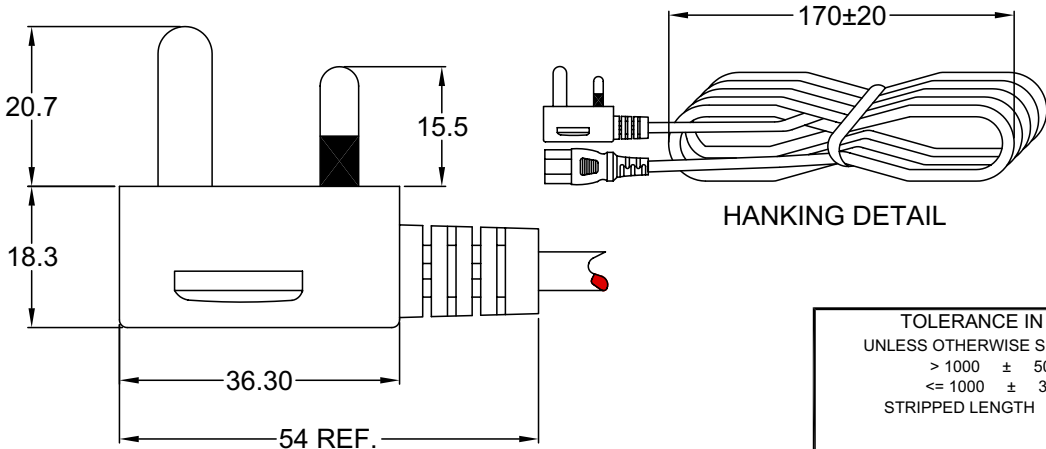
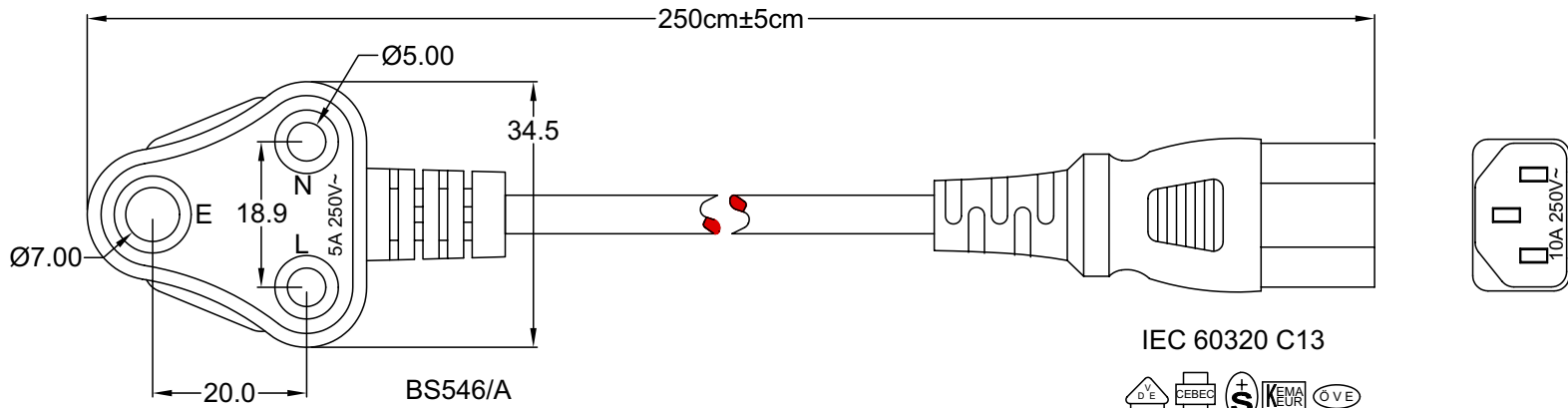

REV	DATE	CHANGE	CHNG		CHKD		APPR	
			PB	TD	PB	TD	PB	TD
A	4/20/00	REVISED / REDRAWN	PB	TD	PB	TD	PB	PB
B	10/17/01	REVISED & UPDATED	TD	PB	PB	PB	PB	PB
C	10/28/01	ADD PLUG 7 CON.-DIM	TD	PB	PB	PB	PB	PB
D	12/11/01	REVISED / UPDATED	GQ	PB	PB	PB	PB	PB
E	4/08/02	O. RATING WAS 10A	TD	PB	PB	PB	PB	PB

TOLERANCE IN MM
UNLESS OTHERWISE SPECIFIED
> 1000 ± 50
<= 1000 ± 30
STRIPPED LENGTH ± 2

Power Dynamics, Inc.
Phone: 973-560-0019 Whippany, New Jersey Fax: 973-560-0076

PART: INDIA / SOUTH AFRICA CORD SET;
250cm LONG; BS546/A TO IEC 60320 C13

DRAWN BY: TD DATE: 4/30/99
CHECK BY: PJ DATE: 4/30/99
APPR BY: SS DATE: 4/30/99

PART #: 16012
SIZE: A
SCALE: NTS

SHEET 1 of 1
REV: E

ALL DIMENSIONS FOR REFERENCE ONLY
DIMENSIONS ARE IN MILLIMETERS

CABLE SPECIFICATIONS

DESCRIPTION	COLOR CODE	NOMINAL O.D.	OVERALL RATING	COLOR	APPROVAL
3x1.0mm ² H05VV-F	INT'L	7.1	10A 250V	BLACK	

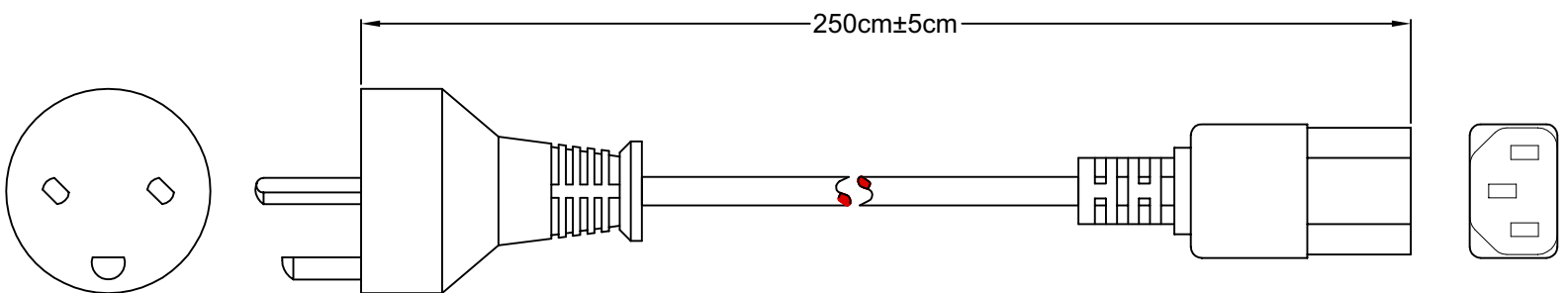

SRAF
Ⓚ

IEC 60320 C13

REV	DATE	CHANGE	CHNG CHKD APPR		
			PB	TD	JJ
A	11/14/00	UPDATED DRAWING	PB	TD	JJ
B	5/1/01	ADDED LENGTH DIM.	PB	TD	
C	12/10/01	REVISED / UPDATED	GQ	PB	

TOLERANCE IN MM UNLESS OTHERWISE SPECIFIED > 1000 ± 50 ≤ 1000 ± 30 STRIPPED LENGTH ± 2		Power Dynamics, Inc. Phone: 973-560-0019 Whippany, New Jersey Fax: 973-560-0076	
DRAWN BY TD DATE: 4/30/99 CHECK BY PJ DATE: 4/30/99 APPR BY SS DATE: 4/30/99		PART: DENMARK CORD SET; 250cm LONG SRAF TO IEC 60320 C13	
PART #: 18012		SHEET 1 of 1	
SIZE: A SCALE: NTS		ALL DIMENSIONS FOR REFERENCE ONLY DIMENSIONS ARE IN MILLIMETERS	
		REV: C	

D

C

B

A

6

5

4

3

2

1

6

5

4

3

2

1

CABLE SPECIFICATIONS

DESCRIPTION	COLOR CODE	-	OVERALL RATING	COLOR	APPROVAL
3x0.75mm ² VCTF	INT'L	-	7A 125V	BLACK	

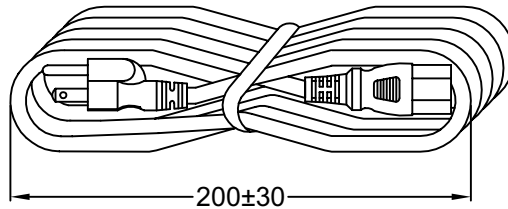
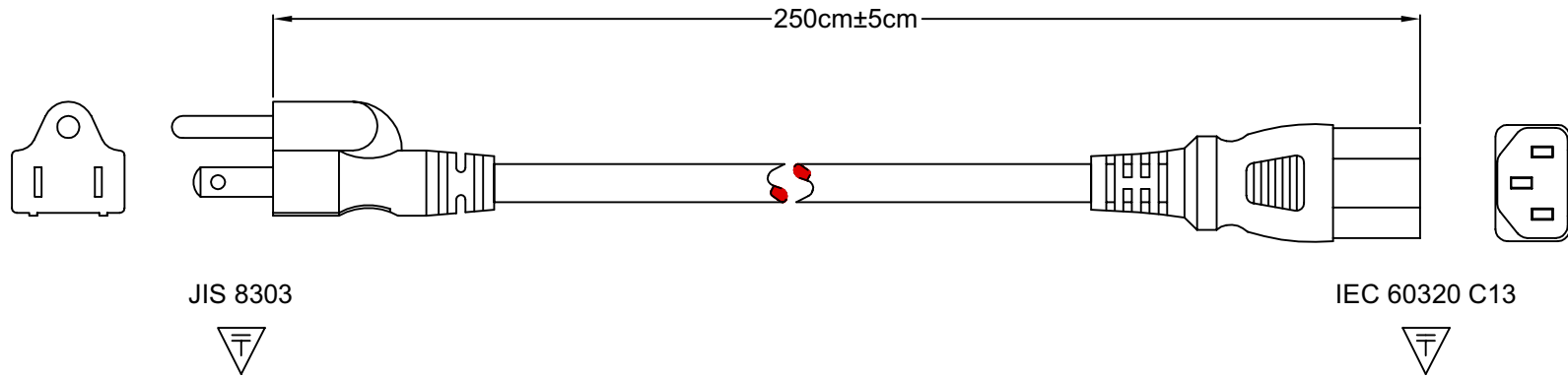

HANKING DETAIL

REV	DATE	CHNG		CHKD		APPR	
		CHANGE	UPDATED / DRAWING	PB	TD	JJ	JJ
A	11/14/00						
B	12/13/01						

TOLERANCE IN MM UNLESS OTHERWISE SPECIFIED > 1000 ± 50 ≤ 1000 ± 30 STRIPPED LENGTH ± 2		Power Dynamics, Inc. Phone: 973-560-0019 Whippany, New Jersey Fax: 973-560-0076	
DRAWN BY TD DATE: 4/30/99 CHECK BY SS DATE: 4/30/99 APPR BY JJ DATE: 4/30/99		PART: JAPAN CORD SET; 250cm LONG JIS 8303 TO IEC 60320 C13	
PART #: 19012		SHEET 1 of 1	
SIZE: A SCALE: NTS		ALL DIMENSIONS FOR REFERENCE ONLY DIMENSIONS ARE IN MILLIMETERS	
		REV: B	