

T-1^{3/4} Super Ultra-Bright LED Lamps

Technical Data

HLMP-8115 **HLMP-8109**
HLMP-8205 **HLMP-8209**
HLMP-8305 **HLMP-8309**
HLMP-8405 **HLMP-8409**
HLMP-8505 **HLMP-8509**
HLMP-8605

Features

- **Very High Intensity**
- **Narrow and Medium Viewing Angles**
- **Untinted, Nondiffused Lens**
- **Choice of Five Colors**
- **Sturdy Leads with Seating Plane Tabs**

Description

These untinted, nondiffused solid state lamps are designed with special internal optics to give a very high luminous intensity within a well defined viewing angle. The LED materials used within these devices is specifically grown to assure the high light output performance these lamps provide.

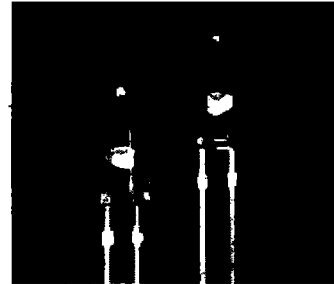

Device Selection Guide

LED Color	Part Number	Typical Luminous Intensity (mcd @ 20 mA dc)	2θ ^{1/2} Viewing Angle
DH AS AlGaAs	HLMP-8115	1000	10°
	HLMP-8109	500	20°
High Efficiency Red	HLMP-8205	350	10°
	HLMP-8209	260	20°
Yellow	HLMP-8305	350	10°
	HLMP-8309	260	20°
Orange	HLMP-8405	350	10°
	HLMP-8409	260	20°
High Performance Green	HLMP-8505	400	10°
	HLMP-8509	300	20°
Emerald Green	HLMP-8605	75	10°

Package Dimensions

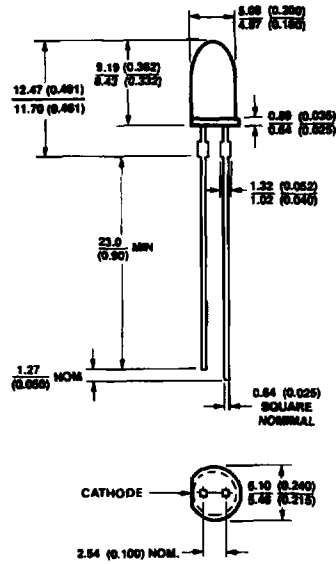
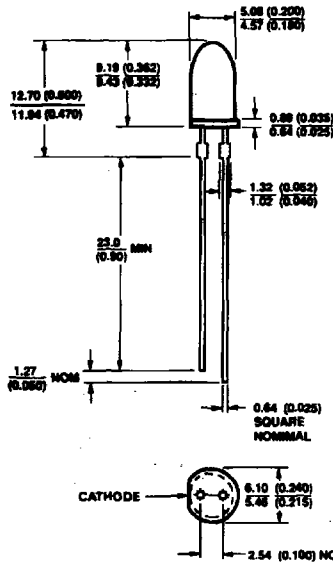

- NOTES:
1. ALL DIMENSIONS ARE IN MILLIMETRES (INCHES).
 2. THE LEADS ARE MILD STEEL, SOLDER DIPPED.
 3. AN EPOXY MENISCUS MAY EXTEND ABOUT 1 mm (0.040") DOWN THE LEADS.

Absolute Maximum Ratings at $T_A = 25^\circ\text{C}$

Parameter	DH AS AlGaAs Red	High Efficiency Red and Orange	Yellow	High Performance Green/Emerald Green	Units
DC Forward Current ^[1]	30	30	20	30	mA
Peak Forward Current ^[2]	300	90	60	90	mA
Average Forward Current ^[2]	20	25	20	25	mA
Transient Forward Current ^[3] (10 μs Pulse)	500	500	500	500	mA
Reverse Voltage ($I_R = 100 \mu\text{A}$)	5	5	5	5	V
LED Junction Temperature	110	110	110	110	$^\circ\text{C}$
Operating Temperature Range	-20 to +100	-55 to +100		-20 to +100	$^\circ\text{C}$
Storage Temperature Range	-55 to +100				$^\circ\text{C}$
Lead Soldering Temperature [1.6 mm (0.063 in.) from body]	260 $^\circ\text{C}$ for 5 seconds				

Notes:

1. See Figure 5 for maximum current derating vs. ambient temperature.
2. See Figure 6 for maximum peak current vs. pulse duration and allowable duty factor.
3. The transient peak current is the maximum non-recurring peak current the device can withstand without damaging the LED die and wire bond. Do not operate these lamps at peak currents above the Absolute Maximum Peak Forward Current.

Electrical/Optical Characteristics $T_A = 25^\circ\text{C}$

DH AS AlGaAs HLMP-8115/8109

Parameter	Symbol	Min.	Typ.	Max.	Units	Test Conditions
Luminous Intensity HLMP-8115 HLMP-8109	I_v	500 200	1000 500		mcd	$I_F = 20 \text{ mA}$
Forward Voltage	V_F		1.8	2.2	V	$I_F = 20 \text{ mA}$
Reverse Breakdown Voltage	V_R	5.0	15.0		V	$I_R = 100 \mu\text{A}$
Included Angle Between Half Intensity Points HLMP-8115 HLMP-8109	$2\theta_{1/2}$		10 20		Deg.	
Total Luminous Flux	ϕ_d		120		mlm	$I_F = 20 \text{ mA}$
Peak Wavelength	λ_{PEAK}		645		nm	Measured at Peak
Dominant Wavelength ^[1]	λ_d		637		nm	
Spectral Line Half Width	$\Delta\lambda_{1/2}$		20		nm	
Speed of Response	τ_s		30		ns	Time Constant, e^{-t/τ_s}
Capacitance	C		30		pF	$V_F = 0, f = 1 \text{ MHz}$
Thermal Resistance	$R\theta_{J-\text{LEAD}}$		210		$^\circ\text{C/W}$	LED Junction-to-Cathode Lead
Luminous Efficacy ^[2]	η_v		80		lm/W	

High Efficiency Red HLMP-8205/8209

Parameter	Symbol	Min.	Typ.	Max.	Units	Test Conditions
Luminous Intensity HLMP-8205 HLMP-8209	I_v	200 90	350 260		mcd	$I_F = 20 \text{ mA}$
Forward Voltage	V_F		1.9	2.6	V	$I_F = 20 \text{ mA}$
Reverse Breakdown Voltage	V_R	5.0	30.0		V	$I_R = 100 \mu\text{A}$
Included Angle Between Half Intensity Points HLMP-8205 HLMP-8209	$2\theta_{1/2}$		10 20		Deg.	
Total Luminous Flux	ϕ_v		45		mlm	$I_F = 20 \text{ mA}$
Peak Wavelength	λ_{PEAK}		635		nm	Measured at Peak
Dominant Wavelength ^[1]	λ_d		626		nm	
Spectral Line Half Width	$\Delta\lambda_{1/2}$		40		nm	
Speed of Response	τ_s		90		ns	
Capacitance	C		11		pF	$V_F = 0, f = 1 \text{ MHz}$
Thermal Resistance	$R\theta_{J-\text{LEAD}}$		210		$^\circ\text{C/W}$	LED Junction-to-Cathode Lead
Luminous Efficacy ^[2]	η_v		145		lm/W	

Yellow HLMP-8305/8309

Parameter	Symbol	Min.	Typ.	Max.	Units	Test Conditions
Luminous Intensity HLMP-8305 HLMP-8309	I_v	212 96	350 260		mcd	$I_F = 20 \text{ mA}$
Forward Voltage	V_F		2.1	2.6	V	$I_F = 20 \text{ mA}$
Reverse Breakdown Voltage	V_R	5.0	30.0		V	$I_R = 100 \mu\text{A}$
Included Angle Between Half Intensity Points HLMP-8305 HLMP-8309	$2\theta_{1/2}$		10 20		Deg.	
Total Luminous Flux	ϕ_v		45		mlm	$I_F = 20 \text{ mA}$
Peak Wavelength	λ_{PEAK}		583		nm	Measured at Peak
Dominant Wavelength ^[1]	λ_d		585		nm	
Spectral Line Half Width	$\Delta\lambda_{1/2}$		36		nm	
Speed of Response	τ_s		90		ns	
Capacitance	C		15		pF	$V_F = 0, f = 1 \text{ MHz}$
Thermal Resistance	$R\theta_{\text{J-LEAD}}$		210		°C/W	LED Junction-to-Cathode Lead
Luminous Efficacy ^[2]	η_v		500		lm/W	

Orange HLMP-8405/8409

Parameter	Symbol	Min.	Typ.	Max.	Units	Test Conditions
Luminous Intensity HLMP-8405 HLMP-8409	I_v	200 90	350 260		mcd	$I_F = 20 \text{ mA}$
Forward Voltage	V_F		1.9	2.6	V	$I_F = 20 \text{ mA}$
Reverse Breakdown Voltage	V_R	5.0	30.0		V	$I_R = 100 \mu\text{A}$
Included Angle Between Half Intensity Points HLMP-8405 HLMP-8409	$2\theta_{1/2}$		10 20		Deg.	
Total Luminous Flux	ϕ_v		45		mlm	$I_F = 20 \text{ mA}$
Peak Wavelength	λ_{PEAK}		600		nm	Measured at Peak
Dominant Wavelength ^[1]	λ_d		602		nm	
Spectral Line Half Width	$\Delta\lambda_{1/2}$		40		nm	
Speed of Response	τ_s		280		ns	
Capacitance	C		4		pF	$V_F = 0, f = 1 \text{ MHz}$
Thermal Resistance	$R\theta_{\text{J-LEAD}}$		210		°C/W	LED Junction-to-Cathode Lead
Luminous Efficacy ^[2]	η_v		380		lm/W	

High Performance Green HLMP-8505/8509

Parameter	Symbol	Min.	Typ.	Max.	Units	Test Conditions
Luminous Intensity HLMP-8505 HLMP-8509	I_v	170 111	400 300		mcd	$I_F = 20 \text{ mA}$
Forward Voltage	V_F		2.2	3.0	V	$I_F = 20 \text{ mA}$
Reverse Breakdown Voltage	V_R	5.0	30		V	$I_R = 100 \mu\text{A}$
Included Angle Between Half Intensity Points						
HLMP-8505 HLMP-8509	$2\theta_{1/2}$		10 20		Deg.	
Total Luminous Flux	ϕ_v		115		mlm	$I_F = 20 \text{ mA}$
Peak Wavelength	λ_{PEAK}		568		nm	Measured at Peak
Dominant Wavelength ^[1]	λ_d		570		nm	
Spectral Line Half Width	$\Delta\lambda_{1/2}$		28		nm	
Speed of Response	τ_s		260		ns	
Capacitance	C		18		pF	$V_F = 0, f = 1 \text{ MHz}$
Thermal Resistance	$R\theta_{\text{J-LEAD}}$		210		°C/W	LED Junction-to-Cathode Lead
Luminous Efficacy ^[2]	η_v		595		lm/W	

Notes:

1. The dominant wavelength, λ_d , is derived from the CIE Chromaticity Diagram and represents the color of the device.
2. The radiant intensity, I_e , in watts per steradian, may be found from the equation $I_e = I_v/\eta_v$, where I_v is the luminous intensity in candelas and η_v is the luminous efficacy in lumens/watt.

Emerald Green HLMP-8605^[1]

Parameter	Symbol	Min.	Typ.	Max.	Units	Test Conditions
Luminous Intensity HLMP-8605	I_v	69	75		mcd	$I_F = 20 \text{ mA}$
Forward Voltage	V_F		2.2	3.0	V	$I_F = 20 \text{ mA}$
Reverse Breakdown Voltage	V_R	5.0	30		V	$I_R = 100 \mu\text{A}$
Included Angle Between Half Intensity Points						
HLMP-8605	$2\theta_{1/2}$		10		Deg.	
Peak Wavelength	λ_{PEAK}		558		nm	Measured at Peak
Dominant Wavelength ^[2]	λ_d		560		nm	
Spectral Line Half Width	$\Delta\lambda_{1/2}$		24		nm	
Speed of Response	τ_s		3100		ns	
Capacitance	C		35		pF	$V_F = 0, f = 1 \text{ MHz}$
Thermal Resistance	$R\theta_{\text{J-LEAD}}$		210		°C/W	LED Junction-to-Cathode Lead
Luminous Efficacy ^[3]	η_v		656		lm/W	

Notes:

1. Please refer to Application Note 1061 for information comparing standard green and emerald green light output degradation.
2. The dominant wavelength, λ_d , is derived from the CIE Chromaticity Diagram and represents the color of the device.
3. The radiant intensity, I_e , in watts per steradian, may be found from the equation $I_e = I_v/\eta_v$, where I_v is the luminous intensity in candelas and η_v is the luminous efficacy in lumens/watt.

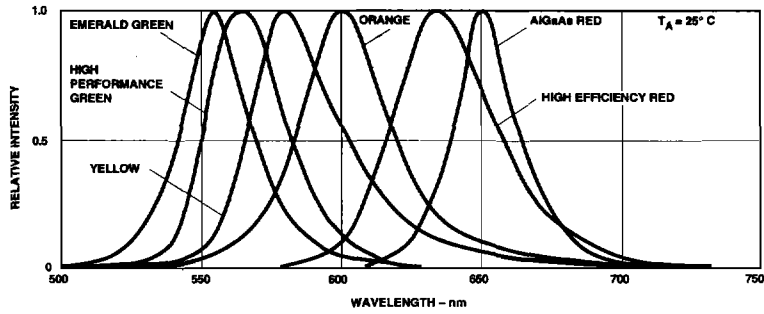

Figure 1. Relative Intensity vs. Wavelength.

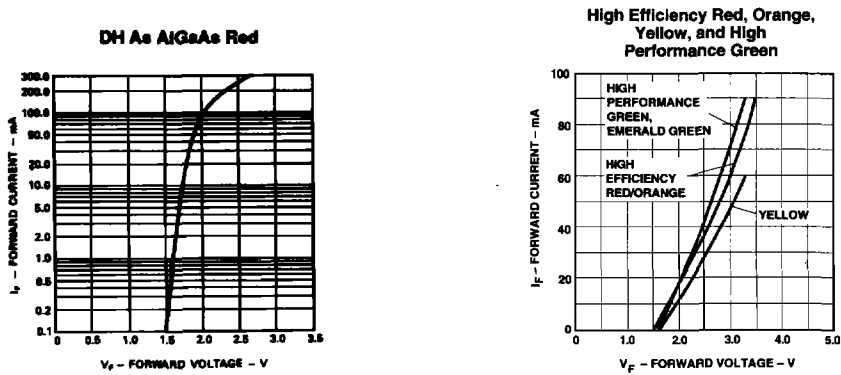

Figure 2. Forward Current vs. Forward Voltage (Non-Resistor Lamp).

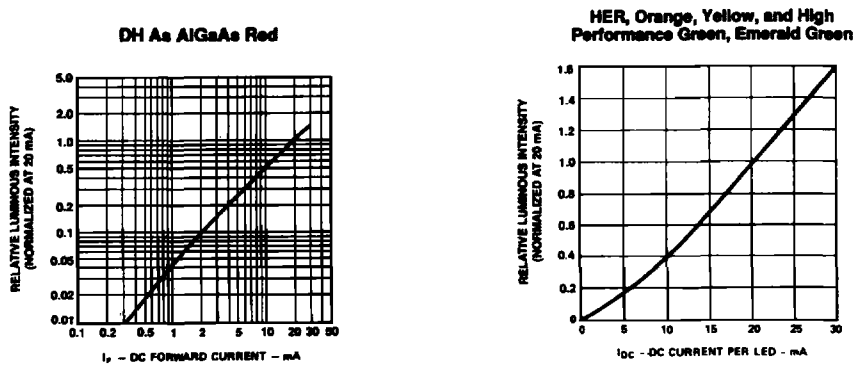

Figure 3. Relative Luminous Intensity vs. Forward Current.

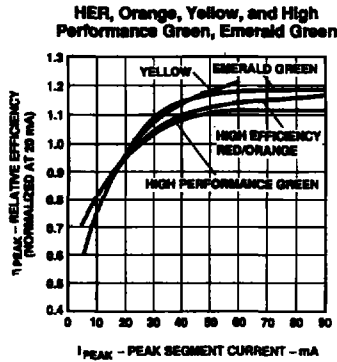
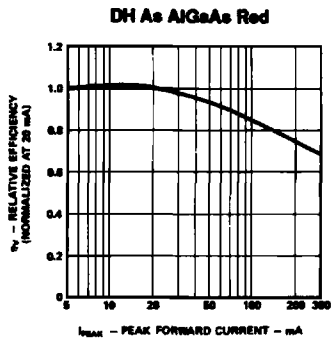

Figure 4. Relative Efficiency (Luminous Intensity per Unit Current) vs. Peak Current.

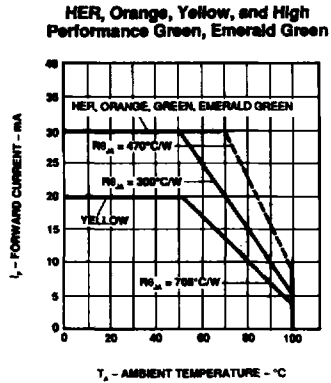
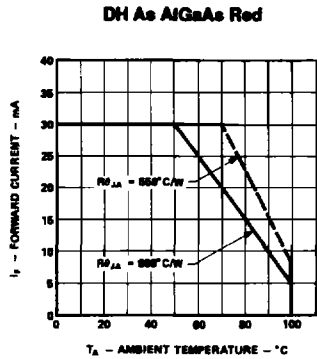

Figure 5. Maximum Forward dc Current vs. Ambient Temperature. Derating Based on T_J MAX = 110 °C.

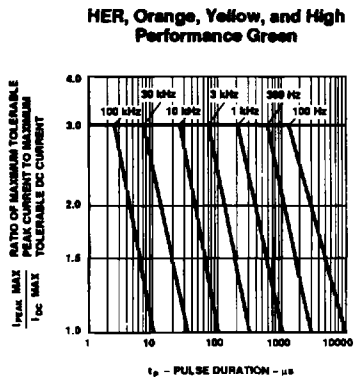
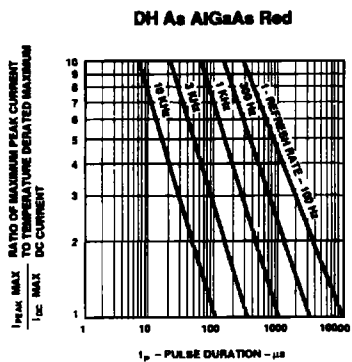

Figure 6. Maximum Tolerable Peak Current vs. Pulse Duration. (I_{DC} MAX as per MAX Ratings).

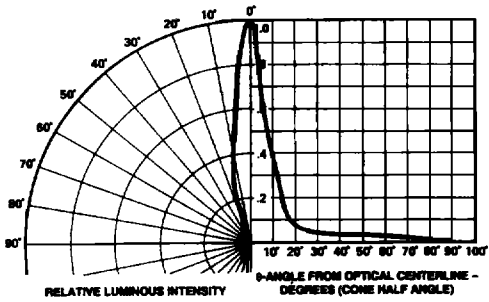

Figure 7. Relative Luminous Intensity vs. Angular Displacement. HLMP-8115/-8X05.

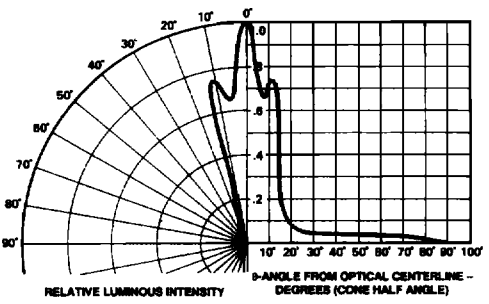

Figure 8. Relative Luminous Intensity vs. Angular Displacement. HLMP-8X09.