

## Inverter Grade Thyristors (Hockey PUK Version), 515 A

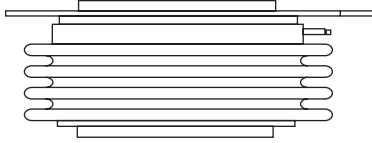

TO-200AC (B-PUK)

**FEATURES**

- Metal case with ceramic insulator
- All diffused design
- Center amplifying gate
- Guaranteed high dV/dt
- Guaranteed high dI/dt
- International standard case TO-200AC (B-PUK)
- High surge current capability
- Low thermal impedance
- High speed performance
- Lead (Pb)-free
- Designed and qualified for industrial level



**RoHS**  
COMPLIANT

**PRODUCT SUMMARY**

$I_{T(AV)}$	515 A
-------------	-------

**TYPICAL APPLICATIONS**

- Inverters
- Choppers
- Induction heating
- All types of force-commutated converters

**MAJOR RATINGS AND CHARACTERISTICS**

PARAMETER	TEST CONDITIONS	VALUES	UNITS
$I_{T(AV)}$		515	A
	$T_{hs}$	55	°C
$I_{T(RMS)}$		995	A
	$T_{hs}$	25	°C
$I_{TSM}$	50 Hz	7950	A
	60 Hz	8320	
$I^2t$	50 Hz	316	kA <sup>2</sup> s
	60 Hz	289	
$V_{DRM}/V_{RRM}$		400 to 1200	V
$t_q$	Range	10 to 30	μs
$T_J$		- 40 to 125	°C

**Note**

- $t_q = 10$  to  $20 \mu s$  for 400 to 800 V devices
- $t_q = 15$  to  $30 \mu s$  for 1000 to 1200 V devices

**ELECTRICAL SPECIFICATIONS**
**VOLTAGE RATINGS**

TYPE NUMBER	VOLTAGE CODE	$V_{DRM}/V_{RRM}$ , MAXIMUM REPETITIVE PEAK VOLTAGE V	$V_{RSM}$ , MAXIMUM NON-REPETITIVE PEAK VOLTAGE V	$I_{DRM}/I_{RRM}$ MAXIMUM AT $T_J = T_J$ MAXIMUM mA
ST303C..L	04	400	500	50
	08	800	900	
	10	1000	1100	
	12	1200	1300	

# ST303CLPbF Series



Vishay High Power Products Inverter Grade Thyristors  
(Hockey PUK Version), 515 A

CURRENT CARRYING CAPABILITY							
FREQUENCY							UNITS
50 Hz	1130	950	1800	1540	5660	4990	A
400 Hz	1010	820	1850	1570	2830	2420	
1000 Hz	680	530	1560	1300	1490	1220	
2500 Hz	230	140	690	510	540	390	
Recovery voltage $V_R$	50		50		50		V
Voltage before turn-on $V_D$	$V_{DRM}$		$V_{DRM}$		$V_{DRM}$		
Rise of on-state current $di/dt$	50		-		-		A/μs
Heatsink temperature	40	55	40	55	40	55	°C
Equivalent values for RC circuit	10/0.47		10/0.47		10/0.47		Ω/μF

ON-STATE CONDUCTION						
PARAMETER	SYMBOL	TEST CONDITIONS			VALUES	UNITS
Maximum average on-state current at heatsink temperature	$I_{T(AV)}$	180° conduction, half sine wave double side (single side) cooled			515 (190)	A
					55 (85)	°C
Maximum RMS on-state current	$I_{T(RMS)}$	DC at 25 °C heatsink temperature double side cooled			995	A
Maximum peak, one half cycle, non-repetitive surge current	$I_{TSM}$	t = 10 ms	No voltage reappplied	Sinusoidal half wave, initial $T_J = T_J$ maximum	7950	
		t = 8.3 ms			8320	
		t = 10 ms	100 % $V_{RRM}$ reappplied		6690	
		t = 8.3 ms			7000	
Maximum $I^2t$ for fusing	$I^2t$	t = 10 ms	No voltage reappplied		316	
		t = 8.3 ms			289	
		t = 10 ms	100 % $V_{RRM}$ reappplied		224	
		t = 8.3 ms			204	
Maximum $I^2\sqrt{t}$ for fusing	$I^2\sqrt{t}$	t = 0.1 to 10 ms, no voltage reappplied			3160	$kA^2\sqrt{s}$
Maximum peak on-state voltage	$V_{TM}$	$I_{TM} = 1255$ A, $T_J = T_J$ maximum, $t_p = 10$ ms sine wave pulse			2.16	V
Low level value of threshold voltage	$V_{T(TO)1}$	$(16.7\% \times \pi \times I_{T(AV)} < I < \pi \times I_{T(AV)})$ , $T_J = T_J$ maximum			1.44	
High level value of threshold voltage	$V_{T(TO)2}$	$(I > \pi \times I_{T(AV)})$ , $T_J = T_J$ maximum			1.48	
Low level value of forward slope resistance	$r_{f1}$	$(16.7\% \times \pi \times I_{T(AV)} < I < \pi \times I_{T(AV)})$ , $T_J = T_J$ maximum			0.57	mΩ
High level value of forward slope resistance	$r_{f2}$	$(I > \pi \times I_{T(AV)})$ , $T_J = T_J$ maximum			0.56	
Maximum holding current	$I_H$	$T_J = 25$ °C, $I_T > 30$ A			600	mA
Typical latching current	$I_L$	$T_J = 25$ °C, $V_A = 12$ V, $R_a = 6$ Ω, $I_G = 1$ A			1000	



SWITCHING				
PARAMETER	SYMBOL	TEST CONDITIONS	VALUES	UNITS
Maximum non-repetitive rate of rise of turned on current	$di/dt$	$T_J = T_J$ maximum, $V_{DRM} = \text{rated } V_{DRM}$ $I_{TM} = 2 \times di/dt$	1000	A/ $\mu$ s
Typical delay time	$t_d$	$T_J = 25^\circ\text{C}$ , $V_{DM} = \text{Rated } V_{DRM}$ , $I_{TM} = 50 \text{ A DC}$ , $t_p = 1 \mu\text{s}$ Resistive load, gate pulse: 10 V, 5 $\Omega$ source	0.83	$\mu$ s
Maximum turn-off time <sup>(1)</sup>	$t_q$	$T_J = T_J$ maximum, $I_{TM} = 550 \text{ A}$ , commutating $di/dt = 40 \text{ A}/\mu\text{s}$ $V_R = 50 \text{ V}$ , $t_p = 500 \mu\text{s}$ , $dV/dt$ : See table in device code	10	
			30	

**Note**

<sup>(1)</sup>  $t_q = 10$  to  $20 \mu\text{s}$  for 400 to 800 V devices;  $t_q = 15$  to  $30 \mu\text{s}$  for 1000 to 1200 V devices

BLOCKING				
PARAMETER	SYMBOL	TEST CONDITIONS	VALUES	UNITS
Maximum critical rate of rise of off-state voltage	$dV/dt$	$T_J = T_J$ maximum, linear to 80 % $V_{DRM}$ , higher value available on request	500	V/ $\mu$ s
Maximum peak reverse and off-state leakage current	$I_{RRM}$ , $I_{DRM}$	$T_J = T_J$ maximum, rated $V_{DRM}/V_{RRM}$ applied	50	mA

TRIGGERING				
PARAMETER	SYMBOL	TEST CONDITIONS	VALUES	UNITS
Maximum peak gate power	$P_{GM}$	$T_J = T_J$ maximum, $f = 50 \text{ Hz}$ , $d\% = 50$	60	W
Maximum average gate power	$P_{G(AV)}$		10	
Maximum peak positive gate current	$I_{GM}$	$T_J = T_J$ maximum, $t_p \leq 5 \text{ ms}$	10	A
Maximum peak positive gate voltage	+ $V_{GM}$		20	V
Maximum peak negative gate voltage	- $V_{GM}$		5	
Maximum DC gate current required to trigger	$I_{GT}$	$T_J = 25^\circ\text{C}$ , $V_A = 12 \text{ V}$ , $R_a = 6 \Omega$	200	mA
Maximum DC gate voltage required to trigger	$V_{GT}$		3	V
Maximum DC gate current not to trigger	$I_{GD}$	$T_J = T_J$ maximum, rated $V_{DRM}$ applied	20	mA
Maximum DC gate voltage not to trigger	$V_{GD}$		0.25	V

THERMAL AND MECHANICAL SPECIFICATIONS				
PARAMETER	SYMBOL	TEST CONDITIONS	VALUES	UNITS
Maximum operating junction temperature range	$T_J$		- 40 to 125	$^\circ\text{C}$
Maximum storage temperature range	$T_{Stg}$		- 40 to 150	
Maximum thermal resistance, junction to heatsink	$R_{thJ-hs}$	DC operation single side cooled	0.11	K/W
		DC operation double side cooled	0.05	
Maximum thermal resistance, case to heatsink	$R_{thC-hs}$	DC operation single side cooled	0.011	
		DC operation double side cooled	0.005	
Mounting force, $\pm 10 \%$			9800 (1000)	N (kg)
Approximate weight			250	g
Case style		See dimensions - link at the end of datasheet	TO-200AC (B-PUK)	

# ST303CLPbF Series



Vishay High Power Products Inverter Grade Thyristors  
(Hockey PUK Version), 515 A

$\Delta R_{thJ-hs}$ CONDUCTION						
CONDUCTION ANGLE	SINUSOIDAL CONDUCTION		RECTANGULAR CONDUCTION		TEST CONDITIONS	UNITS
	SINGLE SIDE	DOUBLE SIDE	SINGLE SIDE	DOUBLE SIDE		
180°	0.012	0.010	0.008	0.008	T <sub>J</sub> = T <sub>J</sub> maximum	K/W
120°	0.014	0.015	0.014	0.014		
90°	0.018	0.018	0.019	0.019		
60°	0.026	0.027	0.027	0.028		
30°	0.045	0.046	0.046	0.046		

**Note**

- The table above shows the increment of thermal resistance  $R_{thJ-hs}$  when devices operate at different conduction angles than DC

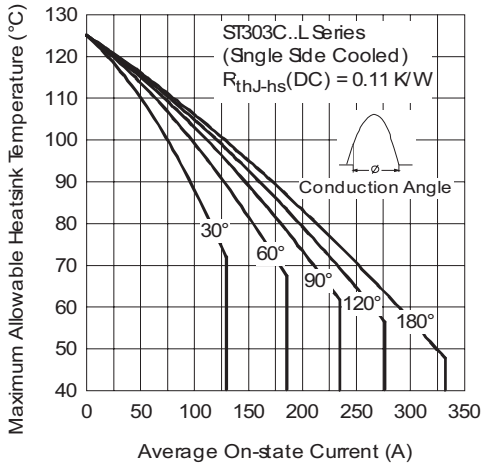

Fig. 1 - Current Ratings Characteristics

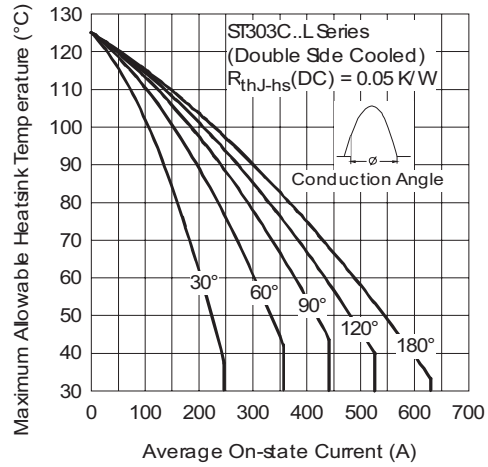

Fig. 3 - Current Ratings Characteristics

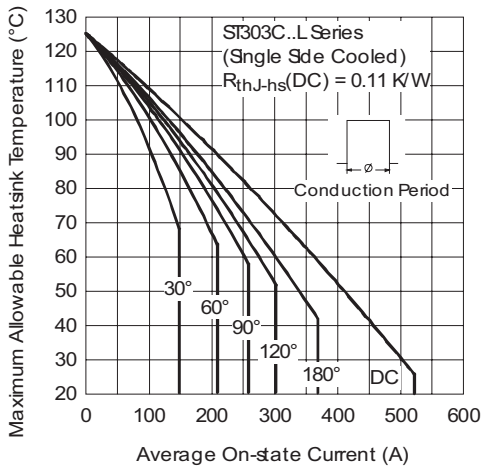

Fig. 2 - Current Ratings Characteristics

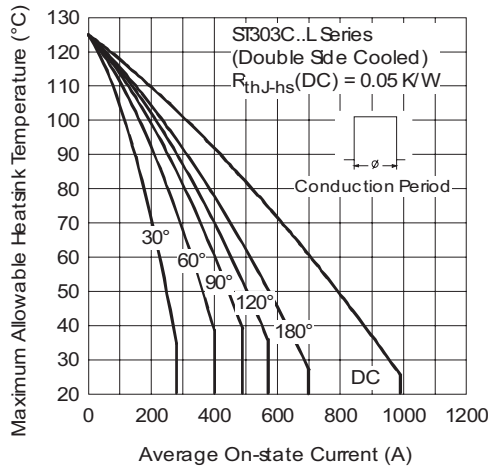

Fig. 4 - Current Ratings Characteristics

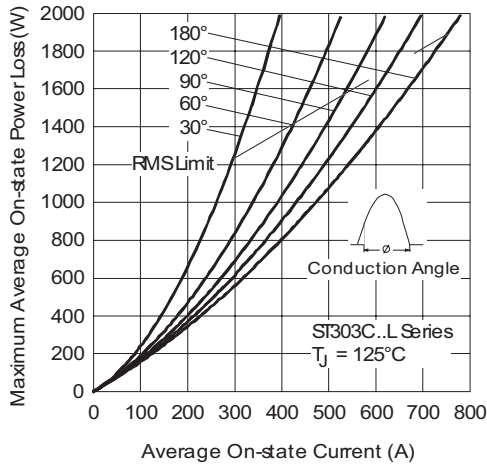

Fig. 5 - On-State Power Loss Characteristics

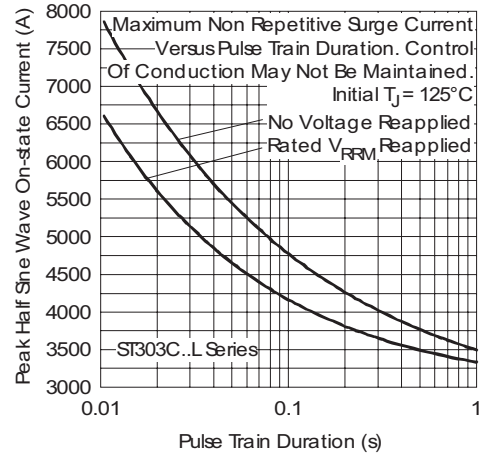

Fig. 8 - Maximum Non-Repetitive Surge Current Single and Double Side Cooled

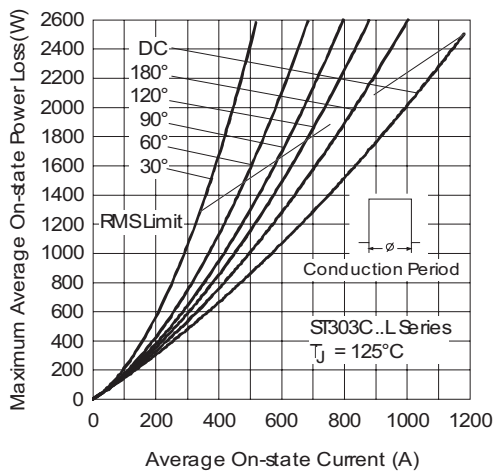

Fig. 6 - On-state Power Loss Characteristics

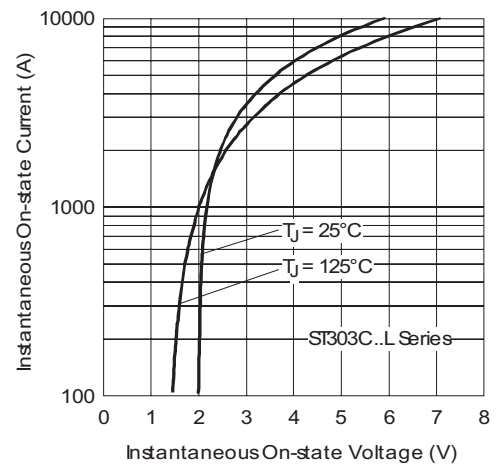

Fig. 9 - On-state Voltage Drop Characteristics

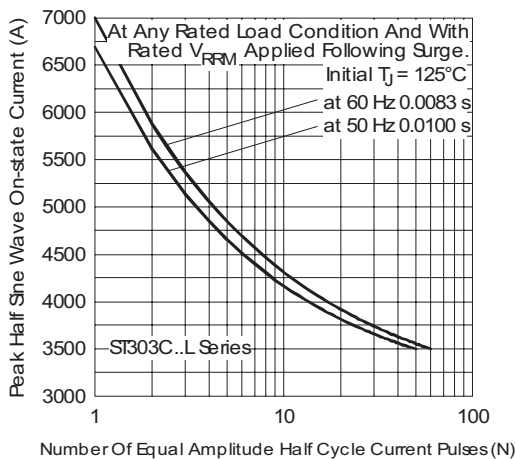

Fig. 7 - Maximum Non-Repetitive Surge Current Single and Double Side Cooled

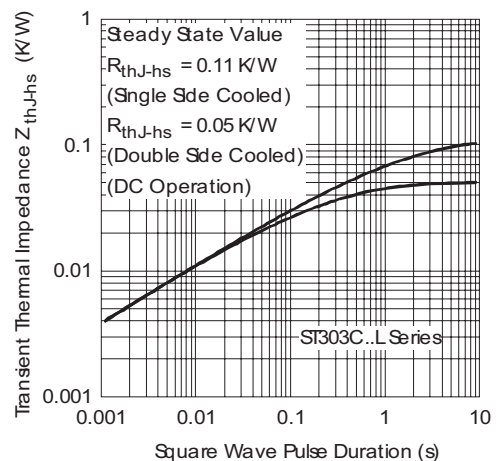

Fig. 10 - Thermal Impedance  $Z_{thJ-hs}$  Characteristics

# ST303CLPbF Series

Vishay High Power Products Inverter Grade Thyristors  
(Hockey PUK Version), 515 A

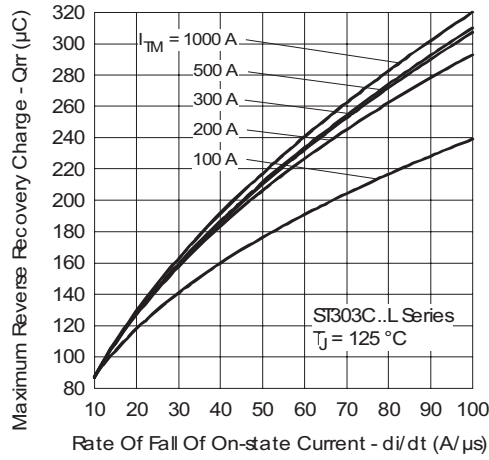

Fig. 11 - Reverse Recovered Charge Characteristics

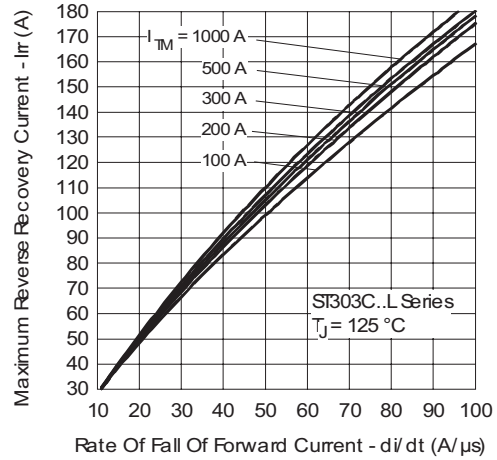

Fig. 12 - Reverse Recovery Current Characteristics

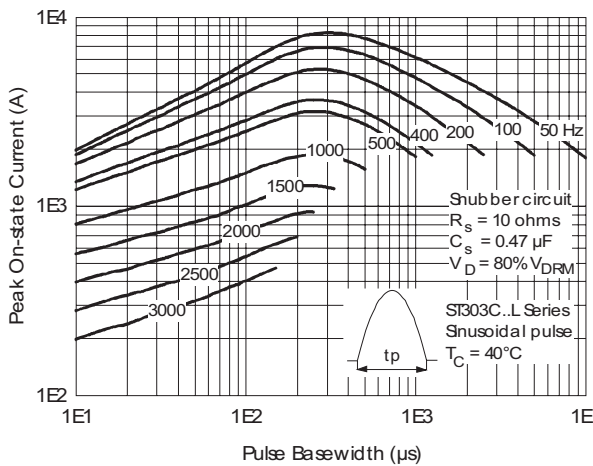

Fig. 13 - Frequency Characteristics

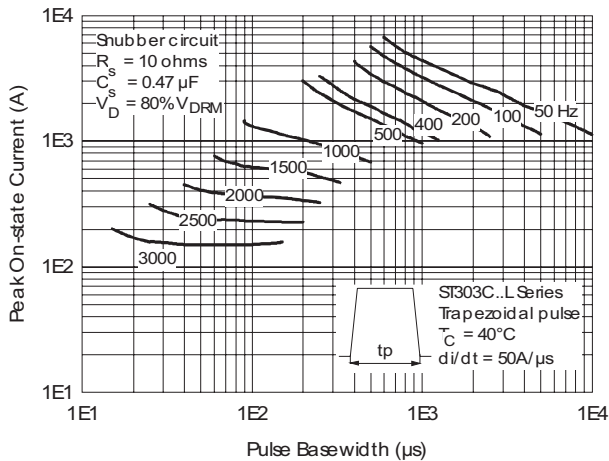
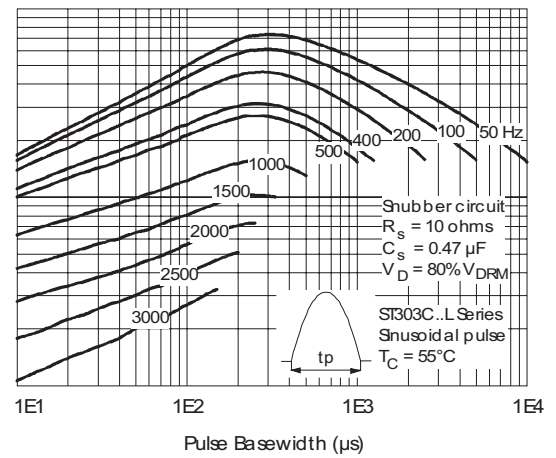
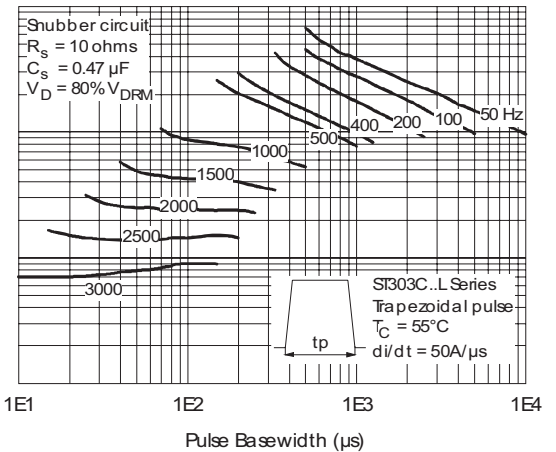

Fig. 14 - Frequency Characteristics



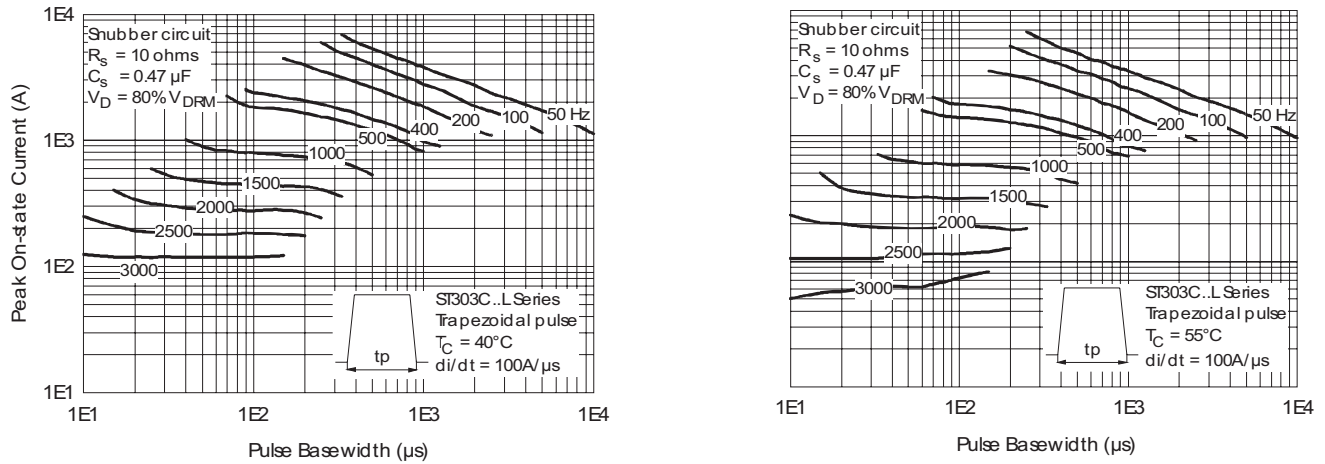

Fig. 15 - Frequency Characteristics

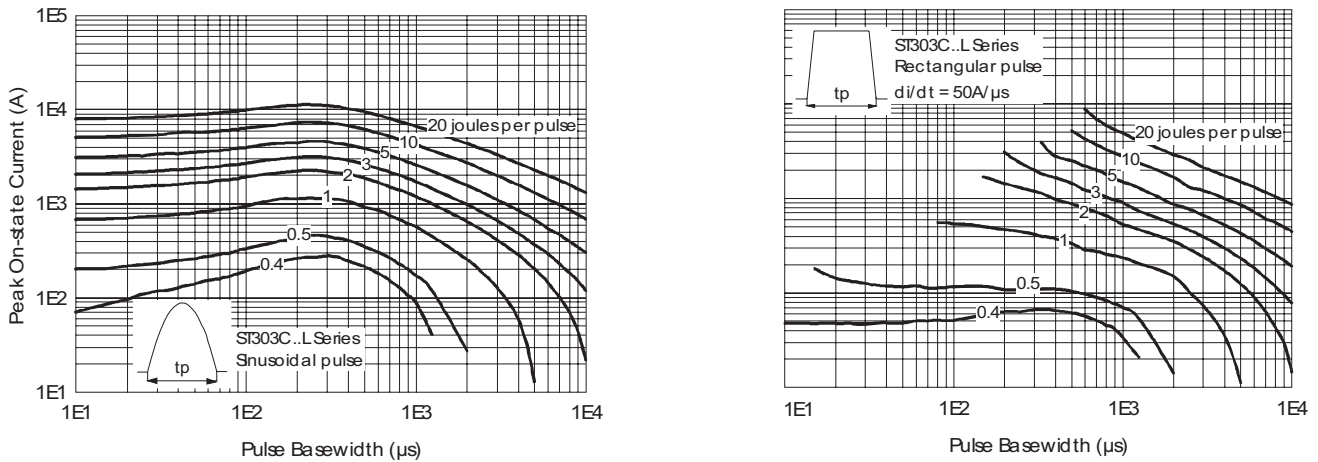

Fig. 16 - Maximum On-State Energy Power Loss Characteristics

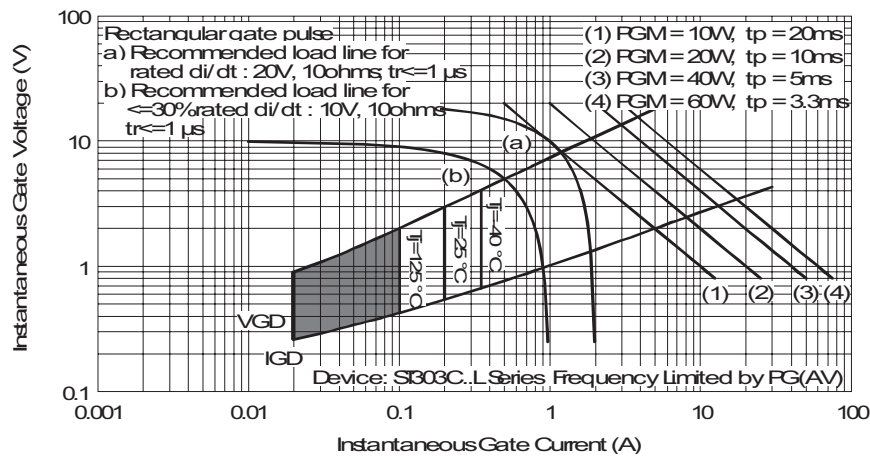

Fig. 17 - Gate Characteristics

# ST303CLPbF Series



Vishay High Power Products Inverter Grade Thyristors  
(Hockey PUK Version), 515 A

## ORDERING INFORMATION TABLE

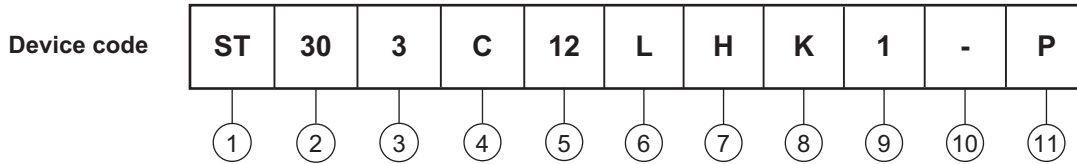

- 1** - Thyristor
- 2** - Essential part number
- 3** - 3 = Fast turn-off
- 4** - C = Ceramic PUK
- 5** - Voltage code x 100 =  $V_{RRM}$   
(see Voltage Ratings table)
- 6** - C = PUK case TO-200AC (B-PUK)
- 7** - Reapplied dV/dt code (for  $t_q$  test condition)
- 8** -  $t_q$  code
- 9** - 0 = Eyelet terminals  
(gate and auxiliary cathode unsoldered leads)  
1 = Fast-on terminals  
(gate and auxiliary cathode unsoldered leads)  
2 = Eyelet terminals  
(gate and auxiliary cathode soldered leads)  
3 = Fast-on terminals  
(gate and auxiliary cathode soldered leads)
- 10** - Critical dV/dt:
  - None = 500 V/ $\mu$ s (standard value)
  - L = 1000 V/ $\mu$ s (special selection)
- 11** - P = Lead (Pb)-free

dV/dt - $t_q$ combinations available							
	dV/dt (V/ $\mu$ s)	20	50	100	200	400	
$t_q$ ( $\mu$ s)	10	CN	DN	EN	<b>FN*</b>	HN	
	12	CM	DM	EM	<b>FM*</b>	HM	
	up to 800 V	15	CL	DL	EL	<b>FL*</b>	HL
		20	CK	DK	EK	<b>FK*</b>	HK
$t_q$ ( $\mu$ s)	15	CL	-	-	-	-	
	18	CP	DP	-	-	-	
	only for 1000/1200 V	20	CK	DK	EK	<b>FK*</b>	HK
		25	CJ	DJ	EJ	<b>FJ*</b>	HJ
	30	-	DH	EH	FH	HH	

\* Standard part number.  
All other types available only on request.

LINKS TO RELATED DOCUMENTS	
Dimensions	<a href="http://www.vishay.com/doc?95076">http://www.vishay.com/doc?95076</a>





## Disclaimer

All product specifications and data are subject to change without notice.

Vishay Intertechnology, Inc., its affiliates, agents, and employees, and all persons acting on its or their behalf (collectively, "Vishay"), disclaim any and all liability for any errors, inaccuracies or incompleteness contained herein or in any other disclosure relating to any product.

Vishay disclaims any and all liability arising out of the use or application of any product described herein or of any information provided herein to the maximum extent permitted by law. The product specifications do not expand or otherwise modify Vishay's terms and conditions of purchase, including but not limited to the warranty expressed therein, which apply to these products.

No license, express or implied, by estoppel or otherwise, to any intellectual property rights is granted by this document or by any conduct of Vishay.

The products shown herein are not designed for use in medical, life-saving, or life-sustaining applications unless otherwise expressly indicated. Customers using or selling Vishay products not expressly indicated for use in such applications do so entirely at their own risk and agree to fully indemnify Vishay for any damages arising or resulting from such use or sale. Please contact authorized Vishay personnel to obtain written terms and conditions regarding products designed for such applications.

Product names and markings noted herein may be trademarks of their respective owners.