

Small Signal Diode



Features

- ✧Fast switching speed
- ✧Surface device type mounting
- ✧Moisture sensitivity level 1
- ✧Matte Tin(Sn) lead finish with Nickel(Ni) underplate
- ✧Pb free version and RoHS compliant
- ✧Green compound (Halogen free) with suffix "G" on packing code and prefix "G" on date code

Mechanical Data

- ✧Case :SOT-23 small outline plastic package
- ✧Terminal: Matte tin plated, lead free., solderable per MIL-STD-202, Method 208 guaranteed
- ✧High temperature soldering guaranteed: 260°C/10s
- ✧Weight : 0.008gram (approximately)
- ✧Marking Code : A1,A4,A7

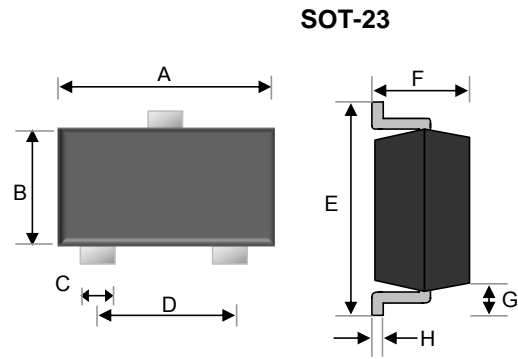

Dimensions	Unit (mm)		Unit (inch)	
	Min	Max	Min	Max
A	2.80	3.00	0.110	0.118
B	1.20	1.40	0.047	0.055
C	0.30	0.50	0.012	0.020
D	1.80	2.00	0.071	0.079
E	2.25	2.55	0.089	0.100
F	0.90	1.20	0.035	0.047
G	0.550 REF		0.022 REF	
H	0.08	0.19	0.003	0.010

Pin Configuration

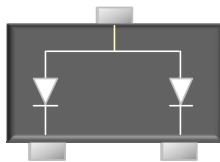

BAW56

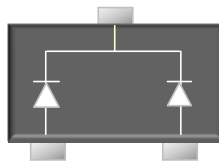

BAV70

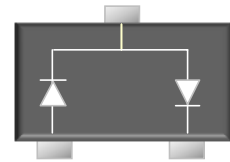

BAV99

Ordering Information

Package	Part No.	Packing	Marking
SOT-23	BAW56 RF	3K / 7" Reel	A1
SOT-23	BAV70 RF	3K / 7" Reel	A4
SOT-23	BAV99 RF	3K / 7" Reel	A7
SOT-23	BAW56 RFG	3K / 7" Reel	A1
SOT-23	BAV70 RFG	3K / 7" Reel	A4
SOT-23	BAV99 RFG	3K / 7" Reel	A7

Suggested PAD Layout

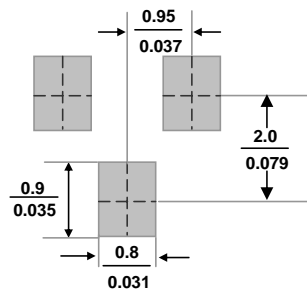

Maximum Ratings and Electrical Characteristics

Rating at 25°C ambient temperature unless otherwise specified.

Maximum Ratings

Type Number	Symbol	Value	Units
Power Dissipation	P _D	225	mW
Repetitive Peak Reverse Voltage	V _{RRM}	70	V
Repetitive Peak Forward Current	I _{FRM}	450	mA
Mean Forward Current	I _O	200	mA
Non-Repetitive Peak Forward Surge Current Pulse Width=1 sec Pulse Width=1 μsec	I _{FSM}	0.5	A
		2	
Thermal Resistance (Junction to Ambient)	R _{θJA}	357	°C/W
Junction and Storage Temperature Range	T _J , T _{STG}	-55 to + 150	°C

Small Signal Diode

Electrical Characteristics

Rating at 25°C ambient temperature unless otherwise specified.

Type Number		Symbol	Min	Max	Units
Reverse Breakdown Voltage	$I_R = 100\mu A$	$V_{(BR)}$	70	-	V
Forward Voltage	$I_F = 50mA$	V_F	-	1.00	V
	$I_F = 150mA$		-	1.25	V
Reverse Leakage Current	$V_R = 70V$	I_R	-	2.50	μA
Junction Capacitance	$V_R = 0V, f = 1.0MHz$	C_J	-	1.5	pF
Reverse Recovery Time	$I_F = I_R = 10mA, R_L = 100\Omega, I_{RR} = 1mA$	T_{rr}	-	6.0	ns

Tape & Reel specification

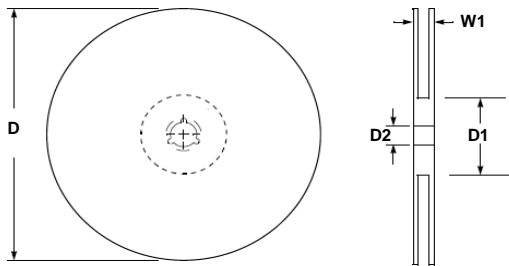
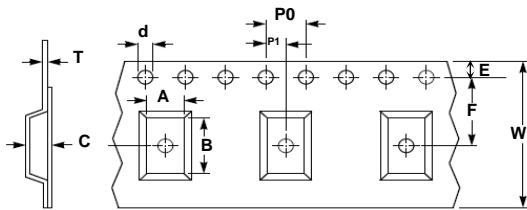
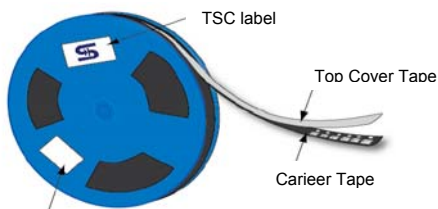

Item	Symbol	Dimension(mm)
Carrier width	A	3.15 ±0.10
Carrier length	B	2.77 ±0.10
Carrier depth	C	1.22 ±0.10
Sprocket hole	d	1.50 ± 0.10
Reel outside diameter	D	178 ± 1
Reel inner diameter	D1	55 Min
Feed hole width	D2	13.0 ± 0.20
Sprocket hole position	E	1.75 ±0.10
Punch hole position	F	3.50 ±0.05
Sprocket hole pitch	P0	4.00 ±0.10
Embossment center	P1	2.00 ±0.05
Overall tape thickness	T	0.229 ±0.013
Tape width	W	8.10 ±0.20
Reel width	W1	12.30 ±0.20

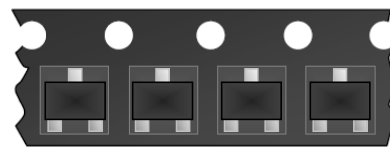

Direction of Feed →

Small Signal Diode

Rating and Characteristic Curves

FIG 1 Typical Forward Characteristics

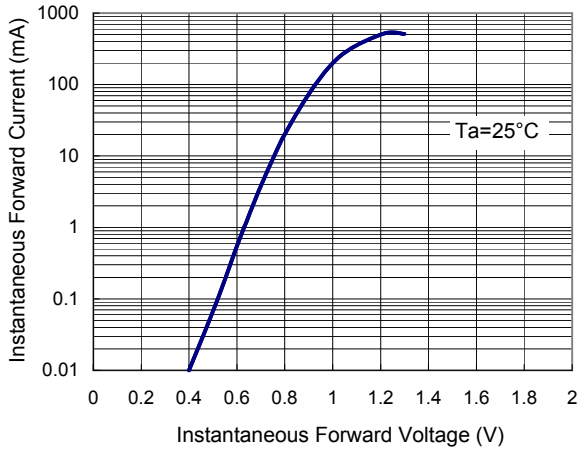

FIG 2 Leakage Current vs Junction Temperature.

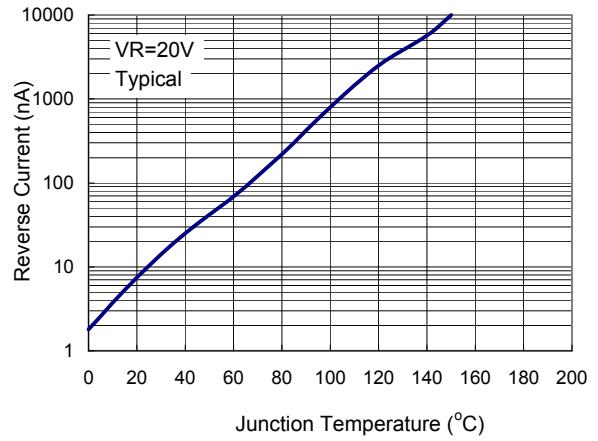

FIG 3 Power Dissipation Derating Curve

