

KM4100/KM4101

Low Cost, +2.7V and +5V, 260MHz Rail-to-Rail Amplifiers

Features

- 260MHz bandwidth
- Fully specified at +2.7V and +5V supplies
- Output voltage range:
0.036V to 4.953V; $V_S = +5$; $R_L = 2k\Omega$
- Input voltage range: -0.3V to +3.8V; $V_S = +5$
- 150V/ μ s slew rate
- 4.2mA supply current
- Power down to $I_S = 127\mu$ A (KM4101)
- ± 60 mA linear output current
- ± 90 mA output short circuit current
- Directly replaces AD8051 and LM7131 in single supply applications
- Small package options (SOT-23, SOIC)

Applications

- A/D driver
- Active filters
- CCD imaging systems
- CD/DVD ROM
- Coaxial cable drivers
- High capacitive load driver
- Portable/battery-powered applications
- Twisted pair driver
- Video driver

KM4100/KM4101 Packages

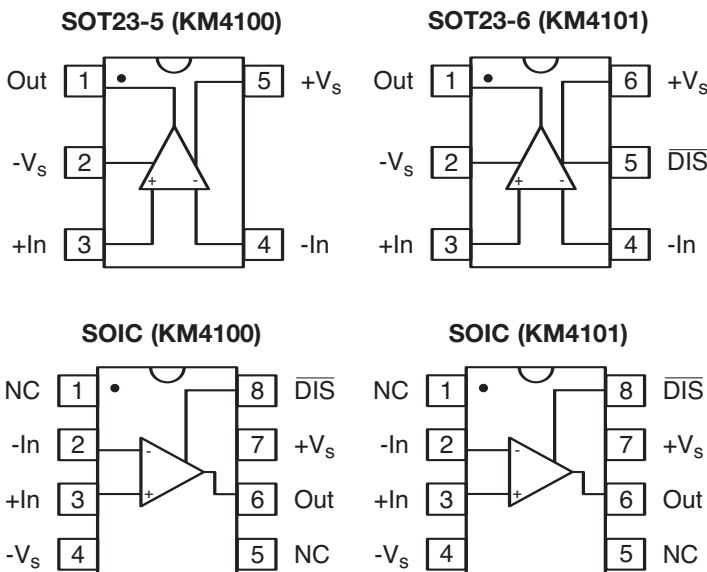

General Description

The KM4100 (single) and KM4101 (single with disable) are low cost, voltage feedback amplifiers. These amplifiers are designed to operate on +2.7V, +5V, or ± 2.5 V supplies. The input voltage range extends 300mV below the negative rail and 1.2V below the positive rail.

The KM4100 offers superior dynamic performance with a 260MHz small signal bandwidth and 150V/ μ s slew rate. The combination of low power, high output current drive, and rail-to-rail performance make the KM4100 well suited for battery-powered communication/computing systems.

The combination of low cost and high performance make the KM4100 suitable for high volume applications in both consumer and industrial applications such as wireless phones, scanners, and color copiers.

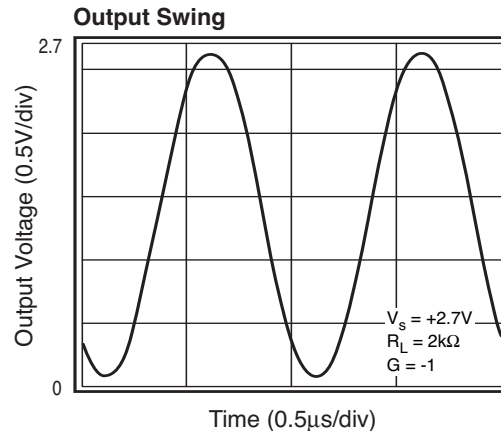

KM4100/KM4101 Electrical Characteristics ($V_s = +2.7V$, $G = 2$, $R_L = 2k\Omega$ to $V_s/2$; unless noted)

Parameters	Conditions	TYP	Min & Max	UNITS	NOTES
Case Temperature		+25°C	+25°C		
Frequency Domain Response					
-3dB bandwidth	$G = +1$, $V_O = 0.05V_{pp}$	215		MHz	1
	$G = +2$, $V_O = 0.2V_{pp}$	85		MHz	
full power bandwidth	$G = +2$, $V_O = 2V_{pp}$	36		MHz	
gain bandwidth product		86		MHz	
Time Domain Response					
rise and fall time	0.2V step	3.7		ns	1
settling time to 0.1%	1V step	40		ns	
overshoot	0.2V step,	9		%	
slew rate	2.7V step, $G = -1$	140		V/ μ s	
Distortion and Noise Response					
2nd harmonic distortion	$1V_{pp}$, 5MHz	86		dBc	1
3rd harmonic distortion	$1V_{pp}$, 5MHz	85		dBc	1
THD	$1V_{pp}$, 5MHz	76		dB	1
input voltage noise	>1MHz	16		nV/ \sqrt{Hz}	
input current noise	>1MHz	1.3		pA/ \sqrt{Hz}	
DC Performance					
input offset voltage		-1.6	± 8	mV	2
average drift		10		μ V/ $^{\circ}C$	
input bias current		3	± 8	μ A	2
average drift		7		nA/ $^{\circ}C$	
input offset current		0	± 1	μ A	2
power supply rejection ratio	DC	57	52	dB	2
open loop gain		75	65	dB	2
quiescent current		3.9	5	mA	2
quiescent current (disabled)		58	100	μ A	2
Input Characteristics					
input resistance		4.3		M Ω	
input capacitance		1.5		pF	
input common mode voltage range		-0.3 to 1.5		V	
common mode rejection ratio	DC, $V_{cm} = 0V$ to $V_s - 1.5$	87	72	dB	2
Disable Characteristics (KM4101)					
turn on time		150		ns	
turn off time		25		ns	
off isolation	5MHz, $R_L = 100\Omega$	75		dB	
Output Characteristics					
output voltage swing	$R_L = 10k\Omega$ to $V_s/2$	0.023 to 2.66		V	2
	$R_L = 2k\Omega$ to $V_s/2$	0.025 to 2.653	0.1 to 2.6	V	
	$R_L = 150\Omega$ to $V_s/2$	0.065 to 2.55	0.3 to 2.325	V	
linear output current		± 60		mA	2
		± 55		mA	
		± 90		mA	
short circuit output current	-40°C to +85°C	2.7	2.5 to 5.5	V	

Min/max ratings are based on product characterization and simulation. Individual parameters are tested as noted. Outgoing quality levels are determined from tested parameters.

NOTES:

- 1) $R_f = 1k\Omega$ was used for optimal performance. (For $G = +1$, $R_f = 0$)
- 2) 100% tested at +25°C.

Absolute Maximum Ratings

supply voltage	0 to +6V
maximum junction temperature	+175°C
storage temperature range	-65°C to +150°C
lead temperature (10 sec)	+300°C
operating temperature range (recommended)	-40°C to +85°C
input voltage range	+ V_s +0.5V; - V_s -0.5V
internal power dissipation	see power derating curves

Package Thermal Resistance

Package	θ_{JA}
5 lead SOT23	256°C/W
6 lead SOT23	230°C/W
8 lead SOIC	152°C/W

KM4100/KM4101 Electrical Characteristics ($V_s = +5V$, $G = 2$, $R_L = 2k\Omega$ to $V_s/2$; unless noted)

Parameters	Conditions	TYP	Min & Max	UNITS	NOTES
Case Temperature		+25°C	+25°C		
Frequency Domain Response					
-3dB bandwidth	$G = +1$, $V_O = 0.05V_{pp}$	260		MHz	1
full power bandwidth	$G = +2$, $V_O = 0.2V_{pp}$	90		MHz	
gain bandwidth product	$G = +2$, $V_O = 2V_{pp}$	40		MHz	
		90		MHz	
Time Domain Response					1
rise and fall time	0.2V step	3.6		ns	
settling time to 0.1%	2V step	40		ns	
overshoot	0.2V step,	7		%	
slew rate	5V step, $G = -1$	150		V/ μ s	
Distortion and Noise Response					
2nd harmonic distortion	$2V_{pp}$, 5MHz	70		dBc	1
3rd harmonic distortion	$2V_{pp}$, 5MHz	78		dBc	1
THD	$2V_{pp}$, 5MHz	68		dB	1
input voltage noise	>1MHz	16		nV/ \sqrt{Hz}	
input current noise	>1MHz	1.3		pA/ \sqrt{Hz}	
DC Performance					
input offset voltage		1.4	± 8	mV	2
average drift		10		μ V/ $^{\circ}$ C	
input bias current		3	± 8	μ A	2
average drift		7		nA/ $^{\circ}$ C	
input offset current		0	± 0.8	μ A	2
power supply rejection ratio	DC	57	52	dB	2
open loop gain		78	68	dB	2
quiescent current		4.2	5.2	mA	2
quiescent current (disabled)		127	170	μ A	2
Input Characteristics					
input resistance		4.3		M Ω	
input capacitance		1.5		pF	
input common mode voltage range		-0.3 to 3.8		V	
common mode rejection ratio	DC, $V_{cm} = 0V$ to $V_s - 1.5$	87	72	dB	2
Disable Characteristics (KM4101)					
turn on time		150		ns	
turn off time		25		ns	
off isolation	5MHz, $R_L = 100\Omega$	75		dB	
Output Characteristics					
output voltage swing	$R_L = 10k\Omega$ to $V_s/2$	0.027 to 4.97		V	
	$R_L = 2k\Omega$ to $V_s/2$	0.036 to 4.953	0.1 to 4.9	V	2
	$R_L = 150\Omega$ to $V_s/2$	0.12 to 4.8	0.3 to 4.625	V	2
linear output current		± 60		mA	
		± 55		mA	
short circuit output current		± 90		mA	
power supply operating range	-40°C to +85°C	5	2.5 to 5.5	V	

Min/max ratings are based on product characterization and simulation. Individual parameters are tested as noted. Outgoing quality levels are determined from tested parameters.

NOTES:

- 1) $R_f = 1k\Omega$ was used for optimal performance. (For $G = +1$, $R_f = 0$)
- 2) 100% tested at +25°C.

KM4100/KM4101 Performance Characteristics ($V_s = +5V$, $G = 2$, $R_f = 2k\Omega$, $R_L = 2k\Omega$ to $V_s/2$; unless noted)

Non-Inverting Freq. Response $V_s = +5V$

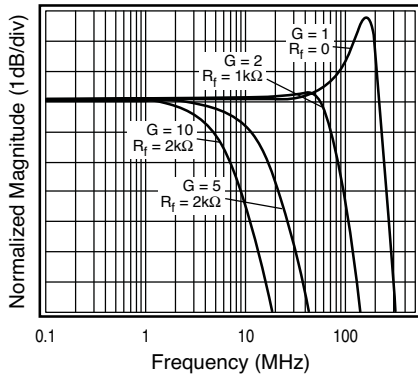

Inverting Freq. Response $V_s = +5V$

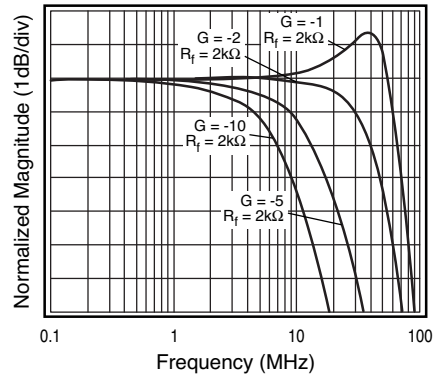

Non-Inverting Freq. Response $V_s = +2.7$

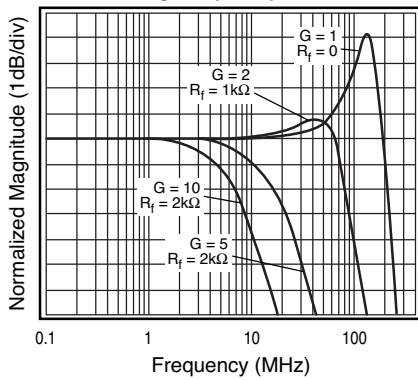

Inverting Freq. Response $V_s = +2.7$

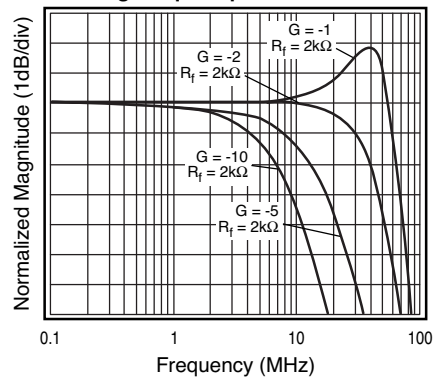

Frequency Response vs. C_L

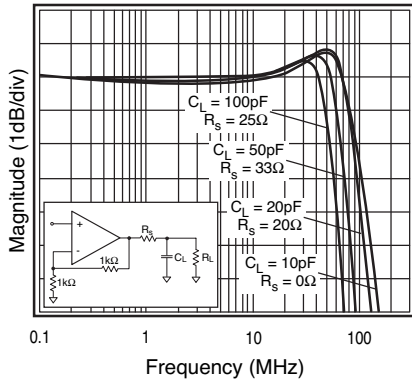

Large Signal Frequency Response

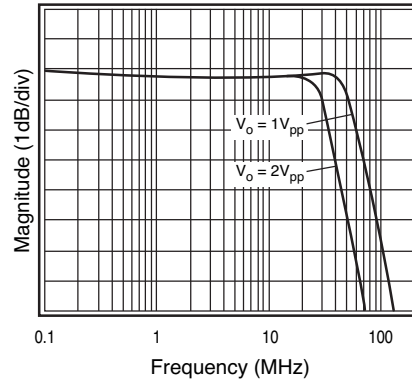

Frequency Response vs. Temperature

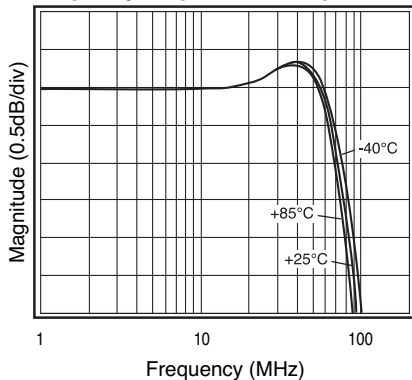

Input Voltage Noise

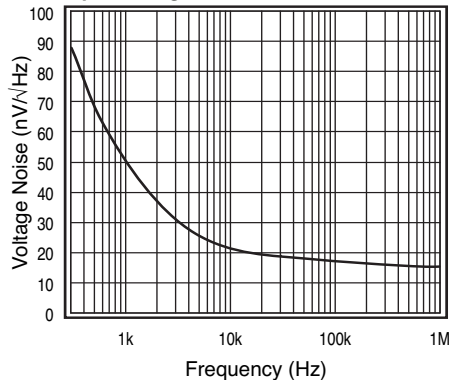

KM4100/KM4101 Performance Characteristics ($V_s = +5V$, $G = 2$, $R_f = 2k\Omega$, $R_L = 2k\Omega$ to $V_s/2$; unless noted)

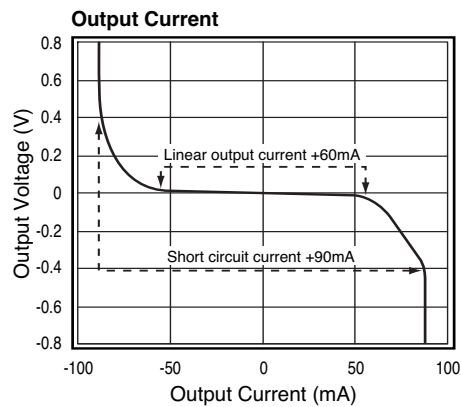
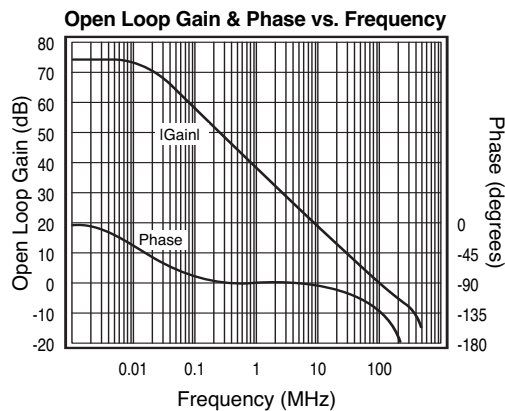
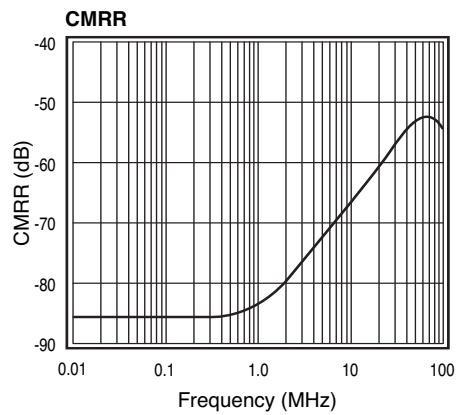
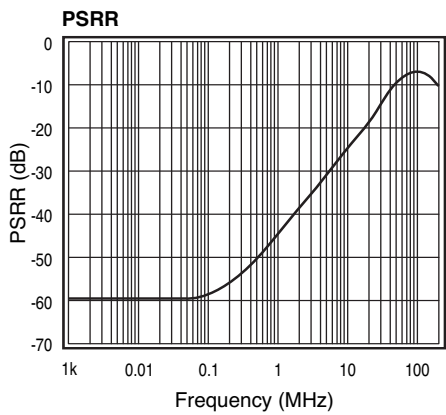
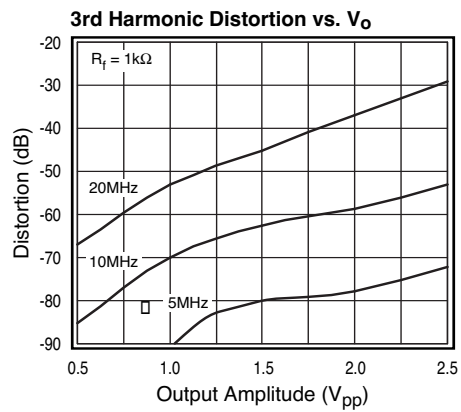
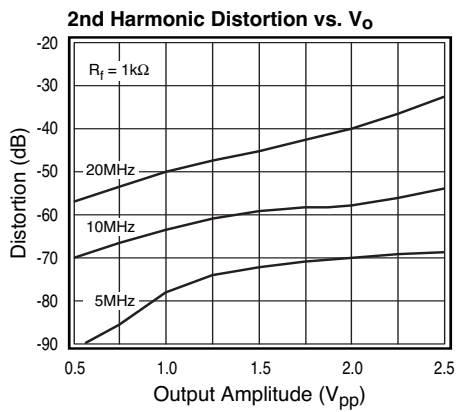
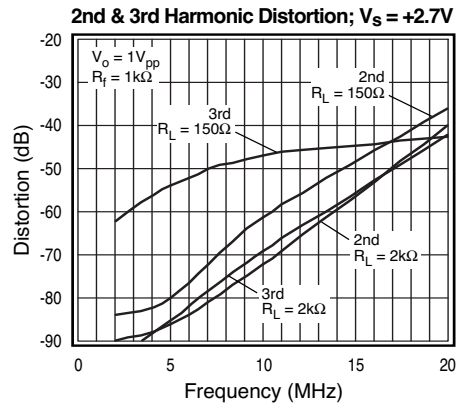
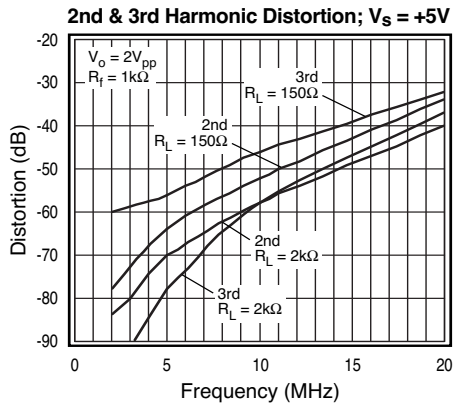

KM4100/KM4101 Performance Characteristics ($V_s = +5V$, $G = 2$, $R_f = 2k\Omega$, $R_L = 2k\Omega$ to $V_s/2$; unless noted)

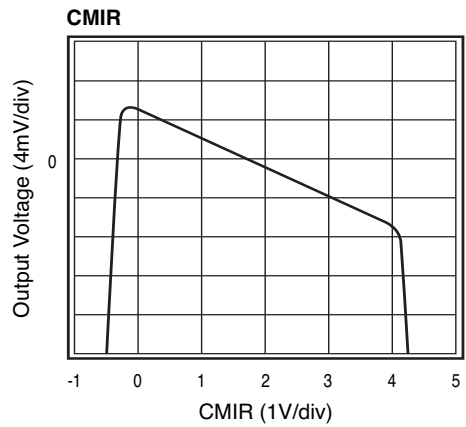
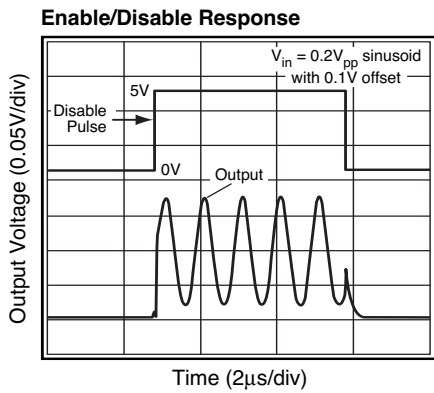
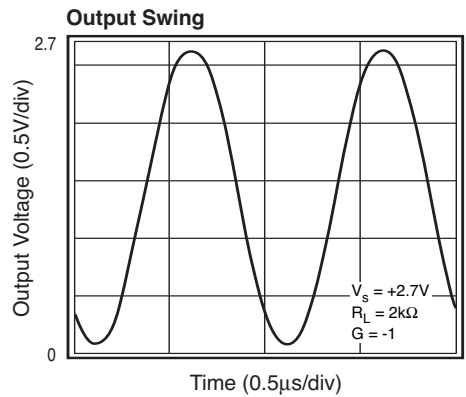
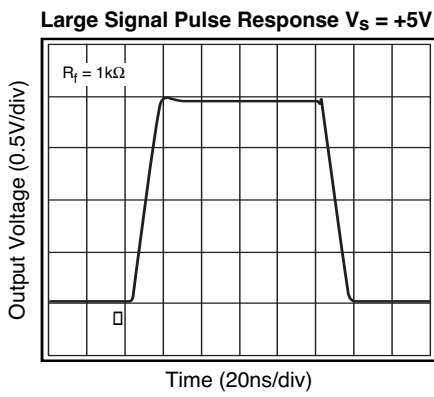
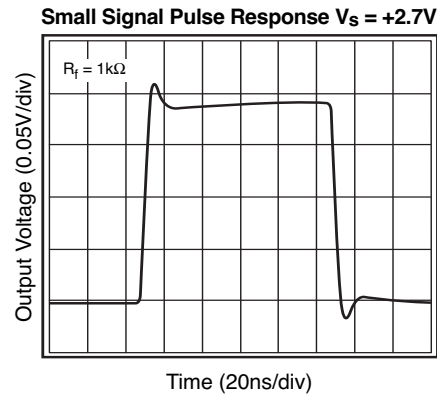
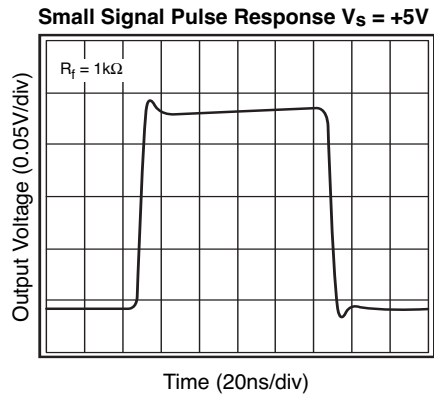

General Description

The KM4100/KM4101 are single supply, general purpose, voltage-feedback amplifiers fabricated on a complementary bipolar process using a patent pending topology. They feature a rail-to-rail output stage and are unity gain stable. Both gain bandwidth and slew rate are insensitive to temperature.

The common mode input range extends to 300mV below ground and to 1.2V below V_s . Exceeding these values will not cause phase reversal. However, if the input voltage exceeds the rails by more than 0.5V, the input ESD devices will begin to conduct. The output will stay at the rail during this overdrive condition.

The design uses a Darlington output stage. The output stage is short circuit protected and offers “soft” saturation protection that improves recovery time.

The typical circuit schematic is shown in Figure 1.

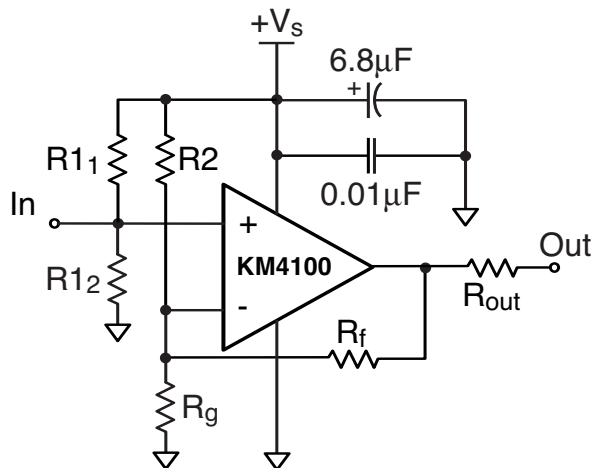

Figure 1: Typical Configuration

At non-inverting gains other than $G = +1$, keep R_g below $1k\Omega$ to minimize peaking; thus, for optimum response at a gain of +2, a feedback resistor of $1k\Omega$ is recommended. Figure 2 illustrates the KM4100/KM4101 frequency response with both $1k\Omega$ and $2k\Omega$ feedback resistors.

Enable/Disable Function (KM4101)

The KM4101 offers an active-low disable pin that can be used to lower its supply current. Leave the pin floating to enable the part. Pull the disable pin to the negative supply (which is ground in a single supply application) to disable the output. During the disable condition, the nominal supply current will drop to below $127\mu A$ and the output will be at high impedance with about $2pF$ capacitance.

Frequency Reponse vs. R_f

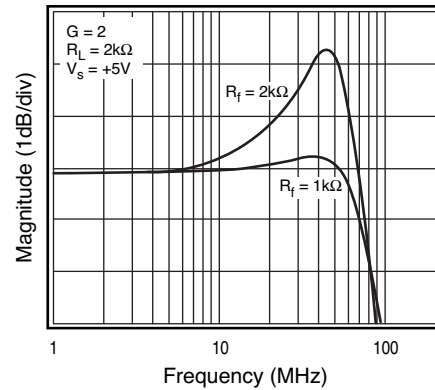

Figure 2: Frequency Response vs. R_f

Power Dissipation

The maximum internal power dissipation allowed is directly related to the maximum junction temperature. If the maximum junction temperature exceeds $150^\circ C$, some reliability degradation will occur. If the maximum junction temperature exceeds $175^\circ C$ for an extended time, device failure may occur.

The KM4100/KM4101 are short circuit protected. However, this may not guarantee that the maximum junction temperature ($+150^\circ C$) is not exceeded under all conditions. Follow the maximum power derating curves shown in Figure 3 to ensure proper operation.

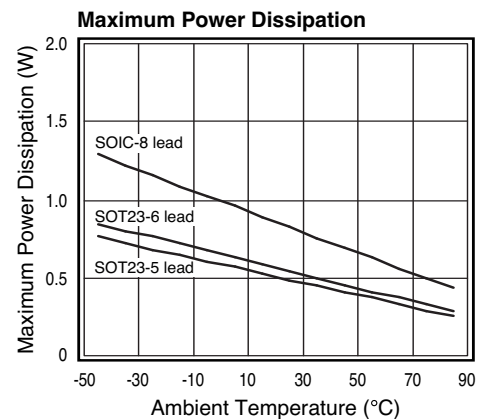

Figure 3: Power Derating Curves

Overdrive Recovery

For an amplifier, an overdrive condition occurs when the output and/or input ranges are exceeded. The recovery time varies based on whether the input or output is overdriven and by how much the ranges are exceeded. The KM4100/KM4101 will typically recover in less than 20ns from an overdrive condition. Figure 4 shows the KM4100 in an overdriven condition.

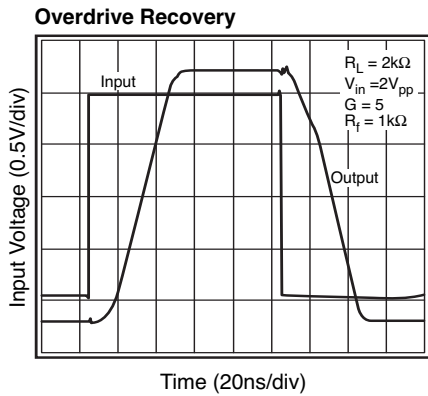

Figure 4: Overdrive Recovery

Driving Capacitive Loads

The Frequency Response vs. C_L plot on page 4, illustrates the response of the KM4100 and KM4101. A small series resistance (R_s) at the output of the amplifier, illustrated in Figure 5, will improve stability and settling performance. R_s values in the Frequency Response vs. C_L plot were chosen to achieve maximum bandwidth with less than 1dB of peaking. For maximum flatness, use a larger R_s .

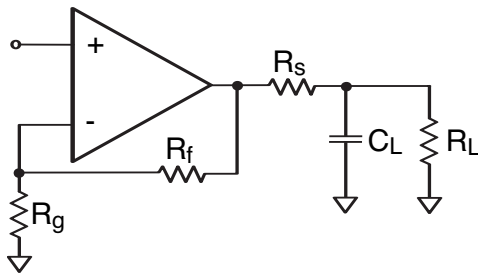

Figure 5: Typical Topology for driving a capacitive load

Layout Considerations

General layout and supply bypassing play major roles in high frequency performance. Fairchild has evaluation boards to use as a guide for high frequency layout and to aid in device testing and characterization. Follow the steps below as a basis for high frequency layout:

- Include 6.8 μ F and 0.01 μ F ceramic capacitors
- Place the 6.8 μ F capacitor within 0.75 inches of the power pin
- Place the 0.01 μ F capacitor within 0.1 inches of the power pin
- Remove the ground plane under and around the part, especially near the input and output pins to reduce parasitic capacitance
- Minimize all trace lengths to reduce series inductances

Refer to the evaluation board layouts shown in Figure 7 for more information.

Evaluation Board Information

The following evaluation boards are available to aid in the testing and layout of this device:

Eval Board	Description	Products
KEB002	Single Channel, Dual Supply 5 & 6 lead SOT23	KM4100IT5, KM4101IT6
KEB003	Single Channel, Dual Supply 8 lead SOIC	KM4100IC8, KM4101IC8

Evaluation board schematics and layouts are shown in Figure 6 and Figure 7.

The KEB002 and KEB003 evaluation boards are built for dual supply operation. Follow these steps to use the board in a single supply application:

1. Short $-V_s$ to ground
2. Use C3 and C4, if the $-V_s$ pin of the KM4100 or KM4101 is not directly connected to the ground plane.

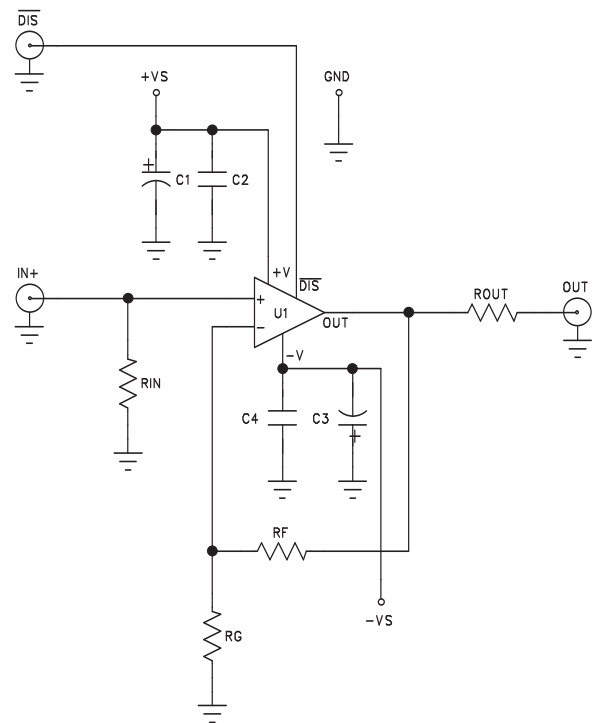

Figure 6: Evaluation Board Schematic (SOIC pinout shown)

KM4100/KM4101 Evaluation Board Layout

KOTA LAYER1 SILK

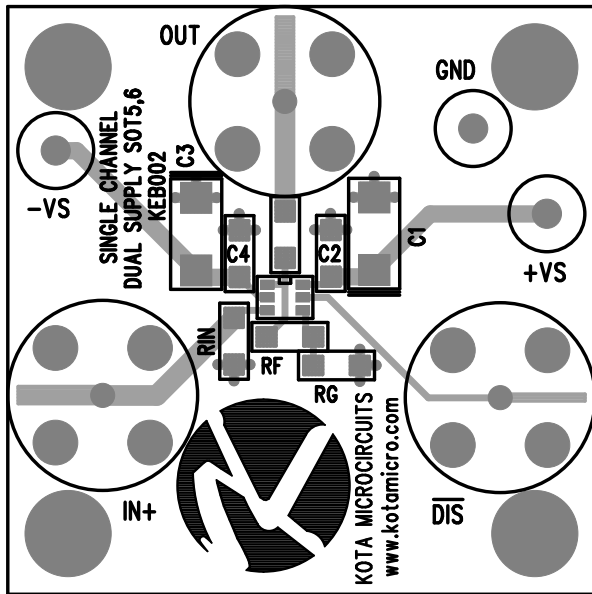

Figure 7a: KEB002 (top side)

KOTA LAYERS SILK

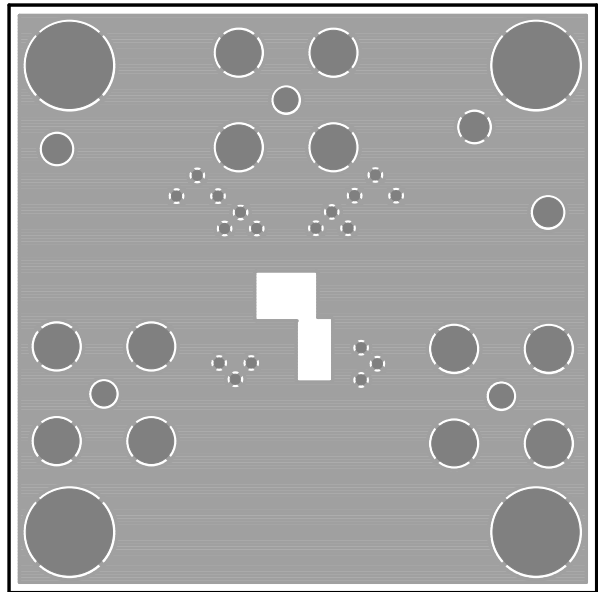

Figure 7b: KEB002 (bottom side)

KOTA LAYER1 SILK

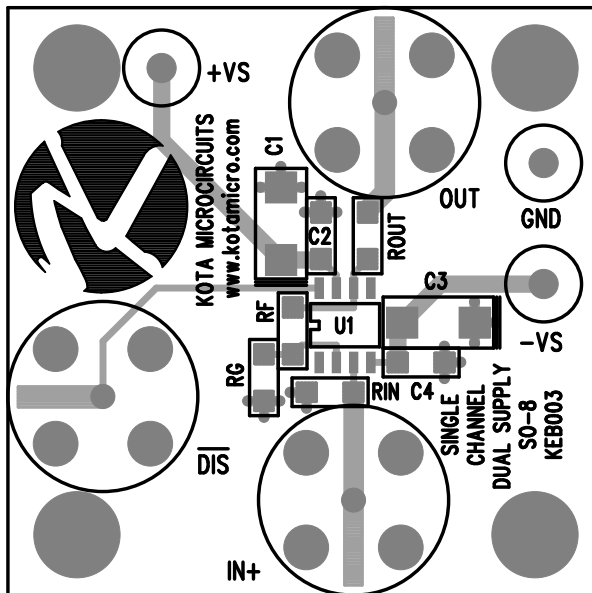

Figure 7c: KEB003 (top side)

KOTA LAYERS SILK

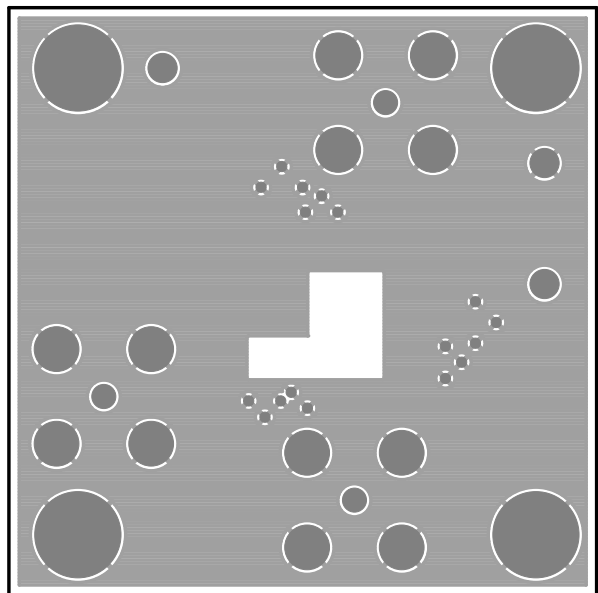
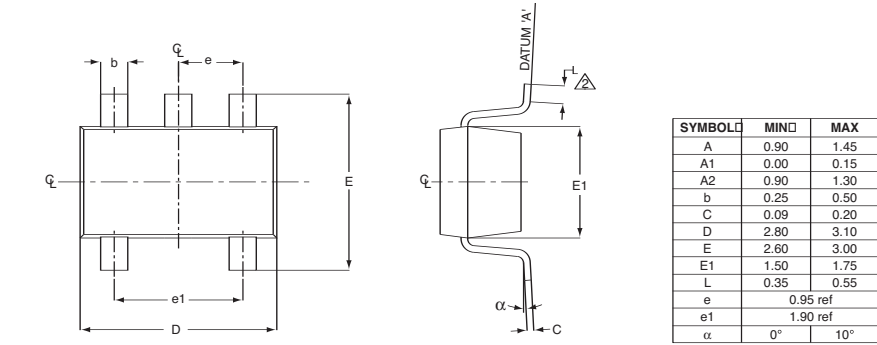

Figure 7d: KEB003 (bottom side)

KM4100/KM4101 Package Dimensions

SOT23-5



NOTE:

- All dimensions are in millimeters.
- Foot length measured reference to flat foot surface parallel to DATUM 'A' and lead surface.
- Package outline exclusive of mold flash & metal burr.
- Package outline inclusive of solder plating.
- Comply to EIAJ SC74A.
- Package ST 0003 REV A supercedes SOT-D-2005 REV C.

SOT23-6

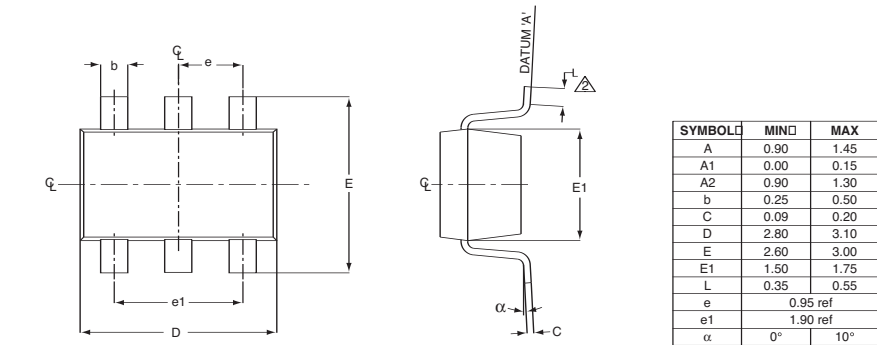

NOTE:

- All dimensions are in millimeters.
- Foot length measured reference to flat foot surface parallel to DATUM 'A' and lead surface.
- Package outline exclusive of mold flash & metal burr.
- Package outline inclusive of solder plating.
- Comply to EIAJ SC74A.
- Package ST 0004 REV A supercedes SOT-D-2006 REV C.

SOIC

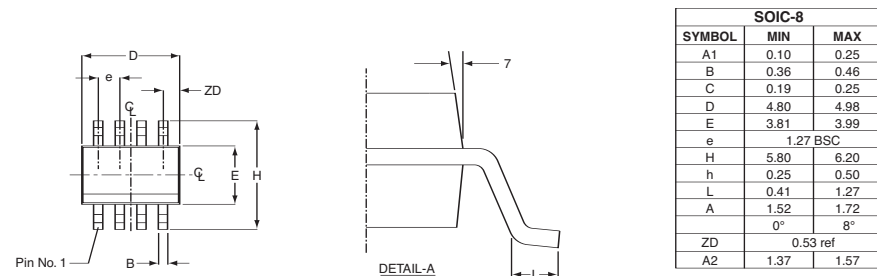

NOTE:

- All dimensions are in millimeters.
- Lead coplanarity should be 0 to 0.10mm (.004") max.
- Package surface finishing:
 - Top: matte (charmillies #18-30).
 - All sides: matte (charmillies #18-30).
 - Bottom: smooth or matte (charmillies #18-30).
- All dimensions excluding mold flashes and end flash from the package body shall not exceed 0.152mm (.006) per side (D).

Ordering Information

Model	Part Number	Lead-Free	Package	Container	Pack Qty
KM4100	KM4100IC8TR3	No	SOIC-8	Reel	3000
KM4100	KM4100IT5TR3	No	SOT23-5	Reel	2500
KM4100	KM4100IT5TR3_NL	Yes	SOT23-5	Reel	2500
KM4101	KM4101IT6TR3	No	SOT23-6	Reel	2500

Temperature range for all parts: -40°C to +85°C

DISCLAIMER

FAIRCHILD SEMICONDUCTOR RESERVES THE RIGHT TO MAKE CHANGES WITHOUT FURTHER NOTICES TO ANY PRODUCTS HEREIN TO IMPROVE RELIABILITY, FUNCTION OR DESIGN. FAIRCHILD DOES NOT ASSUME ANY LIABILITY ARISING OUT OF THE APPLICATION OR USE OF ANY PRODUCT OR CIRCUIT DESCRIBED HEREIN; NEITHER DOES IT CONVEY ANY LICENSE UNDER ITS PATENT RIGHTS, NOR THE RIGHTS OF OTHERS.

LIFE SUPPORT POLICY

FAIRCHILD'S PRODUCTS ARE NOT AUTHORIZED FOR USE AS CRITICAL COMPONENTS IN LIFE SUPPORT DEVICES OR SYSTEMS WITHOUT THE EXPRESS WRITTEN APPROVAL OF THE PRESIDENT OF FAIRCHILD SEMICONDUCTOR CORPORATION. As used herein:

1. Life support devices or systems are devices or systems which, (a) are intended for surgical implant into the body, or (b) support or sustain life, and (c) whose failure to perform when properly used in accordance with instructions for use provided in the labeling, can be reasonably expected to result in a significant injury of the user.
2. A critical component in any component of a life support device or system whose failure to perform can be reasonably expected to cause the failure of the life support device or system, or to affect its safety or effectiveness.