

# MOTOROLA SEMICONDUCTOR TECHNICAL DATA



## 6-Pin DIP Zero-Cross Optoisolators Triac Driver Output (250 Volts Peak)

The MOC3031, MOC3032 and MOC3033 devices consist of gallium arsenide infrared emitting diodes optically coupled to a monolithic silicon detector performing the function of a Zero Voltage crossing bilateral triac driver.

They are designed for use with a triac in the interface of logic systems to equipment powered from 115 Vac lines, such as teletypewriters, CRTs, printers, motors, solenoids and consumer appliances, etc.

- Simplifies Logic Control of 115 Vac Power
- Zero Voltage Crossing
- $dv/dt$  of 2000 V/ $\mu$ s Typical, 1000 V/ $\mu$ s Guaranteed
- **To order devices that are tested and marked per VDE 0884 requirements, the suffix "V" must be included at end of part number. VDE 0884 is a test option.**

### Recommended for 115 Vac(rms) Applications:

- Solenoid/Valve Controls
- Lighting Controls
- Static Power Switches
- AC Motor Drives
- Temperature Controls
- E.M. Contactors
- AC Motor Starters
- Solid State Relays

### MAXIMUM RATINGS ( $T_A = 25^\circ\text{C}$ unless otherwise noted)

Rating	Symbol	Value	Unit
--------	--------	-------	------

#### INFRARED LED

Reverse Voltage	$V_R$	3	Volts
Forward Current — Continuous	$I_F$	60	mA
Total Power Dissipation @ $T_A = 25^\circ\text{C}$ Negligible Power in Output Driver Derate above $25^\circ\text{C}$	$P_D$	120	mW
		1.41	mW/ $^\circ\text{C}$

#### OUTPUT DRIVER

Off-State Output Terminal Voltage	$V_{DRM}$	250	Volts
Peak Repetitive Surge Current (PW = 100 $\mu$ s, 120 pps)	$I_{TSM}$	1	A
Total Power Dissipation @ $T_A = 25^\circ\text{C}$ Derate above $25^\circ\text{C}$	$P_D$	150	mW
		1.76	mW/ $^\circ\text{C}$

#### TOTAL DEVICE

Isolation Surge Voltage <sup>(1)</sup> (Peak ac Voltage, 60 Hz, 1 Second Duration)	$V_{ISO}$	7500	Vac(pk)
Total Power Dissipation @ $T_A = 25^\circ\text{C}$ Derate above $25^\circ\text{C}$	$P_D$	250	mW
		2.94	mW/ $^\circ\text{C}$
Junction Temperature Range	$T_J$	-40 to +100	$^\circ\text{C}$
Ambient Operating Temperature Range <sup>(2)</sup>	$T_A$	-40 to +85	$^\circ\text{C}$
Storage Temperature Range <sup>(2)</sup>	$T_{stg}$	-40 to +150	$^\circ\text{C}$
Soldering Temperature (10 s)	$T_L$	280	$^\circ\text{C}$

1. Isolation surge voltage,  $V_{ISO}$ , is an internal device dielectric breakdown rating.

For this test, Pins 1 and 2 are common, and Pins 4, 5 and 6 are common.

2. Refer to Quality and Reliability Section in Opto Data Book for information on test conditions.

Preferred devices are Motorola recommended choices for future use and best overall value.

(Replaces MOC3030/D)

**MOC3031**  
[IFT = 15 mA Max]  
**MOC3032**  
[IFT = 10 mA Max]  
**MOC3033\***  
[IFT = 5 mA Max]

\*Motorola Preferred Device

#### STYLE 6 PLASTIC



STANDARD THRU HOLE  
CASE 730A-04

#### COUPLER SCHEMATIC

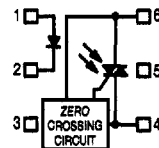

1. ANODE
2. CATHODE
3. NC
4. MAIN TERMINAL
5. SUBSTRATE  
DO NOT CONNECT
6. MAIN TERMINAL

# MOC3031 MOC3032 MOC3033

## ELECTRICAL CHARACTERISTICS ( $T_A = 25^\circ\text{C}$ unless otherwise noted)

Characteristic	Symbol	Min	Typ	Max	Unit
----------------	--------	-----	-----	-----	------

### INPUT LED

Reverse Leakage Current ( $V_R = 3\text{ V}$ )	$I_R$	—	0.05	100	$\mu\text{A}$
Forward Voltage ( $I_F = 30\text{ mA}$ )	$V_F$	—	1.3	1.5	Volts

### OUTPUT DETECTOR ( $I_F = 0$ unless otherwise noted)

Leakage with LED Off, Either Direction (Rated $V_{DRM}^{(1)}$ )	$I_{DRM1}$	—	10	100	nA
Peak On-State Voltage, Either Direction ( $I_{TM} = 100\text{ mA Peak}$ )	$V_{TM}$	—	1.8	3	Volts
Critical Rate of Rise of Off-State Voltage	$dv/dt$	1000	2000	—	$\text{V}/\mu\text{s}$

### COUPLED

LED Trigger Current, Current Required to Latch Output (Main Terminal Voltage = $3\text{ V}^{(2)}$ )	$I_{FT}$	—	—	15	mA
	MOC3031	—	—	10	
	MOC3032	—	—	5	
	MOC3033	—	—	—	
Holding Current, Either Direction	$I_H$	—	250	—	$\mu\text{A}$
Isolation Voltage ( $f = 60\text{ Hz}$ , $t = 1\text{ sec}$ )	$V_{ISO}$	7500	—	—	Vac(pk)

### ZERO CROSSING

Inhibit Voltage ( $I_F = \text{Rated } I_{FT}$ , MT1–MT2 Voltage above which device will not trigger.)	$V_{IH}$	—	5	20	Volts
Leakage in Inhibited State ( $I_F = \text{Rated } I_{FT}$ , Rated $V_{DRM}$ , Off State)	$I_{DRM2}$	—	—	500	$\mu\text{A}$

1. Test voltage must be applied within  $dv/dt$  rating.
2. All devices are guaranteed to trigger at an  $I_F$  value less than or equal to max  $I_{FT}$ . Therefore, recommended operating  $I_F$  lies between max  $I_{FT}$  (15 mA for MOC3031, 10 mA for MOC3032, 5 mA for MOC3033) and absolute max  $I_F$  (60 mA).

## TYPICAL ELECTRICAL CHARACTERISTICS

$T_A = 25^\circ\text{C}$

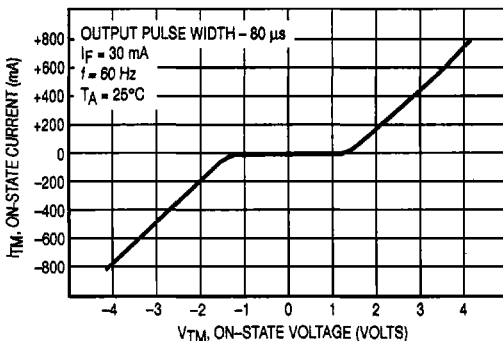

Figure 1. On-State Characteristics

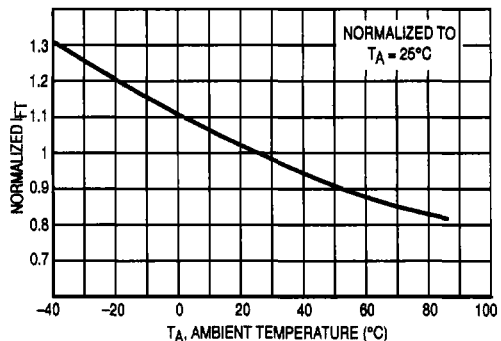

Figure 2. Trigger Current versus Temperature

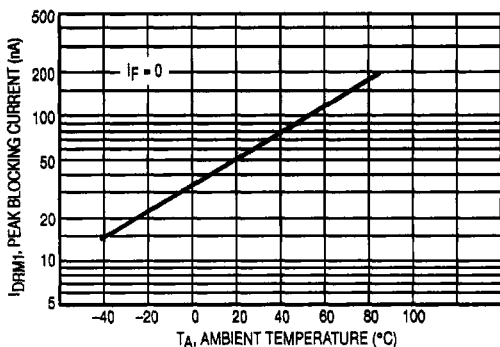

Figure 3. IDRM1, Peak Blocking Current versus Temperature

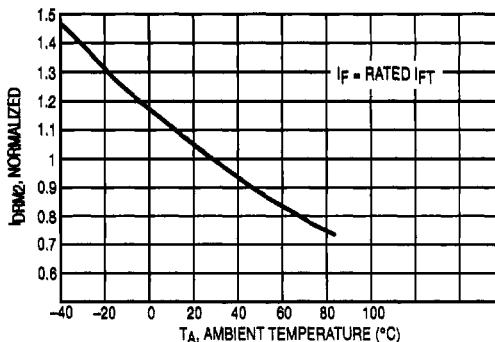

Figure 4. IDRM2, Leakage in Inhibit State versus Temperature

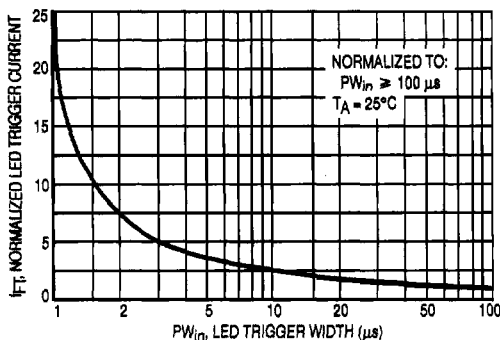
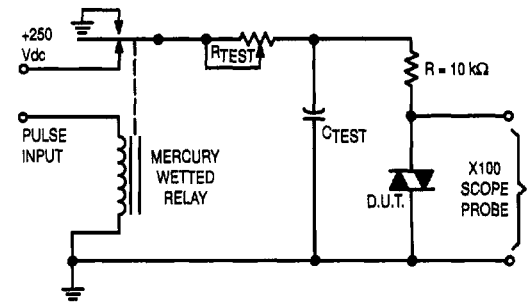

Figure 5. LED Current Required to Trigger versus LED Pulse Width



1. The mercury wetted relay provides a high speed repeated pulse to the D.U.T.
2. 100x scope probes are used, to allow high speeds and voltages.
3. The worst-case condition for static dv/dt is established by triggering the D.U.T. with a normal LED input current, then removing the current. The variable  $R_{TEST}$  allows the dv/dt to be gradually increased until the D.U.T. continues to trigger in response to the applied voltage pulse, even after the LED current has been removed. The dv/dt is then decreased until the D.U.T. stops triggering.  $\tau_{RC}$  is measured at this point and recorded.

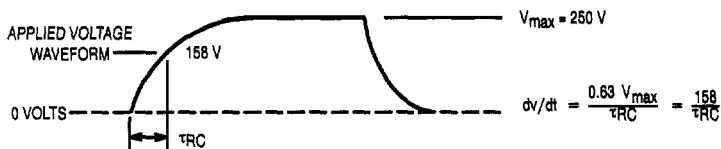
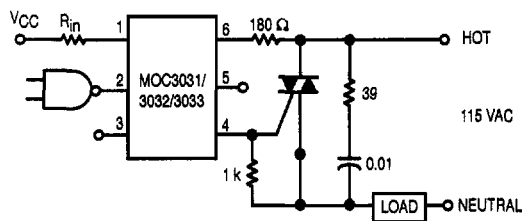

Figure 6. Static dv/dt Test Circuit

## MOC3031 MOC3032 MOC3033



\* For highly inductive loads (power factor < 0.5), change this value to 360 ohms.

Figure 7. Hot-Line Switching Application Circuit

Typical circuit for use when hot line switching is required. In this circuit the "hot" side of the line is switched and the load connected to the cold or neutral side. The load may be connected to either the neutral or hot line.

$R_{in}$  is calculated so that  $I_F$  is equal to the rated  $I_{FT}$  of the part, 5 mA for the MOC3033, 10 mA for the MOC3032, or 15 mA for the MOC3031. The 39 ohm resistor and 0.01  $\mu$ F capacitor are for snubbing of the triac and may or may not be necessary depending upon the particular triac and load used.

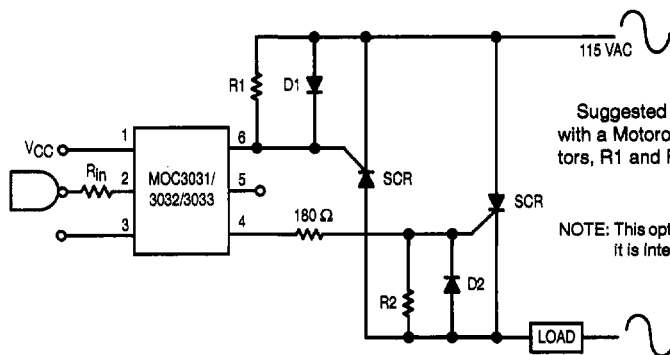

Suggested method of firing two, back-to-back SCR's, with a Motorola triac driver. Diodes can be 1N4001; resistors, R1 and R2, are optional 1 k ohm.

NOTE: This optoisolator should not be used to drive a load directly. It is intended to be a trigger device only.

Figure 8. Inverse-Parallel SCR Driver Circuit