

Description

- Six sizes of shielded drum core inductors with low profiles (as low as 1.0mm) and high power density
- Inductance range from .47uH to 1000uH
- Current range from 6.00 to 0.088 Amps
- Ferrite shielded, low EMI
- Ferrite core material



Applications

- Digital cameras, CD players, cellular phones, and PDAs
- PCMCIA cards
- GPS systems

Environmental Data

- Storage temperature range: -40°C to +125°C
- Operating ambient temperature range: -40°C to +85°C (range is application specific). Temperature rise is approximately 40°C at rated rms current
- Solder reflow temperature: +260°C max. for 10 seconds max.

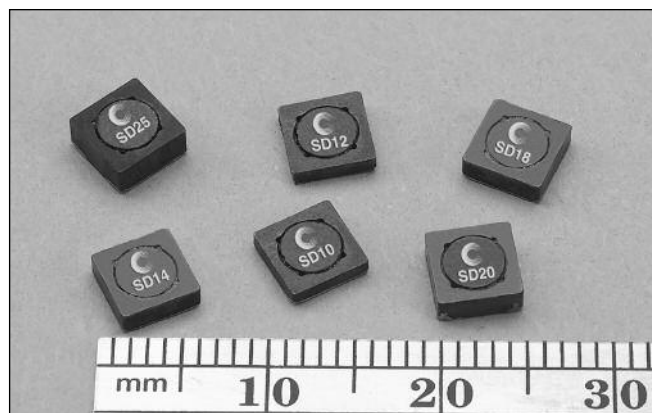

Packaging

- Supplied in tape and reel packaging, 3800 (SD10, SD12, SD14 and SD18), 2900 (SD20 and SD25) per reel

Part Number	Rated Inductance (µH)	OCL (1) +/-20% (µH)	Part Marking	Irms (2) Amperes	Isat (3) Amperes	DCR (4) (Ω) Typ.	Volt u-sec Typ.
SD10-R47-R	0.470	0.453	A	2.59	3.54	0.0249	2.1
SD10-1R0-R	1.00	1.119	B	1.93	2.25	0.0448	3.3
SD10-1R5-R	1.50	1.563	C	1.60	1.91	0.0653	3.9
SD10-2R2-R	2.20	2.081	D	1.35	1.65	0.0912	4.5
SD10-3R3-R	3.30	3.339	E	1.24	1.31	0.1078	5.7
SD10-4R7-R	4.70	4.893	F	1.04	1.08	0.1535	6.9
SD10-6R2-R	6.20	6.743	G	0.94	0.92	0.218	8.1
SD10-8R2-R	8.20	8.889	H	0.800	0.800	0.2607	9.3
SD10-100-R	10.0	10.07	J	0.760	0.752	0.336	9.9
SD10-150-R	15.0	15.55	K	0.613	0.605	0.4429	12.3
SD10-220-R	22.0	22.21	L	0.498	0.506	0.6718	14.7
SD10-330-R	33.0	32.20	M	0.412	0.420	0.9807	17.7
SD10-470-R	47.0	46.63	N	0.337	0.349	1.47	21.3
SD10-680-R	68.0	70.01	O	0.301	0.285	1.84	26.1
SD10-820-R	82.0	83.48	P	0.258	0.261	2.50	28.5
SD10-101-R	100	102.0	Q	0.225	0.236	3.29	31.5
SD10-151-R	150	149.2	R	0.200	0.195	4.15	38.1
SD10-221-R	220	222.2	S	0.161	0.160	6.41	46.5
SD10-331-R	330	330.4	T	0.130	0.131	9.83	56.7
SD10-471-R	470	468.3	U	0.117	0.110	12.10	67.5
SD12-R47-R	0.470	0.490	A	3.19	3.86	0.0246	2.84
SD12-1R2-R	1.20	1.21	B	2.62	2.45	0.0366	4.47
SD12-1R5-R	1.50	1.69	C	2.19	2.08	0.0521	5.28
SD12-2R2-R	2.20	2.25	D	1.83	1.80	0.0747	6.09
SD12-3R3-R	3.30	3.61	E	1.55	1.42	0.1043	7.71
SD12-4R7-R	4.70	4.41	F	1.46	1.29	0.1177	8.53
SD12-6R2-R	6.20	6.25	G	1.21	1.08	0.1699	10.15
SD12-8R2-R	8.20	8.41	H	1.02	0.931	0.2399	11.77
SD12-100-R	10.0	10.89	J	0.938	0.818	0.2844	13.40
SD12-150-R	15.0	15.21	K	0.782	0.692	0.4089	15.83
SD12-220-R	22.0	22.09	L	0.628	0.574	0.6338	19.08
SD12-330-R	33.0	32.49	M	0.519	0.474	0.9289	23.14
SD12-470-R	47.0	47.61	N	0.428	0.391	1.37	28.01
SD12-680-R	68.0	68.89	O	0.341	0.325	2.16	33.70

(1) Open Circuit Inductance Test Parameters: 100KHz, 0.25Vrms, 0.0Aac.
 (2) RMS current for an approximate ΔT of 40°C without core loss. It is recommended that the temperature of the part not exceed 125°C.
 (3) SD10,12,18,25 Peak current for approximate 30% roll off at 20°C.
 SD14 Peak current for approximate 20% roll off at 20°C.

(4) DCR limits @ 20°C.
 (5) Applied Volt-Time product (V-uS) across the inductor at 100kHz necessary to generate a core loss equal to 10% of the total losses for 40°C temperature rise.

Part Number	Rated Inductance (µH)	OCL (1) +/-20% (µH)	Part Marking	Irms (2) Amperes	Isat (3) Amperes	DCR (4) (Ω) Typ.	Volt u-sec Typ.
SD12-820-R	82.0	82.81	P	0.326	0.297	2.36	36.95
SD12-101-R	100	98.0	Q	0.308	0.273	2.64	40.19
SD12-151-R	150	151.3	R	0.251	0.220	3.96	49.94
SD12-221-R	220	222.0	S	0.229	0.181	4.76	60.49
SD12-331-R	330	334.9	T	0.186	0.148	7.25	74.30
SD12-471-R	470	462.3	U	0.167	0.126	8.95	87.29
SD12-681-R	680	670.8	V	0.149	0.104	11.30	105
SD12-821-R	820	800.9	W	0.129	0.095	14.93	115
SD12-102-R	1000	992.3	X	0.121	0.086	17.20	128
SD14-R58-R	0.58	0.61	A	3.52	4.84	0.0220	3.38
SD14-R87-R	0.87	0.88	B	3.2	3.96	0.0243	4.13
SD14-1R2-R	1.2	1.23	C	2.7	3.35	0.0344	4.88
SD14-1R5-R	1.5	1.63	D	2.53	2.91	0.0390	5.63
SD14-2R0-R	2	2.09	E	2.37	2.56	0.0445	6.38
SD14-2R5-R	2.5	2.62	F	2.05	2.29	0.0595	7.1
SD14-3R2-R	3.2	3.19	G	1.94	2.08	0.0663	7.9
SD14-4R5-R	4.5	4.53	H	1.64	1.74	0.0935	9.4
SD14-6R9-R	6.9	6.98	J	1.35	1.41	0.1363	11.6
SD14-8R8-R	8.8	8.88	K	1.14	1.25	0.1913	13.1
SD14-100-R	10	9.93	L	1.1	1.18	0.2058	13.9
SD14-150-R	15	14.68	M	0.98	0.969	0.2609	16.9
SD14-220-R	22	21.93	N	0.806	0.793	0.3853	20.6
SD14-330-R	33	32.55	O	0.654	0.651	0.5852	25.1
SD14-470-R	47	47.57	P	0.525	0.538	0.9055	30.4
SD14-680-R	68	68.21	Q	0.474	0.449	1.11	36
SD14-820-R	82	83	R	0.408	0.407	1.50	40
SD14-101-R	100	99.25	S	0.386	0.373	1.68	44
SD14-151-R	150	152.4	T	0.315	0.301	2.52	54
SD14-221-R	220	222	U	0.258	0.249	3.77	66
SD14-331-R	330	335.1	V	0.206	0.203	5.92	81
SD14-471-R	470	471.4	W	0.173	0.171	8.34	96
SD14-681-R	680	683.3	X	0.156	0.142	10.3	115
SD14-821-R	820	823.4	Y	0.134	0.129	13.9	126
SD14-102-R	1000	1008	Z	0.126	0.117	15.8	140
SD18-R47-R	0.47	0.49	A	3.58	4.63	0.0201	2.35
SD18-R82-R	0.82	0.81	B	3.24	3.60	0.0247	3.02
SD18-1R2-R	1.20	1.21	C	2.97	2.95	0.0294	3.70
SD18-1R5-R	1.50	1.69	D	2.73	2.49	0.0345	4.37
SD18-2R2-R	2.20	2.25	E	2.55	2.16	0.0398	5.04
SD18-3R3-R	3.30	3.61	F	2.07	1.71	0.0605	6.38
SD18-4R7-R	4.70	4.41	G	1.77	1.54	0.0824	7.06
SD18-6R2-R	6.20	6.25	H	1.61	1.30	0.1000	8.40
SD18-8R2-R	8.20	8.41	J	1.38	1.12	0.1351	9.74
SD18-100-R	10.0	10.89	K	1.28	0.982	0.1584	11.09
SD18-150-R	15.0	15.21	L	1.06	0.831	0.2278	13.10
SD18-220-R	22.0	22.09	M	0.876	0.689	0.3366	15.79
SD18-330-R	33.0	32.49	N	0.715	0.568	0.5057	19.15
SD18-470-R	47.0	47.61	O	0.578	0.470	0.7732	23.18
SD18-680-R	68.0	68.89	P	0.514	0.390	0.9798	27.89
SD18-820-R	82.0	82.81	Q	0.446	0.356	1.30	30.58
SD18-101-R	100	102.01	R	0.419	0.321	1.47	33.94
SD18-151-R	150	151.29	S	0.345	0.263	2.18	41.33
SD18-221-R	220	222.01	T	0.296	0.217	2.95	50.06
SD18-331-R	330	334.89	U	0.248	0.177	4.20	61.49
SD18-471-R	470	479.61	V	0.201	0.148	6.39	73.58
SD18-681-R	680	681.21	W	0.167	0.124	9.28	87.70
SD18-821-R	820	823.69	X	0.145	0.113	12.35	96.43
SD18-102-R	1000	1004	Y	0.136	0.102	14.01	107

(1) Open Circuit Inductance Test Parameters: 100KHz, 0.25Vrms, 0.0Adc.
(2) RMS current for an approximate ΔT of 40°C without core loss. It is recommended that the temperature of the part not exceed 125°C.
(3) SD10,12,18,25 Peak current for approximate 30% roll off at 20°C.
SD14 Peak current for approximate 20% roll off at 20°C.

(4) DCR limits @ 20°C.
(5) Applied Volt-Time product (V-uS) across the inductor at 100kHz necessary to generate a core loss equal to 10% of the total losses for 40°C temperature rise.

Part Number	Rated Inductance (µH)	OCL (1) +/-20% (µH)	Part Marking	I _{rms} (2) Amperes	I _{sat} (3) Amperes	DCR (4) (Ω) Typ.	Volt u-sec Typ.
SD20-R47-R	0.47	0.490	A	3.59	4.00	0.0200	2.28
SD20-1R2-R	1.20	1.21	B	3.07	2.55	0.0275	3.58
SD20-1R5-R	1.50	1.69	C	2.88	2.15	0.0312	4.23
SD20-2R2-R	2.20	2.25	D	2.45	1.87	0.0429	4.88
SD20-3R3-R	3.30	3.61	E	2.17	1.47	0.0547	6.18
SD20-4R7-R	4.70	4.41	F	2.05	1.33	0.0612	6.83
SD20-6R2-R	6.20	6.25	G	1.89	1.12	0.0720	8.13
SD20-8R2-R	8.20	8.41	H	1.61	0.966	0.1000	9.43
SD20-100-R	10.0	9.61	J	1.53	0.903	0.1100	10.08
SD20-150-R	15.0	15.21	K	1.25	0.718	0.1655	12.68
SD20-220-R	22.0	22.09	L	1.12	0.596	0.2053	15.28
SD20-330-R	33.0	32.49	M	0.913	0.491	0.3100	18.53
SD20-470-R	47.0	47.61	N	0.745	0.406	0.4650	22.43
SD20-680-R	68.0	68.89	O	0.610	0.337	0.6947	26.98
SD20-820-R	82.0	82.81	P	0.576	0.308	0.7785	29.58
SD20-101-R	100	98.01	Q	0.495	0.283	1.06	32.18
SD20-151-R	150	151.3	R	0.435	0.228	1.37	39.98
SD20-221-R	220	222.0	S	0.356	0.188	2.04	48.43
SD20-331-R	330	327.6	T	0.294	0.155	2.99	58.83
SD20-471-R	470	470.9	U	0.263	0.129	3.74	70.53
SD20-681-R	680	681.2	V	0.216	0.107	5.56	84.83
SD20-821-R	820	823.7	W	0.204	0.098	6.22	93.28
SD20-102-R	1000	1004.9	X	0.172	0.088	8.73	103
SD25-R47-R	0.47	0.466	A	3.88	6.00	0.0177	2.13
SD25-R82-R	0.82	0.770	B	3.58	4.67	0.0208	2.74
SD25-1R2-R	1.20	1.15	C	3.33	3.81	0.0240	3.34
SD25-1R5-R	1.50	1.61	D	3.12	3.23	0.0274	3.95
SD25-2R2-R	2.20	2.14	E	2.93	2.80	0.0311	4.56
SD25-3R3-R	3.30	3.43	F	2.64	2.21	0.0384	5.78
SD25-4R7-R	4.70	5.03	G	2.39	1.83	0.0467	6.99
SD25-6R8-R	6.80	6.93	H	2.19	1.56	0.0556	8.21
SD25-8R2-R	8.20	7.99	J	1.92	1.45	0.0724	8.82
SD25-100-R	10.0	10.35	K	1.80	1.27	0.0824	10.03
SD25-150-R	15.0	14.45	L	1.67	1.08	0.0956	11.86
SD25-220-R	22.0	22.81	M	1.34	0.857	0.1478	14.90
SD25-330-R	33.0	33.07	N	1.11	0.711	0.2149	17.94
SD25-470-R	47.0	47.89	O	0.919	0.592	0.3156	21.58
SD25-680-R	68.0	68.64	P	0.741	0.482	0.4850	25.84
SD25-820-R	82.0	82.17	Q	0.713	0.441	0.5242	28.27
SD25-101-R	100	100.79	R	0.670	0.398	0.5937	31.31
SD25-151-R	150	148.4	S	0.553	0.328	0.8723	38.00
SD25-221-R	220	222.4	T	0.446	0.268	1.34	46.51
SD25-331-R	330	332.2	U	0.359	0.219	2.07	56.85
SD25-471-R	470	472.4	V	0.293	0.184	3.10	67.79
SD25-681-R	680	677.2	W	0.262	0.154	3.88	81.17
SD25-821-R	820	826.7	X	0.230	0.139	5.04	89.68
SD25-102-R	1000	1003.4	Y	0.216	0.126	5.70	98.80

- (1) Open Circuit Inductance Test Parameters: 100KHz, 0.25V_{rms}, 0.0Adc.
 (2) RMS current for an approximate ΔT of 40°C without core loss. It is recommended that the temperature of the part not exceed 125°C.
 (3) SD10,12,18,25 Peak current for approximate 30% roll off at 20°C.
 SD14 Peak current for approximate 20% roll off at 20°C.

- (4) DCR limits @ 20°C.
 (5) Applied Volt-Time product (V-uS) across the inductor at 100KHz necessary to generate a core loss equal to 10% of the total losses for 40°C temperature rise.

Mechanical Diagrams

SD Series

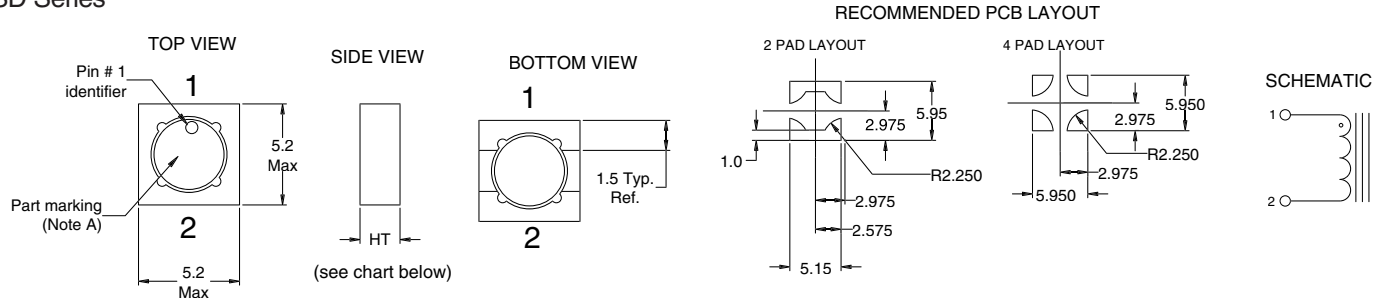

Series	HT
SD10	1.0mm max
SD12	1.2mm max
SD14	1.45mm max
SD18	1.8mm max
SD20	2.0mm max
SD25	2.5mm max

A) Part Marking: Line 1: (1st digit indicates the inductance value per part marking designator in chart above)
 (2nd digit is a bi-weekly production date code)
 (3rd digit is the last digit of the year produced)
 Line 2: XX (indicates the product size code)

Packaging Information

SD10 Series

Ao=5.45mm
 Bo=5.45mm
 Ko=1.20mm

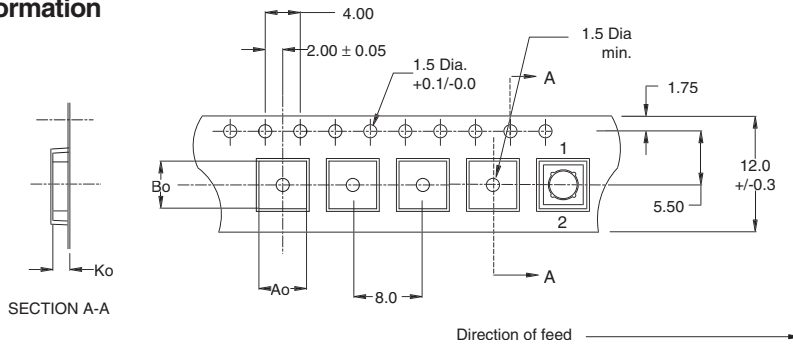

ACTUAL SIZE
SD10

Parts packaged on 13" Diameter reel,
3,800 parts per reel.

SD12/14/18 Series

Ao=5.45mm
 Bo=5.45mm
 Ko=2.00mm

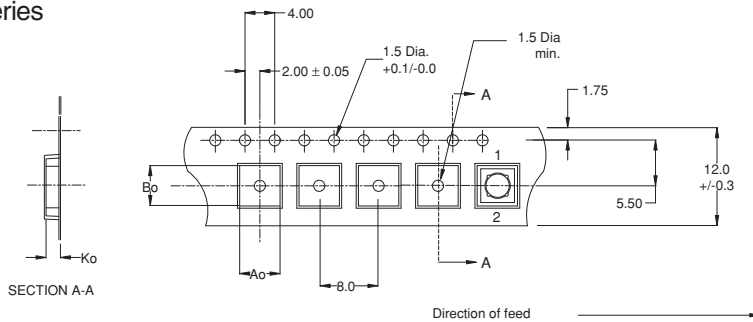

ACTUAL SIZE
SD12

ACTUAL SIZE
SD14

ACTUAL SIZE
SD18

Parts packaged on 13" Diameter reel,
3,800 parts per reel.

SD20/25 Series

Ao=5.45mm
 Bo=5.45mm
 Ko=2.70mm

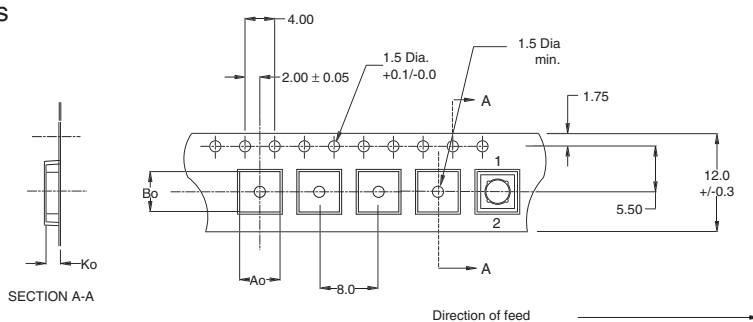

ACTUAL SIZE
SD20

ACTUAL SIZE
SD25

Parts packaged on 13" Diameter reel,
2,900 parts per reel.

Dimensions are in millimeters.

DC Current vs. Temperature

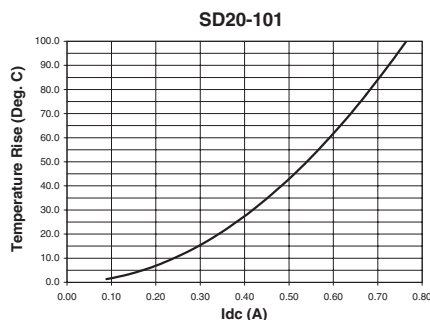
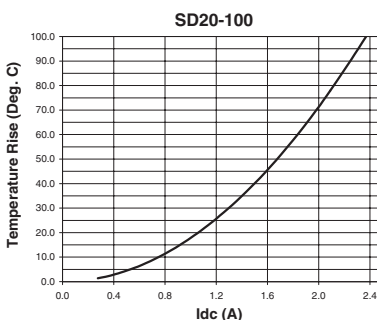
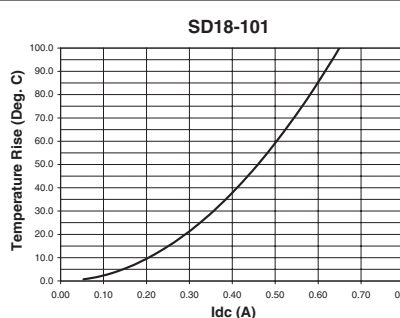
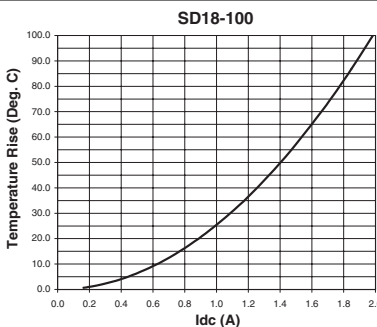
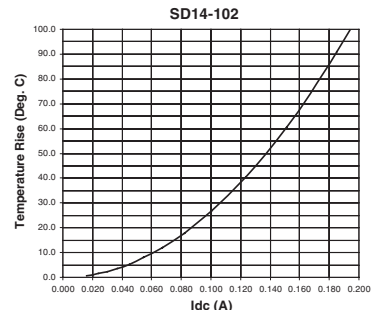
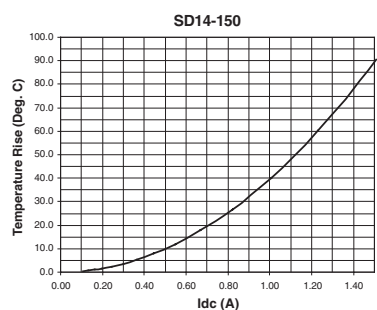
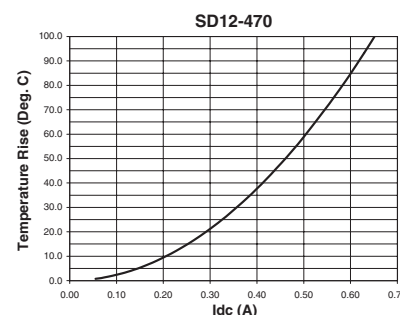
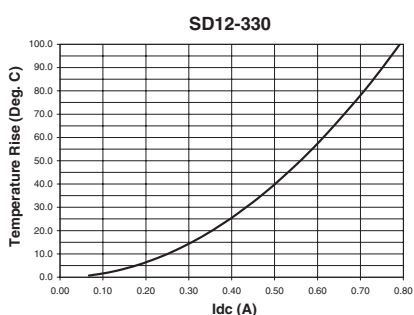
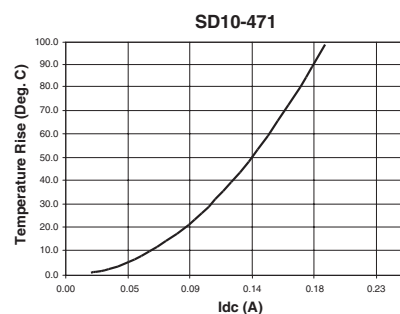
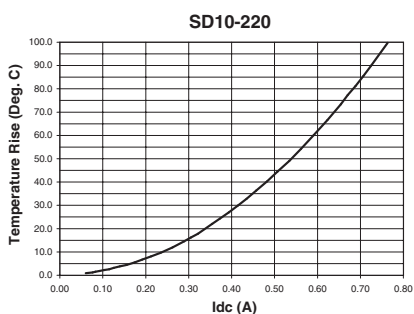

DC Current vs. Temperature

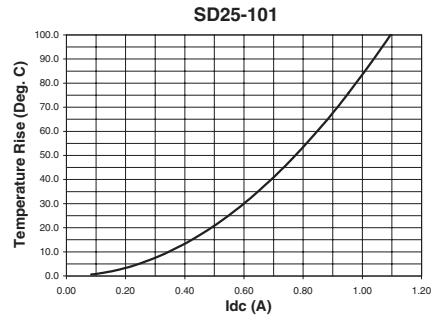
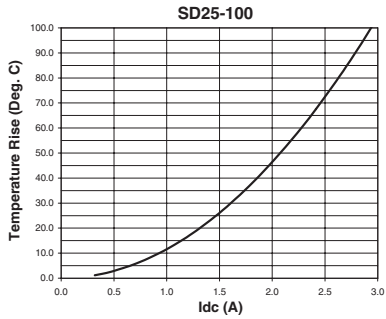

Inductance Characteristics

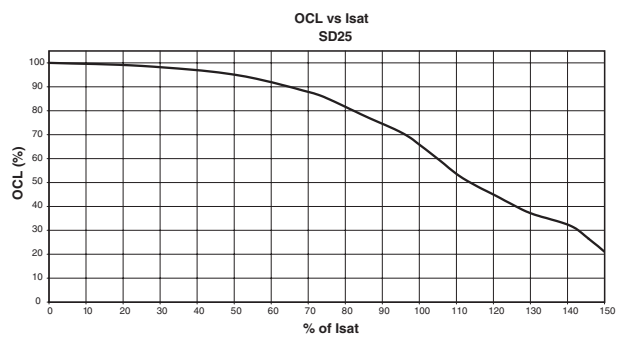
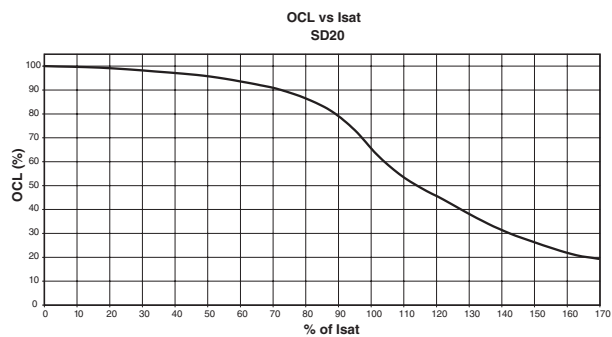
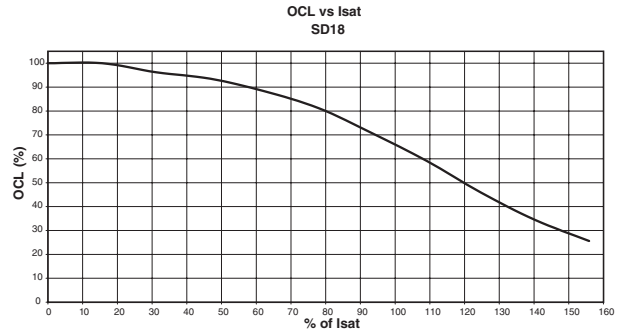
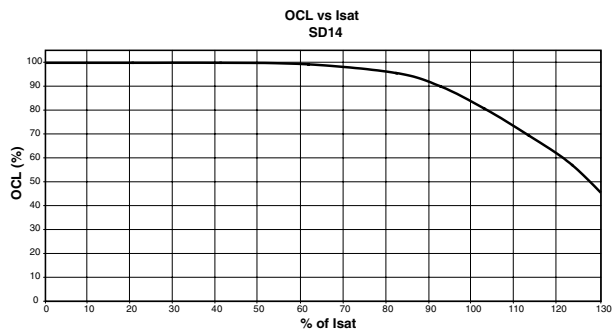
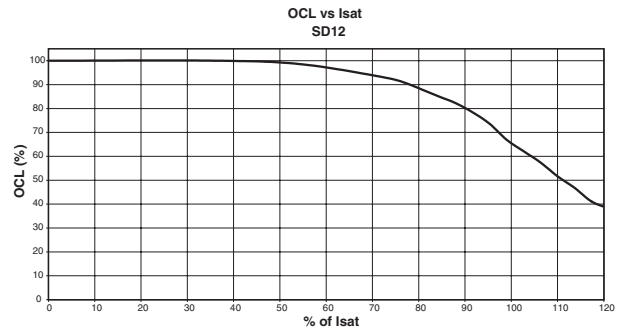
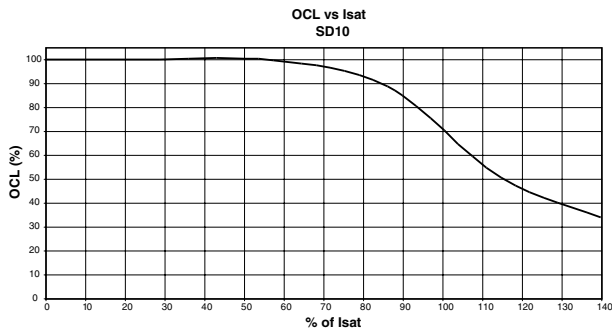

Core Loss

