

# DATA SHEET

## **BTA225 series B** Three quadrant triacs high commutation

Product specification

September 1997



# Three quadrant triacs high commutation

## BTA225 series B

### GENERAL DESCRIPTION

Glass passivated high commutation triacs in a plastic envelope intended for use in circuits where high static and dynamic dV/dt and high dI/dt can occur loads. These devices will commutate the full rated rms current at the maximum rated junction temperature, without the aid of a snubber.

### QUICK REFERENCE DATA

SYMBOL	PARAMETER	MAX.	MAX.	MAX.	UNIT
$V_{DRM}$	Repetitive peak off-state voltages	<b>500B</b> 500	<b>600B</b> 600	<b>800B</b> 800	V
$I_{T(RMS)}$	RMS on-state current	25	25	25	A
$I_{TSM}$	Non-repetitive peak on-state current	190	190	190	A

### PINNING - TO220AB

PIN	DESCRIPTION
1	main terminal 1
2	main terminal 2
3	gate
tab	main terminal 2

### PIN CONFIGURATION

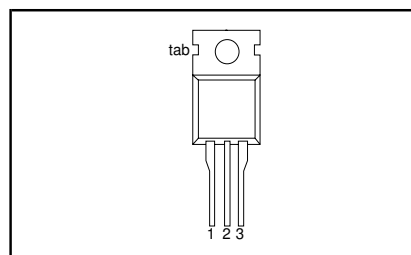

### SYMBOL

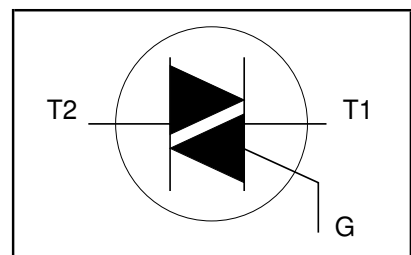

### LIMITING VALUES

Limiting values in accordance with the Absolute Maximum System (IEC 134).

SYMBOL	PARAMETER	CONDITIONS	MIN.	MAX.			UNIT
				-500	-600	-800	
$V_{DRM}$	Repetitive peak off-state voltages		-	600 <sup>1</sup>	600 <sup>1</sup>	800	V
$I_{T(RMS)}$	RMS on-state current	full sine wave; $T_{mb} \leq 91\text{ °C}$	-	25			A
$I_{TSM}$	Non-repetitive peak on-state current	full sine wave; $T_j = 25\text{ °C}$ prior to surge	-	190			A
$I^2t$	$I^2t$ for fusing	$t = 20\text{ ms}$	-	209			A
$dl_T/dt$	Repetitive rate of rise of on-state current after triggering	$t = 10\text{ ms}$ $I_{TM} = 30\text{ A}; I_G = 0.2\text{ A}; dl_G/dt = 0.2\text{ A}/\mu\text{s}$	-	180			A <sup>2</sup> s
$I_{GM}$	Peak gate current		-	2			A
$V_{GM}$	Peak gate voltage		-	5			V
$P_{GM}$	Peak gate power		-	5			W
$P_{G(AV)}$	Average gate power	over any 20 ms period	-	0.5			W
$T_{stg}$	Storage temperature		-40	150			°C
$T_j$	Operating junction temperature		-	125			°C

<sup>1</sup> Although not recommended, off-state voltages up to 800V may be applied without damage, but the triac may switch to the on-state. The rate of rise of current should not exceed 15 A/μs.

## Three quadrant triacs high commutation

## BTA225 series B

### THERMAL RESISTANCES

SYMBOL	PARAMETER	CONDITIONS	MIN.	TYP.	MAX.	UNIT
$R_{th\ j-mb}$	Thermal resistance junction to mounting base	full cycle	-	-	1.0	K/W
		half cycle	-	-	1.4	K/W
$R_{th\ j-a}$	Thermal resistance junction to ambient	in free air	-	60	-	K/W

### STATIC CHARACTERISTICS

$T_j = 25\text{ °C}$  unless otherwise stated

SYMBOL	PARAMETER	CONDITIONS	MIN.	TYP.	MAX.	UNIT
$I_{GT}$	Gate trigger current <sup>2</sup>	$V_D = 12\text{ V}; I_T = 0.1\text{ A}$				
		T2+ G+	2	18	50	mA
		T2+ G-	2	21	50	mA
		T2- G-	2	34	50	mA
$I_L$	Latching current	$V_D = 12\text{ V}; I_{GT} = 0.1\text{ A}$				
		T2+ G+	-	31	60	mA
		T2+ G-	-	34	90	mA
		T2- G-	-	30	60	mA
$I_H$	Holding current	$V_D = 12\text{ V}; I_{GT} = 0.1\text{ A}$	-	31	60	mA
$V_T$	On-state voltage	$I_T = 30\text{ A}$	-	1.3	1.55	V
$V_{GT}$	Gate trigger voltage	$V_D = 12\text{ V}; I_T = 0.1\text{ A}$	-	0.7	1.5	V
		$V_D = 400\text{ V}; I_T = 0.1\text{ A}; T_j = 125\text{ °C}$	0.25	0.4	-	V
$I_D$	Off-state leakage current	$V_D = V_{DRM(max)}; T_j = 125\text{ °C}$	-	0.1	0.5	mA

### DYNAMIC CHARACTERISTICS

$T_j = 25\text{ °C}$  unless otherwise stated

SYMBOL	PARAMETER	CONDITIONS	MIN.	TYP.	MAX.	UNIT
$dV_D/dt$	Critical rate of rise of off-state voltage	$V_{DM} = 67\% V_{DRM(max)}; T_j = 125\text{ °C};$ exponential waveform; gate open circuit	1000	4000	-	V/ $\mu$ s
$di_{com}/dt$	Critical rate of change of commutating current	$V_{DM} = 400\text{ V}; T_j = 125\text{ °C}; I_{T(RMS)} = 25\text{ A};$ without snubber; gate open circuit	-	44	-	A/ms
$t_{gt}$	Gate controlled turn-on time	$I_{TM} = 30\text{ A}; V_D = V_{DRM(max)}; I_G = 0.1\text{ A};$ $di_G/dt = 5\text{ A}/\mu$ s	-	2	-	$\mu$ s

<sup>2</sup> Device does not trigger in the T2-, G+ quadrant.

# Three quadrant triacs high commutation

## BTA225 series B

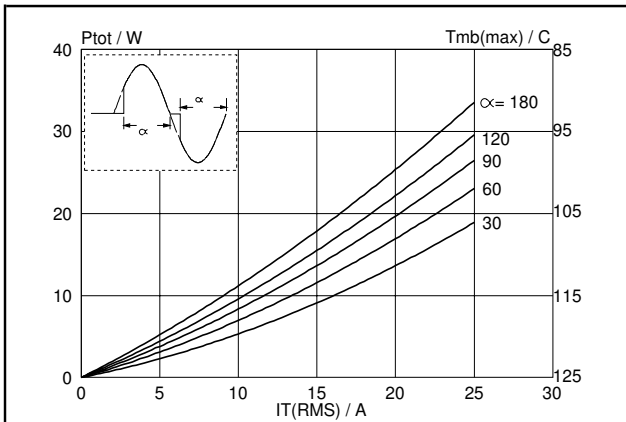

Fig.1. Maximum on-state dissipation,  $P_{tot}$ , versus rms on-state current,  $I_{T(RMS)}$ , where  $\alpha =$  conduction angle.

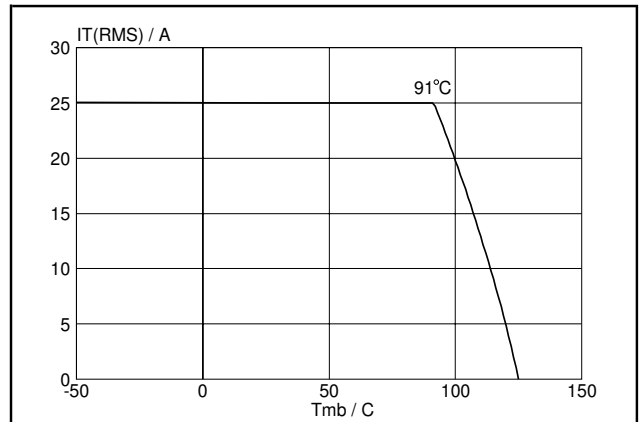

Fig.4. Maximum permissible rms current  $I_{T(RMS)}$ , versus mounting base temperature  $T_{mb}$ .

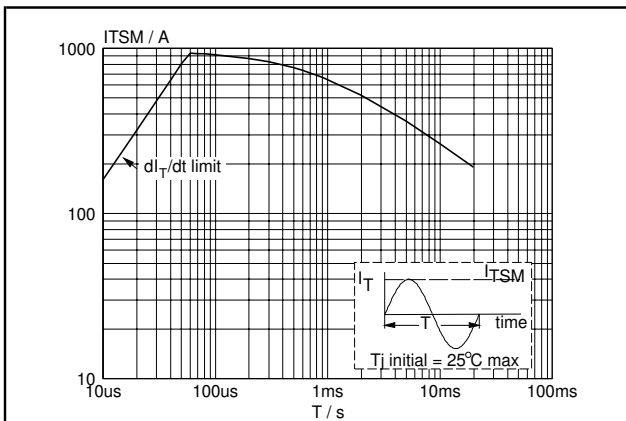

Fig.2. Maximum permissible non-repetitive peak on-state current  $I_{TSM}$ , versus pulse width  $t_p$ , for sinusoidal currents,  $t_p \leq 20ms$ .

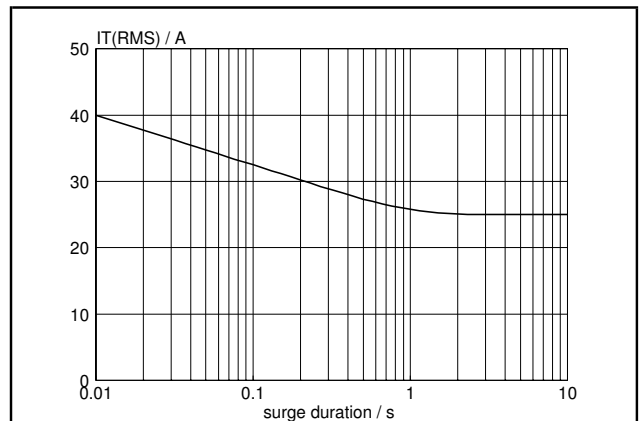

Fig.5. Maximum permissible repetitive rms on-state current  $I_{T(RMS)}$ , versus surge duration, for sinusoidal currents,  $f = 50$  Hz;  $T_{mb} \leq 91^\circ\text{C}$ .

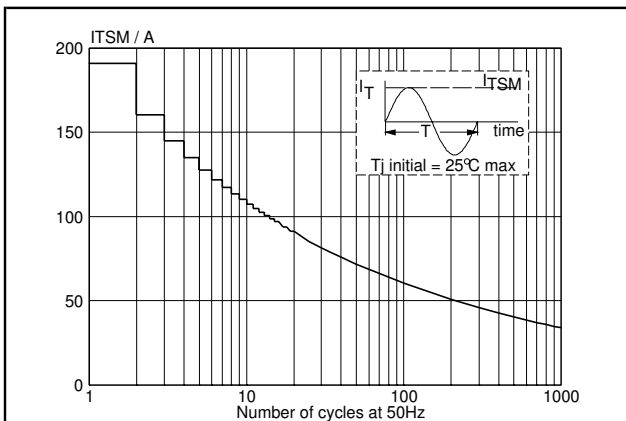

Fig.3. Maximum permissible non-repetitive peak on-state current  $I_{TSM}$ , versus number of cycles, for sinusoidal currents,  $f = 50$  Hz.

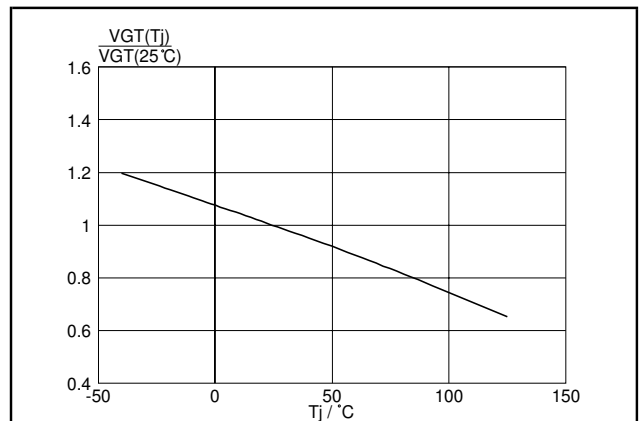
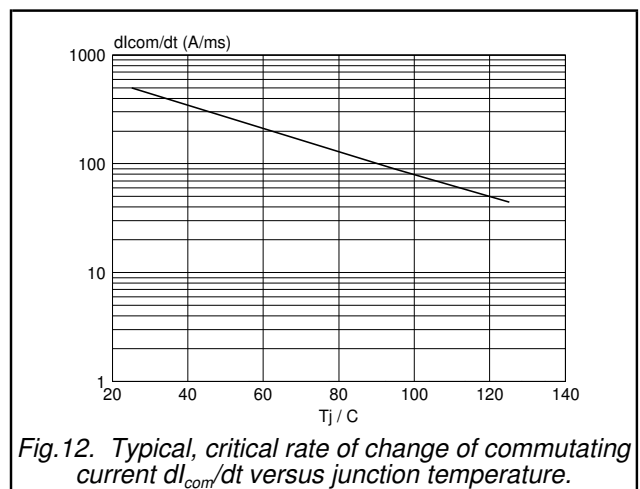
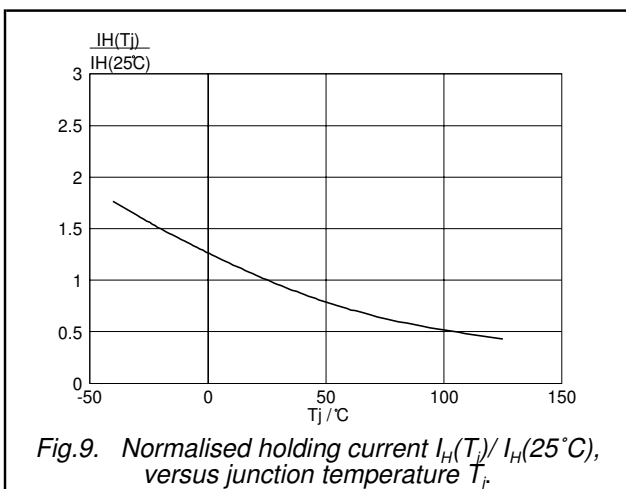
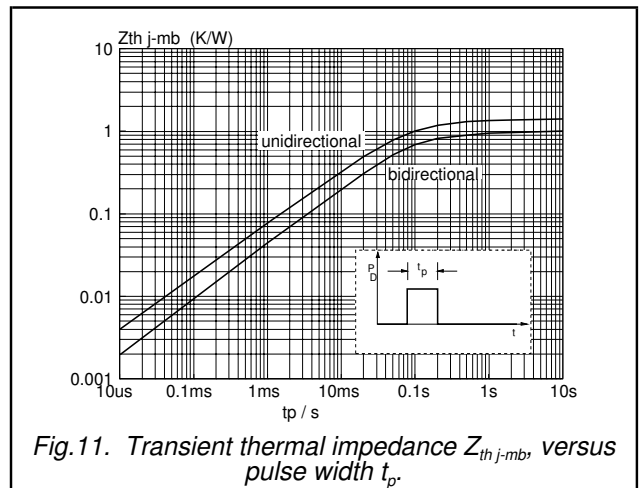
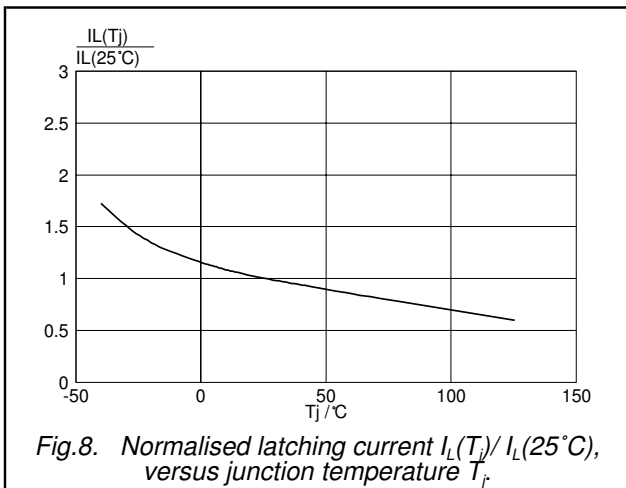
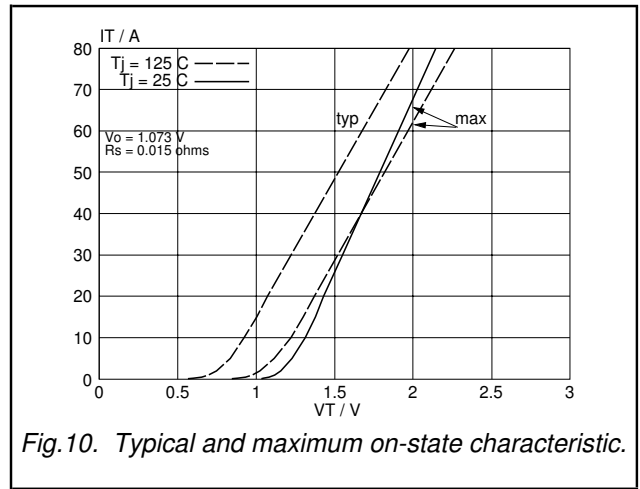
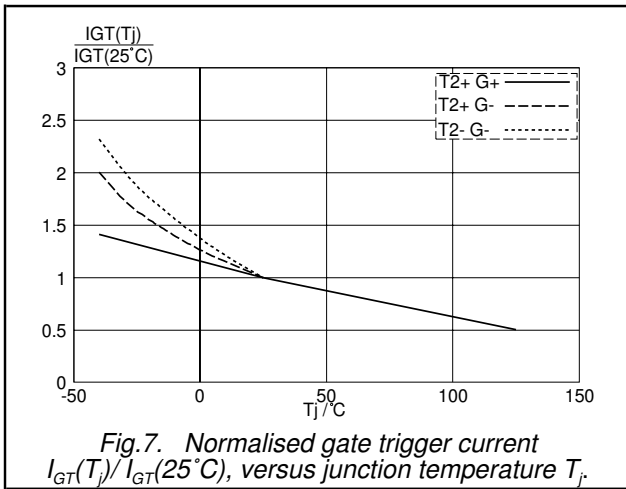

Fig.6. Normalised gate trigger voltage  $V_{GT}(T_j)/V_{GT}(25^\circ\text{C})$ , versus junction temperature  $T_j$ .

Three quadrant triacs  
high commutation

BTA225 series B



Three quadrant triacs  
high commutation

BTA225 series B

**MECHANICAL DATA**

*Dimensions in mm*

*Net Mass: 2 g*

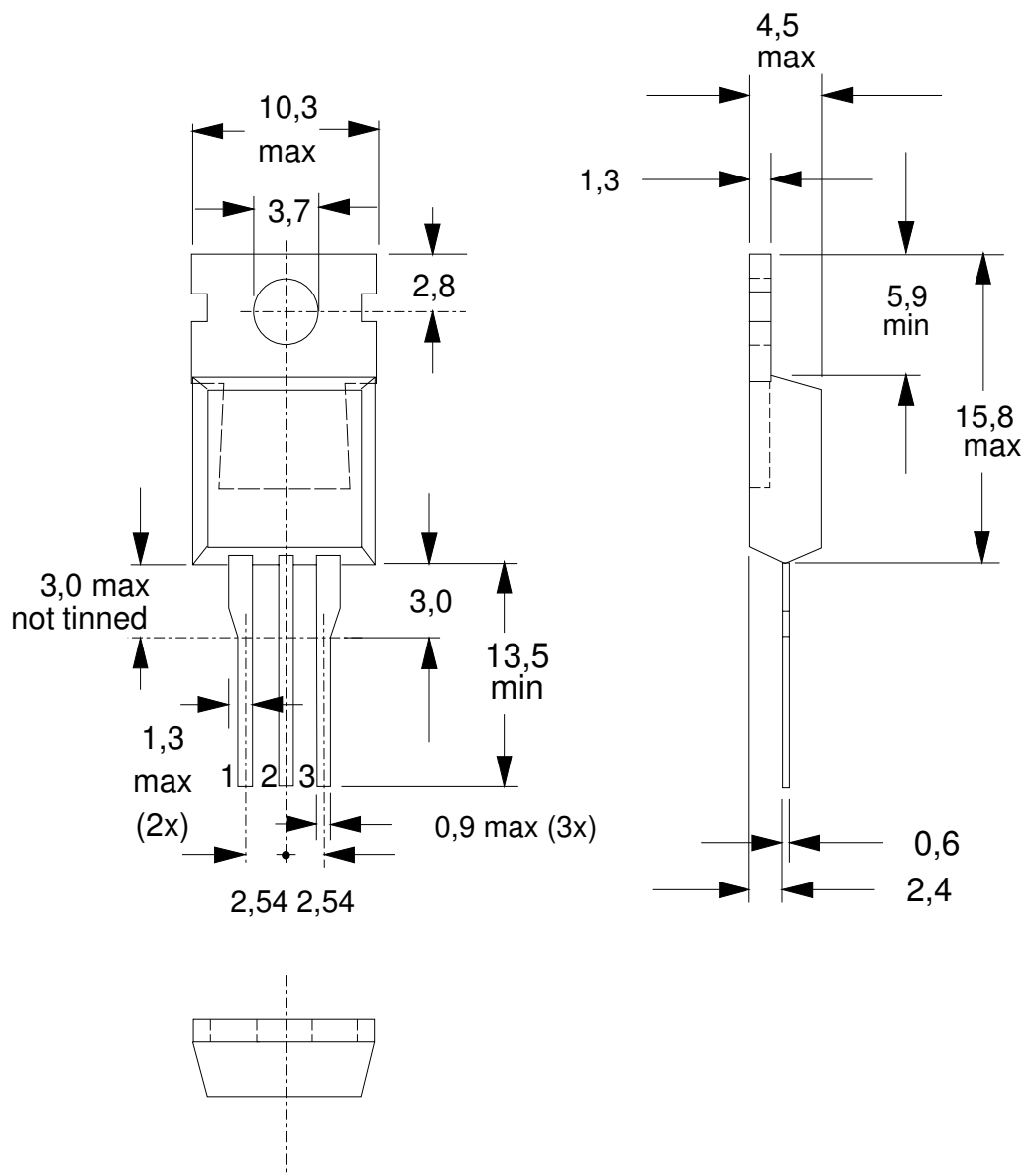

Fig.13. TO220AB; pin 2 connected to mounting base.

**Notes**

1. Refer to mounting instructions for TO220 envelopes.
2. Epoxy meets UL94 V0 at 1/8".

## Legal information

### DATA SHEET STATUS

DOCUMENT STATUS <sup>(1)</sup>	PRODUCT STATUS <sup>(2)</sup>	DEFINITION
Objective data sheet	Development	This document contains data from the objective specification for product development.
Preliminary data sheet	Qualification	This document contains data from the preliminary specification.
Product data sheet	Production	This document contains the product specification.

### Notes

1. Please consult the most recently issued document before initiating or completing a design.
2. The product status of device(s) described in this document may have changed since this document was published and may differ in case of multiple devices. The latest product status information is available on the Internet at URL <http://www.nxp.com>.

### DEFINITIONS

**Product specification** — The information and data provided in a Product data sheet shall define the specification of the product as agreed between NXP Semiconductors and its customer, unless NXP Semiconductors and customer have explicitly agreed otherwise in writing. In no event however, shall an agreement be valid in which the NXP Semiconductors product is deemed to offer functions and qualities beyond those described in the Product data sheet.

### DISCLAIMERS

**Limited warranty and liability** — Information in this document is believed to be accurate and reliable. However, NXP Semiconductors does not give any representations or warranties, expressed or implied, as to the accuracy or completeness of such information and shall have no liability for the consequences of use of such information.

In no event shall NXP Semiconductors be liable for any indirect, incidental, punitive, special or consequential damages (including - without limitation - lost profits, lost savings, business interruption, costs related to the removal or replacement of any products or rework charges) whether or not such damages are based on tort (including negligence), warranty, breach of contract or any other legal theory.

Notwithstanding any damages that customer might incur for any reason whatsoever, NXP Semiconductors' aggregate and cumulative liability towards customer for the products described herein shall be limited in accordance with the *Terms and conditions of commercial sale* of NXP Semiconductors.

**Right to make changes** — NXP Semiconductors reserves the right to make changes to information published in this document, including without limitation specifications and product descriptions, at any time and without notice. This document supersedes and replaces all information supplied prior to the publication hereof.

**Suitability for use** — NXP Semiconductors products are not designed, authorized or warranted to be suitable for use in life support, life-critical or safety-critical systems or equipment, nor in applications where failure or malfunction of an NXP Semiconductors product can reasonably be expected to result in personal injury, death or severe property or environmental damage. NXP Semiconductors accepts no liability for inclusion and/or use of NXP Semiconductors products in such equipment or applications and therefore such inclusion and/or use is at the customer's own risk.

**Applications** — Applications that are described herein for any of these products are for illustrative purposes only. NXP Semiconductors makes no representation or warranty that such applications will be suitable for the specified use without further testing or modification.

Customers are responsible for the design and operation of their applications and products using NXP Semiconductors products, and NXP Semiconductors accepts no liability for any assistance with applications or customer product design. It is customer's sole responsibility to determine whether the NXP Semiconductors product is suitable and fit for the customer's applications and products planned, as well as for the planned application and use of customer's third party customer(s). Customers should provide appropriate design and operating safeguards to minimize the risks associated with their applications and products.

## Legal information

---

NXP Semiconductors does not accept any liability related to any default, damage, costs or problem which is based on any weakness or default in the customer's applications or products, or the application or use by customer's third party customer(s). Customer is responsible for doing all necessary testing for the customer's applications and products using NXP Semiconductors products in order to avoid a default of the applications and the products or of the application or use by customer's third party customer(s). NXP does not accept any liability in this respect.

**Limiting values** — Stress above one or more limiting values (as defined in the Absolute Maximum Ratings System of IEC 60134) will cause permanent damage to the device. Limiting values are stress ratings only and (proper) operation of the device at these or any other conditions above those given in the Recommended operating conditions section (if present) or the Characteristics sections of this document is not warranted. Constant or repeated exposure to limiting values will permanently and irreversibly affect the quality and reliability of the device.

**Terms and conditions of commercial sale** — NXP Semiconductors products are sold subject to the general terms and conditions of commercial sale, as published at <http://www.nxp.com/profile/terms>, unless otherwise agreed in a valid written individual agreement. In case an individual agreement is concluded only the terms and conditions of the respective agreement shall apply. NXP Semiconductors hereby expressly objects to applying the customer's general terms and conditions with regard to the purchase of NXP Semiconductors products by customer.

**No offer to sell or license** — Nothing in this document may be interpreted or construed as an offer to sell products

that is open for acceptance or the grant, conveyance or implication of any license under any copyrights, patents or other industrial or intellectual property rights.

**Export control** — This document as well as the item(s) described herein may be subject to export control regulations. Export might require a prior authorization from national authorities.

**Quick reference data** — The Quick reference data is an extract of the product data given in the Limiting values and Characteristics sections of this document, and as such is not complete, exhaustive or legally binding.

**Non-automotive qualified products** — Unless this data sheet expressly states that this specific NXP Semiconductors product is automotive qualified, the product is not suitable for automotive use. It is neither qualified nor tested in accordance with automotive testing or application requirements. NXP Semiconductors accepts no liability for inclusion and/or use of non-automotive qualified products in automotive equipment or applications.

In the event that customer uses the product for design-in and use in automotive applications to automotive specifications and standards, customer (a) shall use the product without NXP Semiconductors' warranty of the product for such automotive applications, use and specifications, and (b) whenever customer uses the product for automotive applications beyond NXP Semiconductors' specifications such use shall be solely at customer's own risk, and (c) customer fully indemnifies NXP Semiconductors for any liability, damages or failed product claims resulting from customer design and use of the product for automotive applications beyond NXP Semiconductors' standard warranty and NXP Semiconductors' product specifications.

### Customer notification

This data sheet was changed to reflect the new company name NXP Semiconductors, including new legal definitions and disclaimers. No changes were made to the content, except for the legal definitions and disclaimers.

### Contact information

For additional information please visit: <http://www.nxp.com>

For sales offices addresses send e-mail to: [salesaddresses@nxp.com](mailto:salesaddresses@nxp.com)

© NXP B.V. 2011

All rights are reserved. Reproduction in whole or in part is prohibited without the prior written consent of the copyright owner.

The information presented in this document does not form part of any quotation or contract, is believed to be accurate and reliable and may be changed without notice. No liability will be accepted by the publisher for any consequence of its use. Publication thereof does not convey nor imply any license under patent- or other industrial or intellectual property rights.

Printed in The Netherlands