

# 1000BASE-T MAGNETICS MODULE

Designed to Support 1:1 Turns Ratio Transceivers

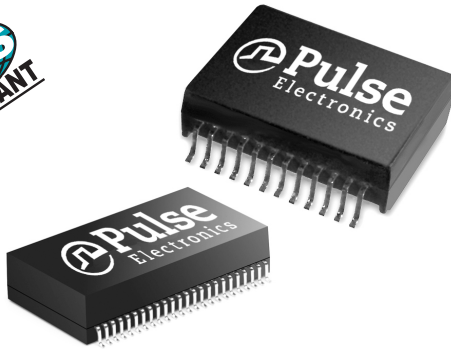
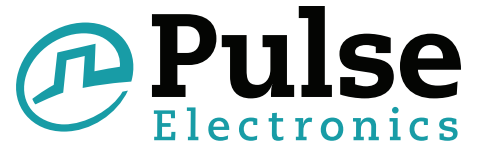

- RoHS peak reflow temperature rating 245°C
- Meets IEEE 802.3 specification

## Electrical Specifications @ 25°C — Operating Temperature 0°C to 70°C

RoHS Compliant Part Number	Number of Ports	Insertion Loss (dB MAX)	Return Loss (dB MIN)					Differential to Common Mode Rejection (dB MIN)			Crosstalk (dB MIN)			Hipot (Vrms)
			1-100 MHz	1-30 MHz	40 MHz	50 MHz	60-80 MHz	100 MHz	30 MHz	60 MHz	100 MHz	30 MHz	60 MHz	
H5004NL 3d	1	1	-18	-18	-16	-12	-10	-43	-37	-33	-43	-37	-33	1500
HX5004NL 1, 3d	1	1	-18	-18	-16	-12	-10	-43	-37	-33	-43	-37	-33	1500
H5007NL 3d	1	1	-18	-18	-16	-12	-10	-43	-37	-33	-43	-37	-33	1500
H5008NL 3a, 4	1	1	-18	-18	-16	-12	-10	-43	-37	-33	-43	-37	-33	1500
HX5008NL 1, 3a, 4	1	1	-18	-18	-16	-12	-10	-43	-37	-33	-43	-37	-33	1500
H5009NL 3a, 4	1	1	-18	-18	-16	-12	-10	-43	-37	-33	-43	-37	-33	1500
H5012NL 3a, 4	2	1.4	-18	-16	-14.4	-12	-10	-45	-40	-35	-43.5	-37.5	-33	1500
H5014NL 3a, 4	2	1.4	-18	-16	-14.4	-12	-10	-45	-40	-35	-43.5	-37.5	-33	1500
HX5014NL 1, 3a, 4	2	1.4	-18	-16	-14.4	-12	-10	-45	-40	-35	-43.5	-37.5	-33	1500
H5015NL 3a, 4	1	1	-18	-18	-16	-12	-10	-43	-37	-33	-43	-37	-33	1500
H5020NL 3a, 4	2	1	-18	-16	-14.4	-12	-10	-40	-35	-30	-40	-33	-28	1500
HX5020NL 1, 3a, 4	2	1.4	-18	-16	-14.4	-12	-10	-40	-35	-30	-40	-33	-28	1500
H5089NL 3a, 4	2	1.4	-18	-16	-14.4	-12	-10	-45	-40	-35	-43.5	-37.5	-33	1500

- HX = extended temperature version -40°C to +85°C
- For Tape & Reel packaging, add a "T" suffix at the end of the part number, e.g. H5007NLT.
- MSL = Moisture Sensitivity Level: a = 1, b = 2, c = 3, d = 4
- Not for sale in the U.S.

## Mechanicals

### H5004NL, HX5004NL\*, H5007NL\*

H5004NL, H5007NL, and HX5004NL are footprint-compatible to 10/100BASE-TX part H1267.

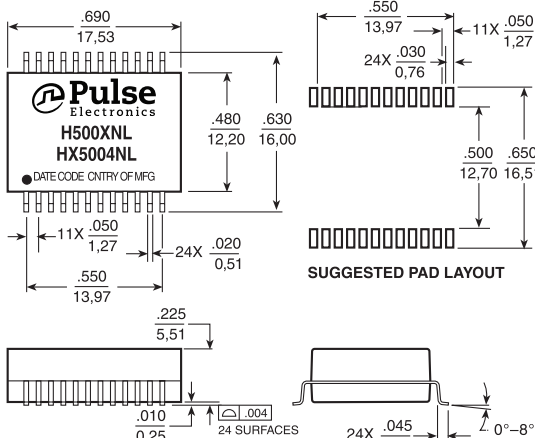

### H5008NL, H5009NL, HX5008NL, H5089NL

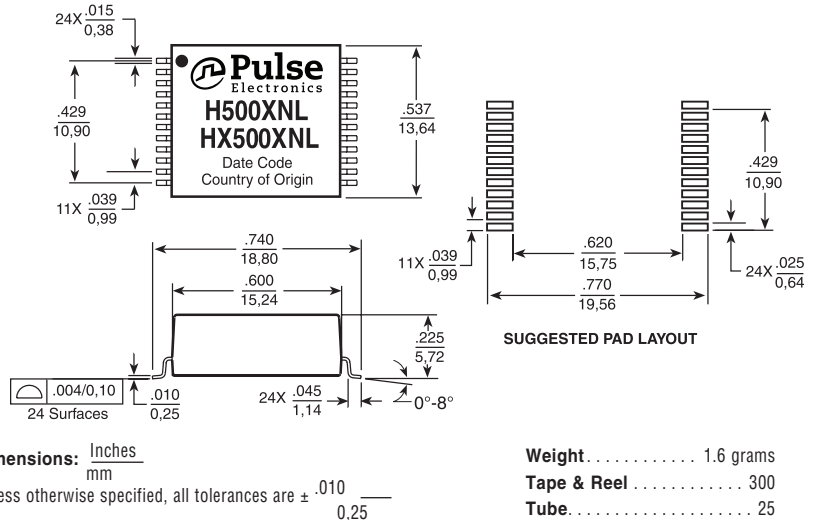

# 1000BASE-T MAGNETICS MODULE

Designed to Support 1:1 Turns Ratio Transceivers

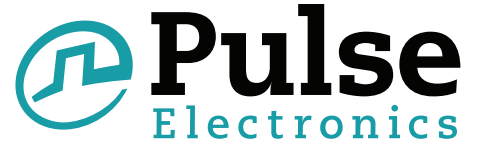

## Mechanicals (continued)

### H5012NL, H5014NL, HX5014NL, H5089NL

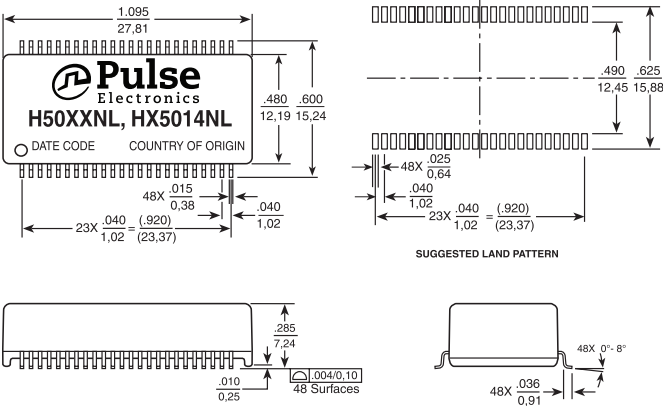

Weight . . . . . 4.0 grams  
 Tape & Reel . . . . . 250/reel  
 Tube . . . . . 15/tube

Dimensions: Inches \_\_\_\_\_  
 mm \_\_\_\_\_  
 Unless otherwise specified, all tolerances are  $\pm \frac{.005}{0,13}$

### H5020NL, HX5020NL

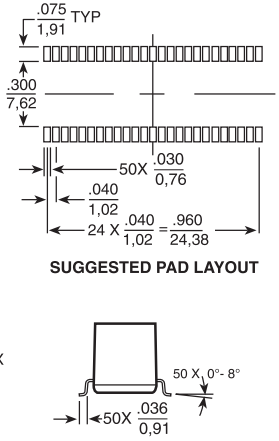
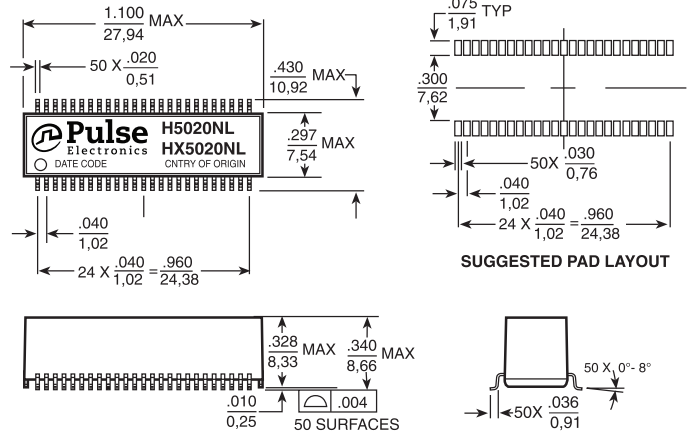

Weight . . . . . 1.6 grams  
 Tape & Reel . . . . . 250/reel  
 Tube . . . . . 15/tube

### H5015NL

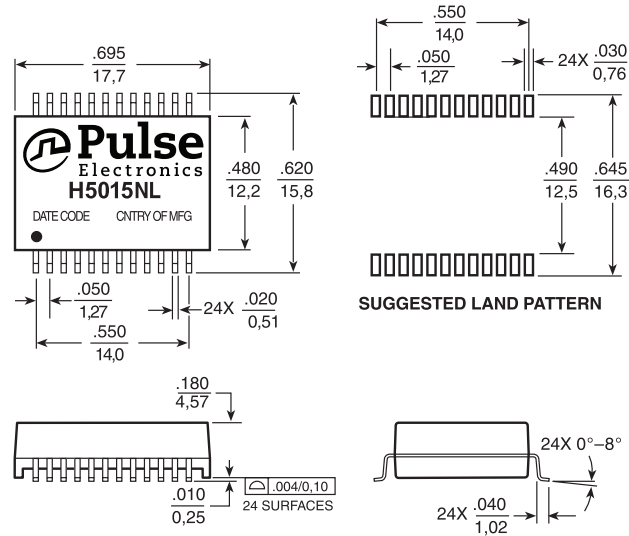

Weight . . . . . 1.5 grams  
 Tape & Reel . . . . . 400/reel

Dimensions: Inches \_\_\_\_\_  
 mm \_\_\_\_\_  
 Unless otherwise specified, all tolerances are  $\pm \frac{.005}{0,13}$

# 1000BASE-T MAGNETICS MODULE

Designed to Support 1:1 Turns Ratio Transceivers

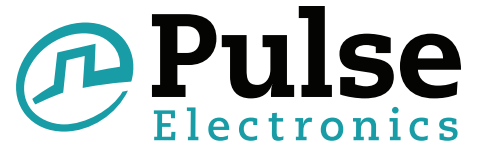

## Schematics

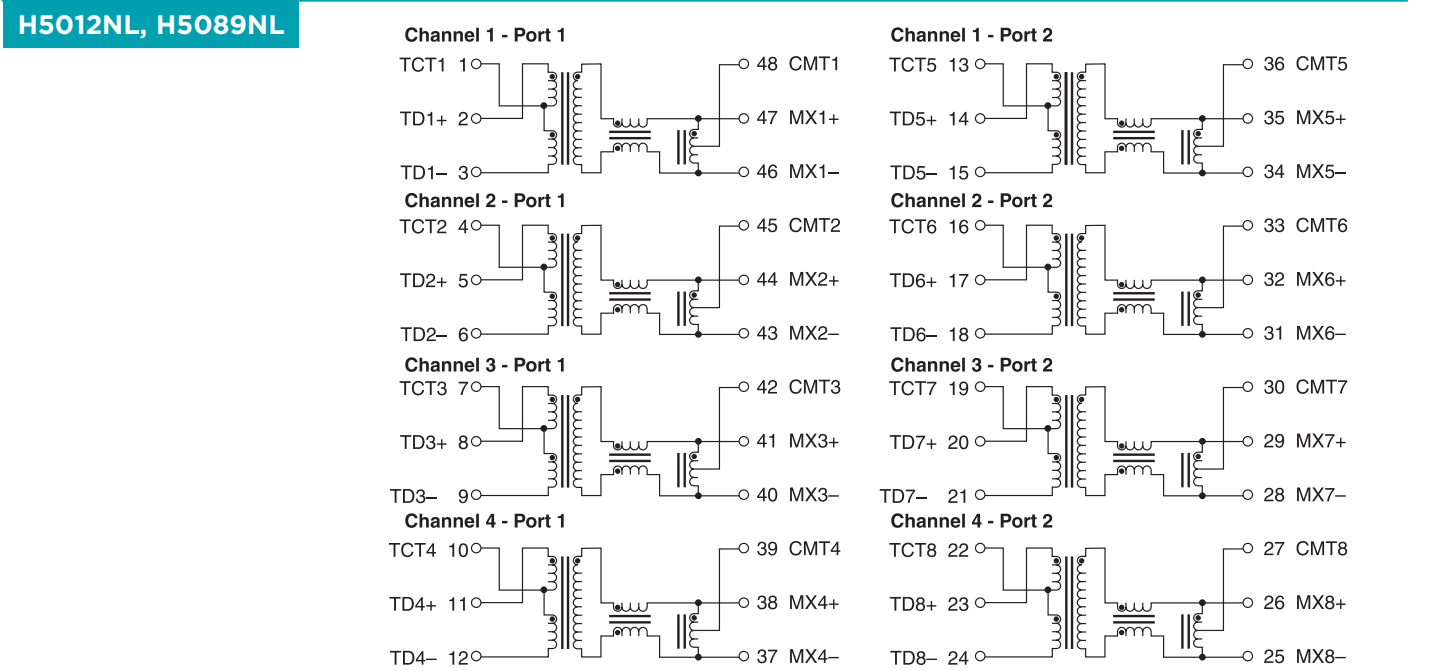
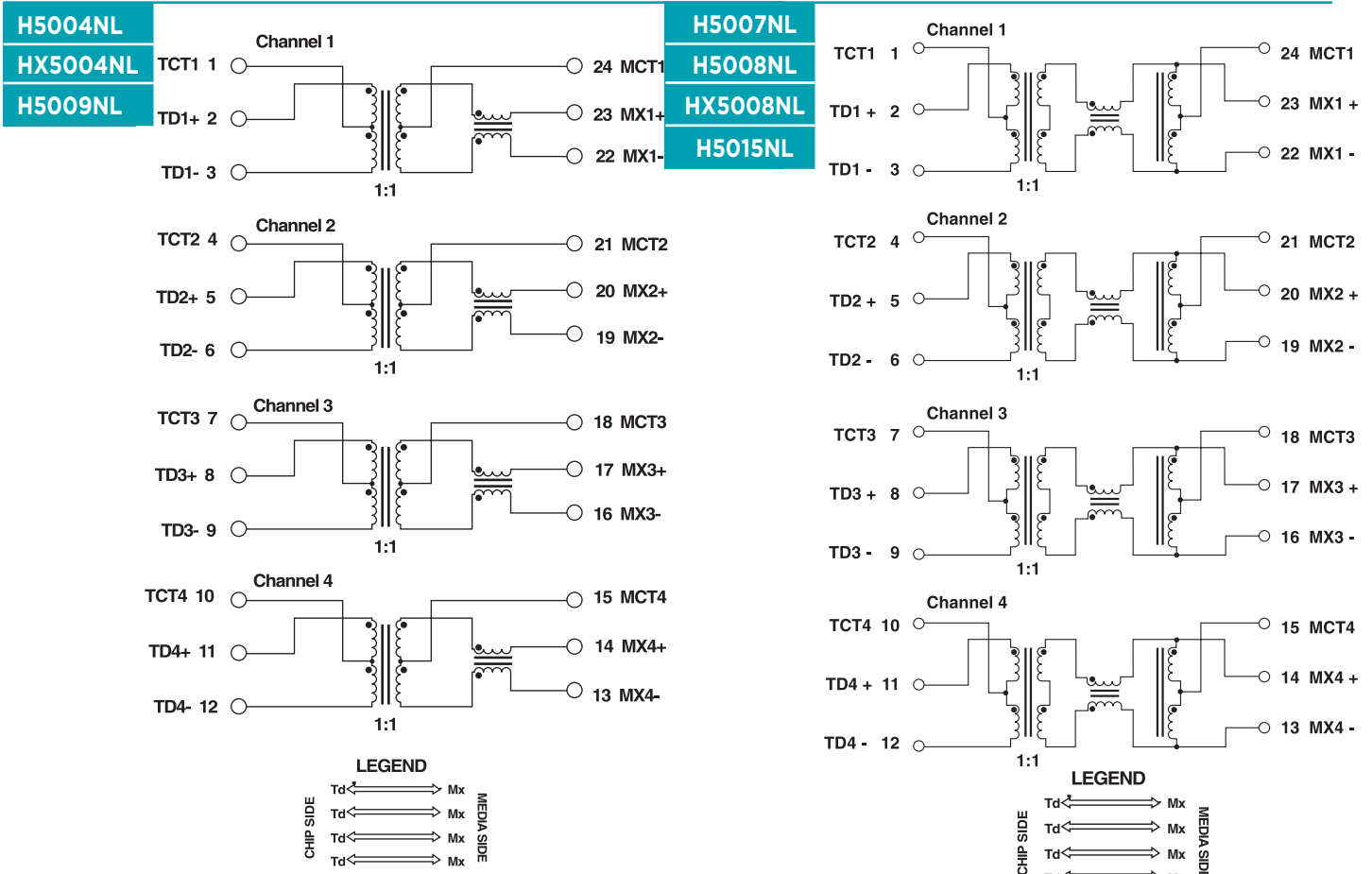

# 1000BASE-T MAGNETICS MODULE

Designed to Support 1:1 Turns Ratio Transceivers



## Schematics (continued)

### H5014NL, HX5014NL

#### Channel 1 - Port 1

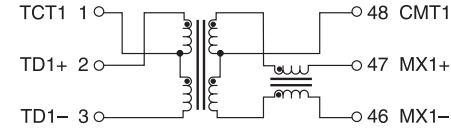

#### Channel 2 - Port 1

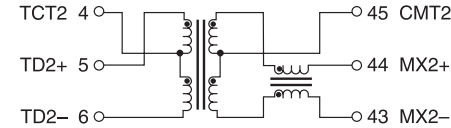

#### Channel 3 - Port 1

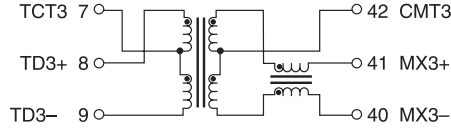

#### Channel 4 - Port 1

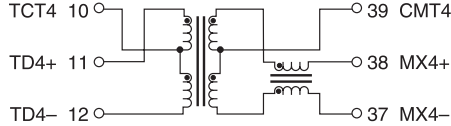

#### Channel 1 - Port 2

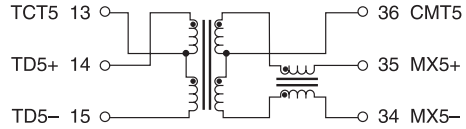

#### Channel 2 - Port 2

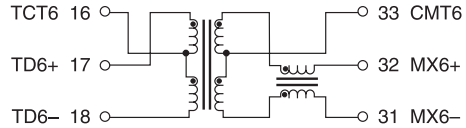

#### Channel 3 - Port 2

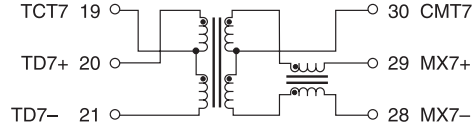

#### Channel 4 - Port 2

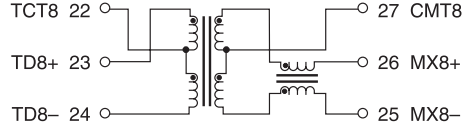

### H5020NL, HX5020NL

#### Channel 1 - Port 1

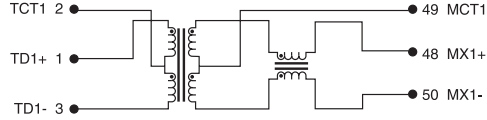

#### Channel 2 - Port 1

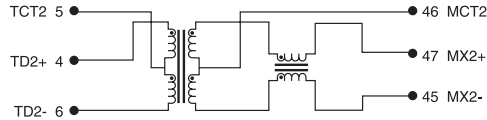

#### Channel 3 - Port 1

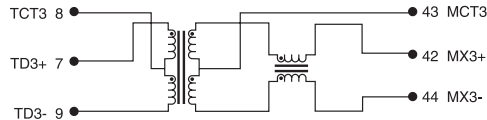

#### Channel 4 - Port 1

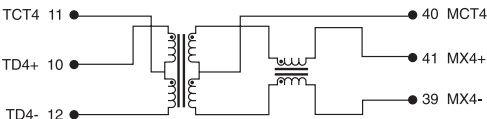

#### Channel 1 - Port 2

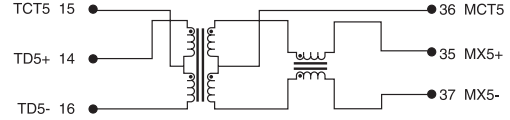

#### Channel 2 - Port 2

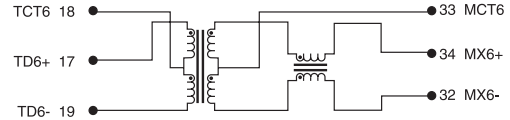

#### Channel 3 - Port 2

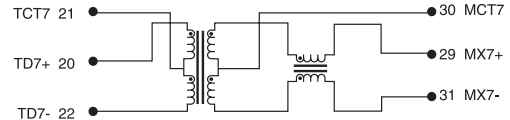

#### Channel 4 - Port 2

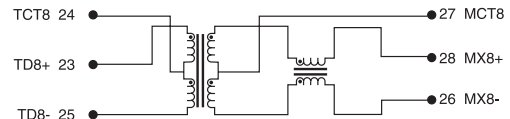

## For More Information:

**Pulse North America Headquarters**  
12220 World Trade Dr.  
San Diego, CA 92128  
U.S.A.

**Pulse Europe Headquarter**  
Zeppelinstrasse 15  
71083 Herrenberg  
Germany

**Pulse China Headquarters**  
B402, Shenzhen Academy of  
Aerospace Technology Bldg.  
10th Kejianan Rd.  
High-Tech Zone  
Nanshan District  
Shenzhen, PR China 518057  
Tel: 86 755 33966678  
Fax: 86 755 33966700

**Pulse North China**  
Room 2704/2705  
Super Ocean Finance Ctr.  
No. 2067 Yan An Rd. West  
Shanghai 200336  
China  
Tel: 8621 6278 7060  
Fax: 8621 6278 6973

**Pulse South Asia**  
135 Joo Seng Rd.  
#03-02  
PM Industrial Bldg.  
Singapore 368363  
Tel: 65 6287 8998  
Fax: 65 6287 8998

**Pulse North Asia**  
3F, No. 198  
Zhongyuan Rd.  
Zhongli City  
Taoyuan County 320  
Taiwan R. O. C.  
Tel: 886 3 4356768  
Fax: FRE 886 3 4356820  
Pulse: 886 3 4356823

Performance warranty of products offered on this data sheet is limited to the parameters specified. Data is subject to change without notice. Other brand and product names mentioned herein may be trademarks or registered trademarks of their respective owners. Pulse and the Squarewave logo are trademarks of Pulse Electronics, Inc., registered in the U.S. and other countries. © Copyright, 2013. Pulse Electronics Corporation. All rights reserved.