

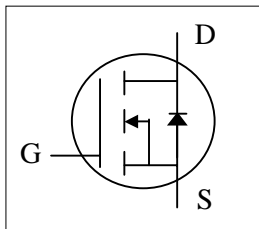

- ▼ Fast Switching Performance
- ▼ Single Drive Requirement
- ▼ Full Isolation Package



BV_{DSS}	60V
$R_{DS(ON)}$	36m Ω
I_D	23A

Description

The Advanced Power MOSFETs from APEC provide the designer with the best combination of fast switching, ruggedized device design, low on-resistance and cost-effectiveness.

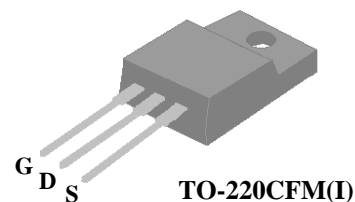

The TO-220CFM isolation package is universally preferred for all commercial-industrial through hole applications.

Absolute Maximum Ratings

Symbol	Parameter	Rating	Units
V_{DS}	Drain-Source Voltage	60	V
V_{GS}	Gate-Source Voltage	± 20	V
$I_D @ T_C=25^\circ C$	Continuous Drain Current, $V_{GS} @ 10V$	23	A
$I_D @ T_C=100^\circ C$	Continuous Drain Current, $V_{GS} @ 10V$	14	A
I_{DM}	Pulsed Drain Current ¹	80	A
$P_D @ T_C=25^\circ C$	Total Power Dissipation	31.3	W
	Linear Derating Factor	0.25	W/ $^\circ C$
T_{STG}	Storage Temperature Range	-55 to 150	$^\circ C$
T_J	Operating Junction Temperature Range	-55 to 150	$^\circ C$

Thermal Data

Symbol	Parameter	Value	Units
Rthj-c	Thermal Resistance Junction-case	Max. 4.0	$^\circ C/W$
Rthj-a	Thermal Resistance Junction-ambient	Max. 65	$^\circ C/W$



Electrical Characteristics @T_j=25°C(unless otherwise specified)

Symbol	Parameter	Test Conditions	Min.	Typ.	Max.	Units
BV _{DSS}	Drain-Source Breakdown Voltage	V _{GS} =0V, I _D =250uA	60	-	-	V
ΔBV _{DSS} /ΔT _j	Breakdown Voltage Temperature Coefficient	Reference to 25°C, I _D =1mA	-	0.05	-	V/°C
R _{DS(ON)}	Static Drain-Source On-Resistance ²	V _{GS} =10V, I _D =18A	-	-	36	mΩ
		V _{GS} =4.5V, I _D =12A	-	-	50	mΩ
V _{GS(th)}	Gate Threshold Voltage	V _{DS} =V _{GS} , I _D =250uA	1	-	3	V
g _{fs}	Forward Transconductance	V _{DS} =10V, I _D =18A	-	17	-	S
I _{DSS}	Drain-Source Leakage Current (T _j =25°C)	V _{DS} =60V, V _{GS} =0V	-	-	10	uA
	Drain-Source Leakage Current (T _j =150°C)	V _{DS} =48V, V _{GS} =0V	-	-	25	uA
I _{GSS}	Gate-Source Leakage	V _{GS} =±20V	-	-	±100	nA
Q _g	Total Gate Charge ²	I _D =18A	-	18	30	nC
Q _{gs}	Gate-Source Charge	V _{DS} =48V	-	6	-	nC
Q _{gd}	Gate-Drain ("Miller") Charge	V _{GS} =4.5V	-	11	-	nC
t _{d(on)}	Turn-on Delay Time ²	V _{DS} =30V	-	9	-	ns
t _r	Rise Time	I _D =18A	-	24	-	ns
t _{d(off)}	Turn-off Delay Time	R _G =3.3Ω, V _{GS} =10V	-	26	-	ns
t _f	Fall Time	R _D =1.67Ω	-	7	-	ns
C _{iss}	Input Capacitance	V _{GS} =0V	-	1700	2700	pF
C _{oss}	Output Capacitance	V _{DS} =25V	-	160	-	pF
C _{rss}	Reverse Transfer Capacitance	f=1.0MHz	-	110	-	pF

Source-Drain Diode

Symbol	Parameter	Test Conditions	Min.	Typ.	Max.	Units
V _{SD}	Forward On Voltage ²	I _S =25A, V _{GS} =0V	-	-	1.2	V
t _{rr}	Reverse Recovery Time ²	I _S =18A, V _{GS} =0V,	-	37	-	ns
Q _{rr}	Reverse Recovery Charge	dI/dt=100A/μs	-	38	-	nC

Notes:

- 1.Pulse width limited by Max. junction temperature.
- 2.Pulse test

THIS PRODUCT IS AN ELECTROSTATIC SENSITIVE, PLEASE HANDLE WITH CAUTION.

THIS PRODUCT HAS BEEN QUALIFIED FOR CONSUMER MARKET. APPLICATIONS OR USES AS CRITERIAL COMPONENT IN LIFE SUPPORT DEVICE OR SYSTEM ARE NOT AUTHORIZED.

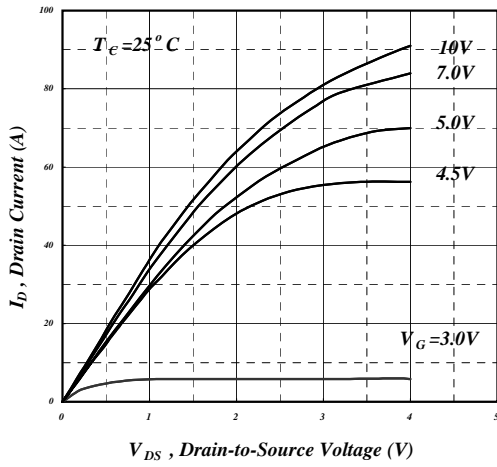

Fig 1. Typical Output Characteristics

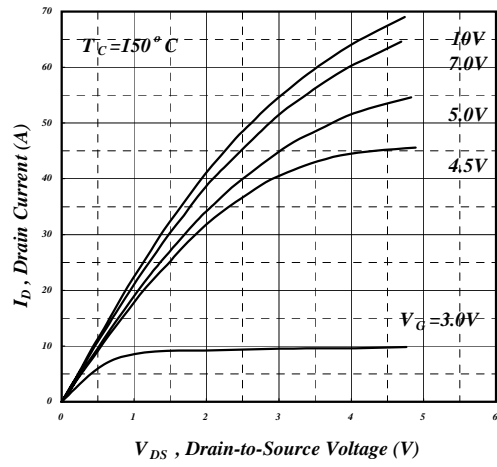

Fig 2. Typical Output Characteristics

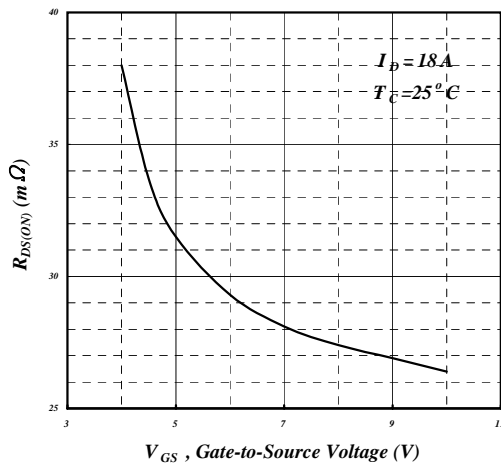

Fig 3. On-Resistance v.s. Gate Voltage

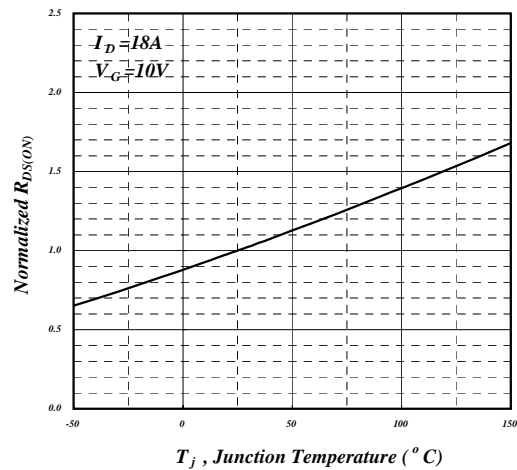

Fig 4. Normalized On-Resistance v.s. Junction Temperature

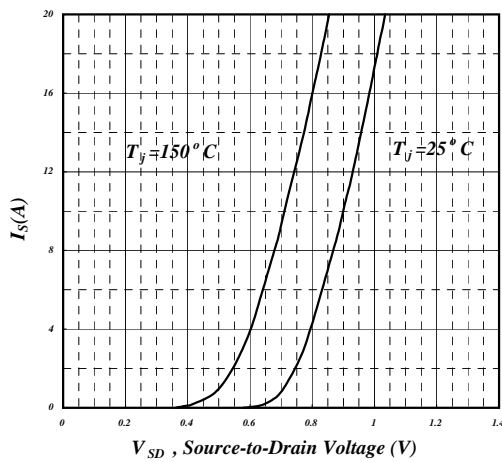

Fig 5. Forward Characteristic of Reverse Diode

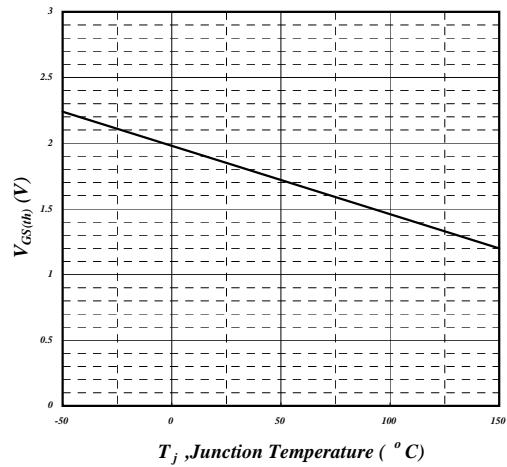

Fig 6. Gate Threshold Voltage v.s. Junction Temperature

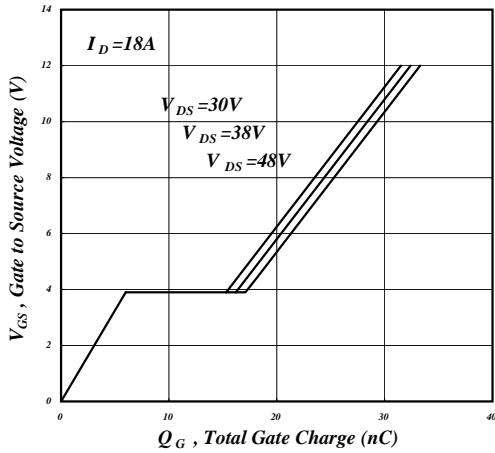

Fig 7. Gate Charge Characteristics

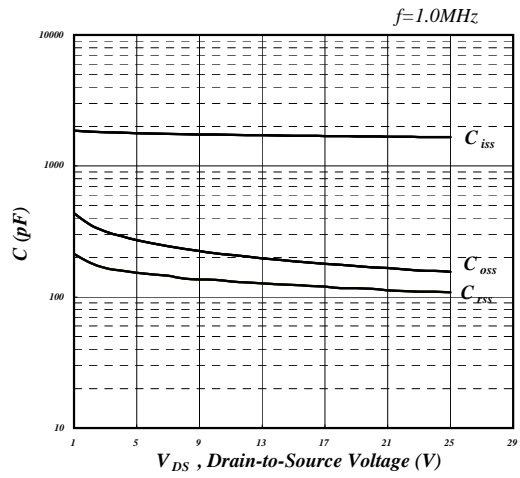

Fig 8. Typical Capacitance Characteristics

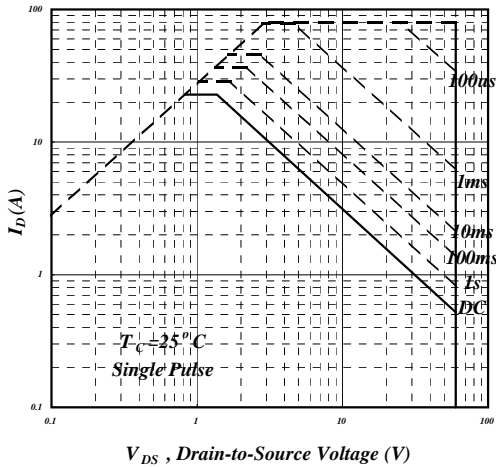

Fig 9. Maximum Safe Operating Area

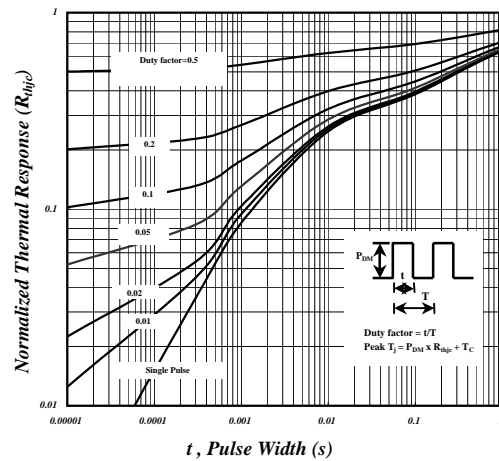

Fig 10. Effective Transient Thermal Impedance

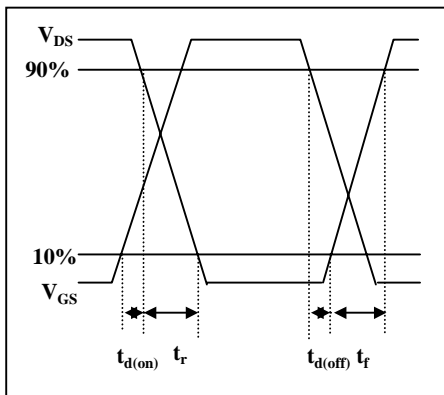

Fig 11. Switching Time Waveform

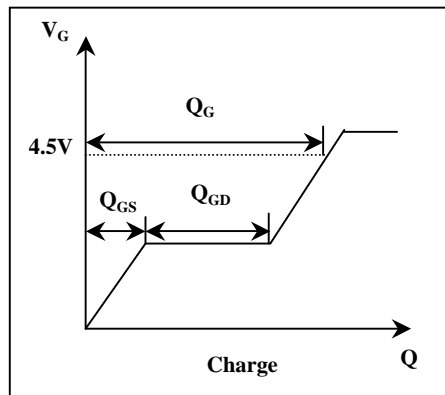
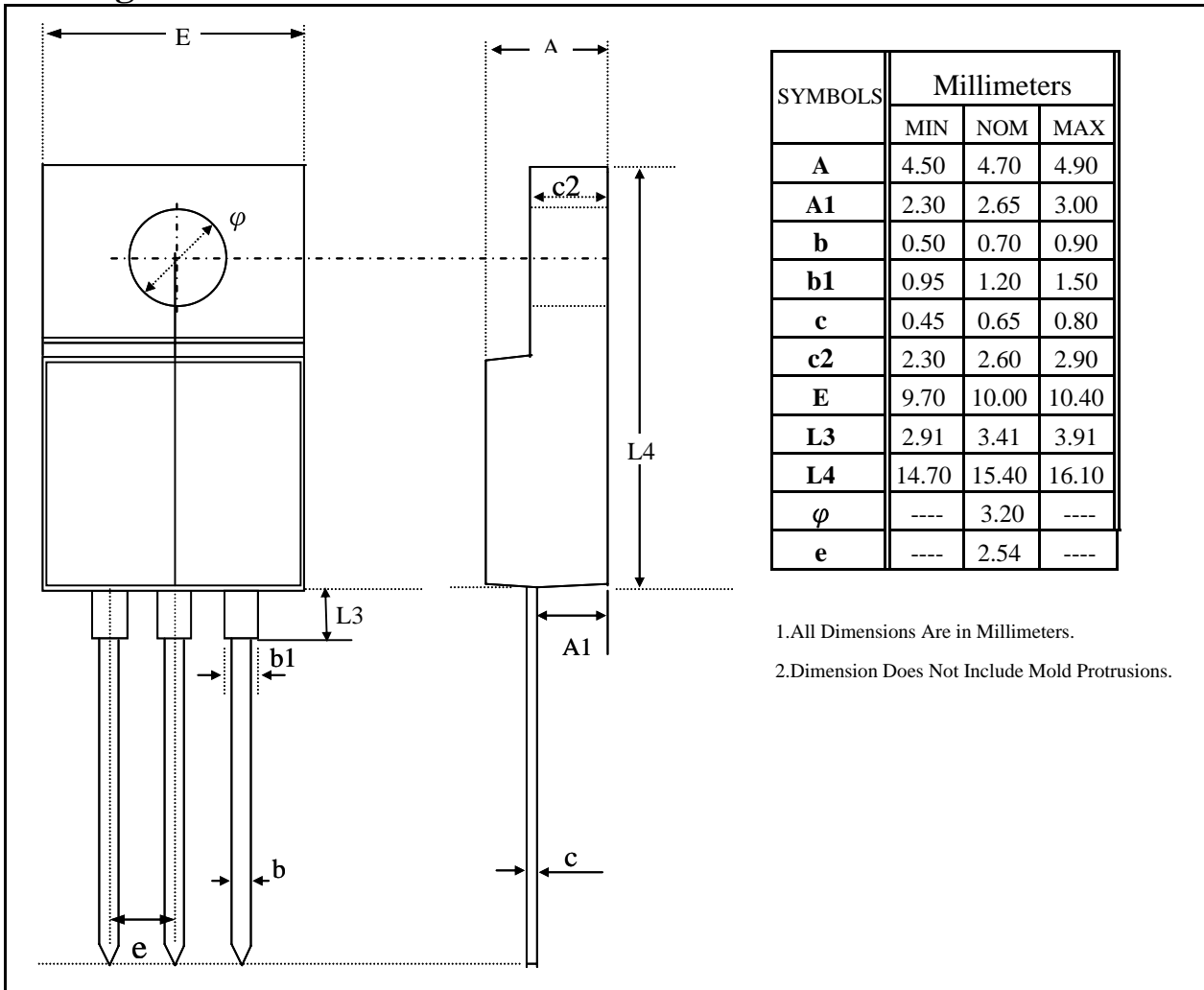

Fig 12. Gate Charge Waveform



Package Outline : TO-220CFM



Part Marking Information & Packing : TO-220CFM

