

## Trench™ Power MOSFET

**IXTA60N20T**  
**IXTP60N20T**  
**IXTQ60N20T**

**V<sub>DSS</sub> = 200V**  
**I<sub>D25</sub> = 60A**  
**R<sub>DS(on)</sub> ≤ 40mΩ**

N-Channel Enhancement Mode  
For PDP Drivers  
Avalanche Rated



TO-263 AA (IXTA)

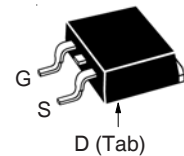

TO-220AB (IXTP)

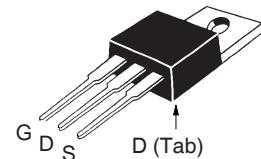

TO-3P (IXTQ)

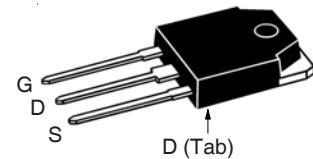

G = Gate      D = Drain  
S = Source    Tab = Drain

Symbol	Test Conditions	Maximum Ratings	
V <sub>DSS</sub>	T <sub>J</sub> = 25°C to 175°C	200	V
V <sub>DGR</sub>	T <sub>J</sub> = 25°C to 175°C, R <sub>GS</sub> = 1MΩ	200	V
V <sub>GSS</sub>	Continuous	±20	V
V <sub>GSM</sub>	Transient	±30	V
I <sub>D25</sub>	T <sub>C</sub> = 25°C	60	A
I <sub>DM</sub>	T <sub>C</sub> = 25°C, Pulse Width Limited by T <sub>JM</sub>	150	A
I <sub>A</sub>	T <sub>C</sub> = 25°C	30	A
E <sub>AS</sub>	T <sub>C</sub> = 25°C	700	mJ
P <sub>D</sub>	T <sub>C</sub> = 25°C	500	W
T <sub>J</sub>		-55 ... +175	°C
T <sub>JM</sub>		175	°C
T <sub>stg</sub>		-55 ... +175	°C
T <sub>L</sub>	1.6mm (0.062in.) from Case for 10s	300	°C
T <sub>sold</sub>	Plastic Body for 10 Seconds	260	°C
M <sub>d</sub>	Mounting Torque (TO-220 & TO-3P)	1.13 / 10	Nm/lb.in.
Weight	TO-263	2.5	g
	TO-220	3.0	g
	TO-3P	5.5	g

Symbol	Test Conditions (T <sub>J</sub> = 25°C Unless Otherwise Specified)	Characteristic Values		
		Min.	Typ.	Max.
BV <sub>DSS</sub>	V <sub>GS</sub> = 0V, I <sub>D</sub> = 250μA	200		V
V <sub>GS(th)</sub>	V <sub>DS</sub> = V <sub>GS</sub> , I <sub>D</sub> = 250μA	3.0		5.0 V
I <sub>GSS</sub>	V <sub>GS</sub> = ±20V, V <sub>DS</sub> = 0V			±200 nA
I <sub>DSS</sub>	V <sub>DS</sub> = V <sub>DSS</sub> , V <sub>GS</sub> = 0V T <sub>J</sub> = 150°C			1 μA 250 μA
R <sub>DS(on)</sub>	V <sub>GS</sub> = 10V, I <sub>D</sub> = 0.5 • I <sub>D25</sub> , Note 1	32	40	mΩ

### Features

- High Current Handling Capability
- 175°C Operating Temperature
- Avalanche Rated
- Fast Intrinsic Rectifier
- Low R<sub>DS(on)</sub>

### Advantages

- Easy to Mount
- Space Savings
- High Power Density

### Applications

- DC-DC Converters
- Battery Chargers
- Switch-Mode and Resonant-Mode Power Supplies
- DC Choppers
- AC Motor Drives
- Uninterruptible Power Supplies
- High Speed Power Switching Applications

Symbol	Test Conditions ( $T_J = 25^\circ\text{C}$ , Unless Otherwise Specified)	Characteristic Values		
		Min.	Typ.	Max.
$g_{fs}$	$V_{DS} = 10\text{V}$ , $I_D = 0.5 \cdot I_{D25}$ , Note 1	40	62	S
$C_{iss}$	$V_{GS} = 0\text{V}$ , $V_{DS} = 25\text{V}$ , $f = 1\text{MHz}$		4530	pF
$C_{oss}$			490	pF
$C_{rss}$			72	pF
$t_{d(on)}$	<b>Resistive Switching Times</b> $V_{GS} = 10\text{V}$ , $V_{DS} = 0.5 \cdot V_{DSS}$ , $I_D = 0.5 \cdot I_{D25}$ $R_G = 10\Omega$ (External)		22	ns
$t_r$			13	ns
$t_{d(off)}$			33	ns
$t_f$			22	ns
$Q_{g(on)}$	$V_{GS} = 10\text{V}$ , $V_{DS} = 0.5 \cdot V_{DSS}$ , $I_D = 0.5 \cdot I_{D25}$		73	nC
$Q_{gs}$			22	nC
$Q_{gd}$			22	nC
$R_{thJC}$			0.30	$^\circ\text{C/W}$
$R_{thCS}$	TO-220		0.50	$^\circ\text{C/W}$
$R_{thCS}$	TO-3P		0.25	$^\circ\text{C/W}$

### Source-Drain Diode

Symbol	Test Conditions ( $T_J = 25^\circ\text{C}$ , Unless Otherwise Specified)	Characteristic Values		
		Min.	Typ.	Max.
$I_S$	$V_{GS} = 0\text{V}$			60 A
$I_{SM}$	Repetitive, Pulse Width Limited by $T_{JM}$			240 A
$V_{SD}$	$I_F = 60\text{A}$ , $V_{GS} = 0\text{V}$ , Note 1			1.3 V
$t_{rr}$	$I_F = 0.5 \cdot I_{D25}$ , $V_{GS} = 0\text{V}$ $-di/dt = 100\text{A}/\mu\text{s}$ $V_R = 85\text{V}$		118	ns
$I_{RM}$			9.3	A
$Q_{RM}$			550	nC

Note 1. Pulse test,  $t \leq 300\mu\text{s}$ , duty cycle,  $d \leq 2\%$ .

### TO-263 (IXTA) Outline

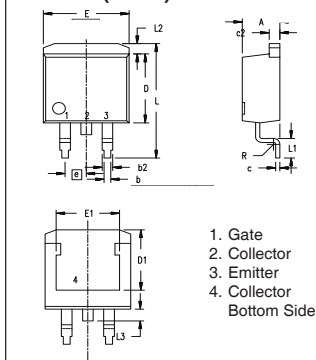

Dim.	Millimeter		Inches	
	Min.	Max.	Min.	Max.
A	4.06	4.83	.160	.190
b	0.51	0.99	.020	.039
b2	1.14	1.40	.045	.055
c	0.40	0.74	.016	.029
c2	1.14	1.40	.045	.055
D	8.64	9.65	.340	.380
D1	8.00	8.89	.280	.320
E	9.65	10.41	.380	.405
E1	6.22	8.13	.270	.320
e	2.54	BSC	.100	BSC
L	14.61	15.88	.575	.625
L1	2.29	2.79	.090	.110
L2	1.02	1.40	.040	.055
L3	1.27	1.78	.050	.070
L4	0	0.13	0	.005

### TO-220 (IXTP) Outline

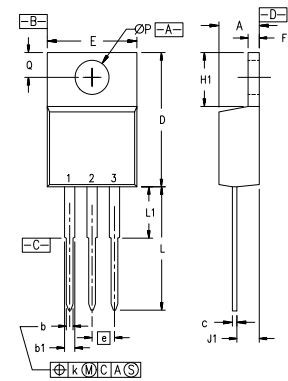

Pins: 1 - Gate 2 - Drain  
3 - Source

SYM	INCHES		MILLIMETERS	
	MIN	MAX	MIN	MAX
A	.170	.190	4.32	4.83
b	.025	.040	0.64	1.02
b1	.045	.065	1.15	1.65
c	.014	.022	0.35	0.56
D	.580	.630	14.73	16.00
E	.390	.420	9.91	10.66
e	.100	BSC	2.54	BSC
F	.045	.055	1.14	1.40
H1	.230	.270	5.85	6.85
J1	.090	.110	2.29	2.79
k	0	.015	0	0.38
L	.500	.550	12.70	13.97
L1	.110	.230	2.79	5.84
$\phi P$	.139	.161	3.53	4.08
Q	.100	.125	2.54	3.18

### TO-3P (IXTQ) Outline

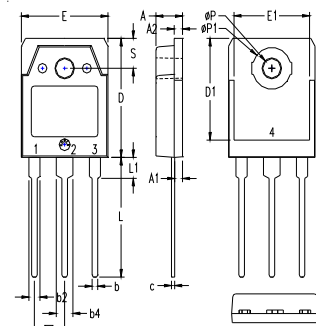

1 - GATE  
2 - DRAIN (COLLECTOR)  
3 - SOURCE (EMITTER)  
4 - DRAIN (COLLECTOR)

SYM	INCHES		MILLIMETERS	
	MIN	MAX	MIN	MAX
A	.185	.193	4.70	4.90
A1	.051	.059	1.30	1.50
A2	.057	.065	1.45	1.65
b	.035	.045	0.90	1.15
b2	.075	.087	1.90	2.20
b4	.114	.126	2.90	3.20
c	.022	.031	0.55	0.80
D	.780	.799	19.80	20.30
D1	.665	.677	16.90	17.20
E	.610	.622	15.50	15.80
E1	.531	.539	13.50	13.70
e	.215	BSC	5.45	BSC
L	.779	.795	19.80	20.20
L1	.134	.142	3.40	3.60
$\phi P$	.126	.134	3.20	3.40
$\phi P1$	.272	.280	6.90	7.10
S	.193	.201	4.90	5.10

IXYS Reserves the Right to Change Limits, Test Conditions, and Dimensions.

IXYS MOSFETs and IGBTs are covered 4,835,592 4,931,844 5,049,961 5,237,481 6,162,665 6,404,065 B1 6,683,344 6,727,585 7,005,734 B2 7,157,338 B2  
by one or more of the following U.S. patents: 4,850,072 5,017,508 5,063,307 5,381,025 6,259,123 B1 6,534,343 6,710,405 B2 6,759,692 7,063,975 B2  
4,881,106 5,034,796 5,187,117 5,486,715 6,306,728 B1 6,583,505 6,710,463 6,771,478 B2 7,071,537

Fig. 1. Output Characteristics @  $T_J = 25^\circ\text{C}$

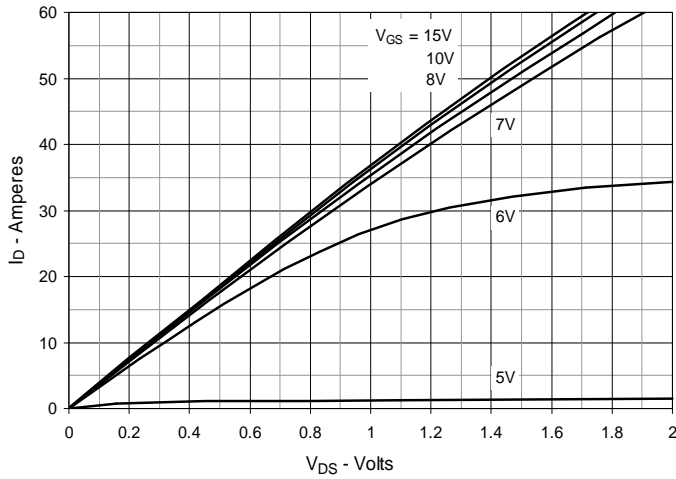

Fig. 2. Extended Output Characteristics @  $T_J = 25^\circ\text{C}$

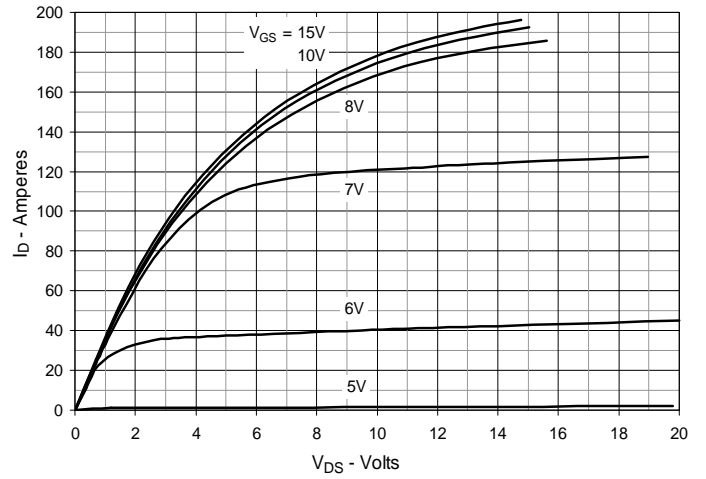

Fig. 3. Output Characteristics @  $T_J = 150^\circ\text{C}$

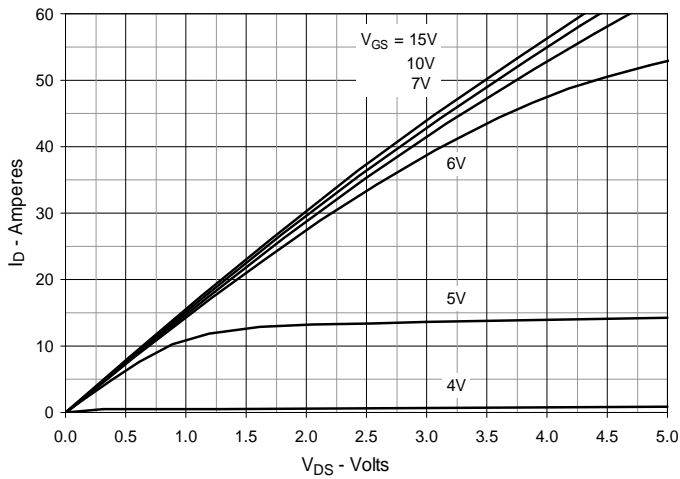

Fig. 4.  $R_{DS(on)}$  Normalized to  $I_D = 30\text{A}$  Value vs. Junction Temperature

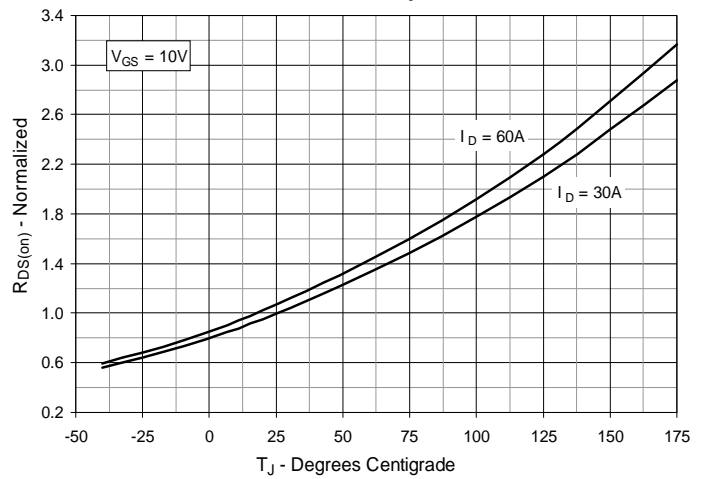

Fig. 5.  $R_{DS(on)}$  Normalized to  $I_D = 30\text{A}$  Value vs. Drain Current

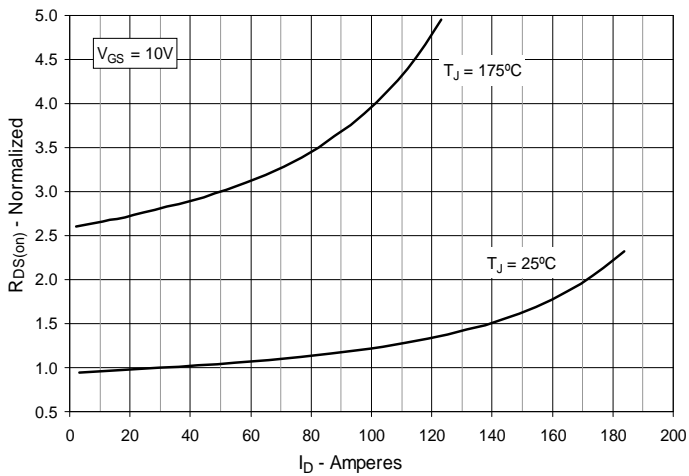

Fig. 6. Maximum Drain Current vs. Case Temperature

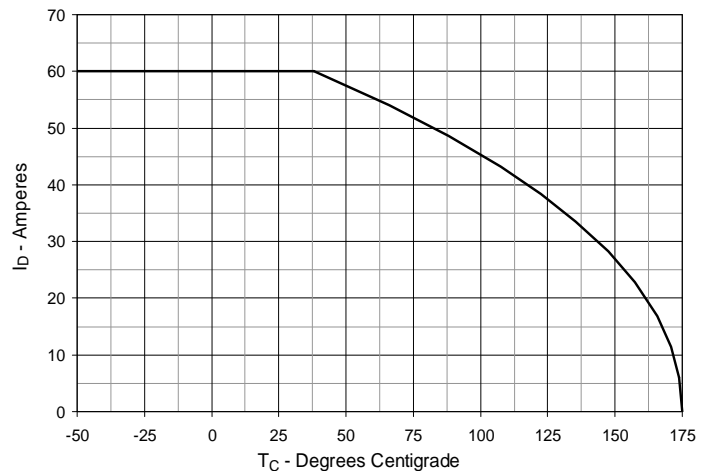

Fig. 7. Input Admittance

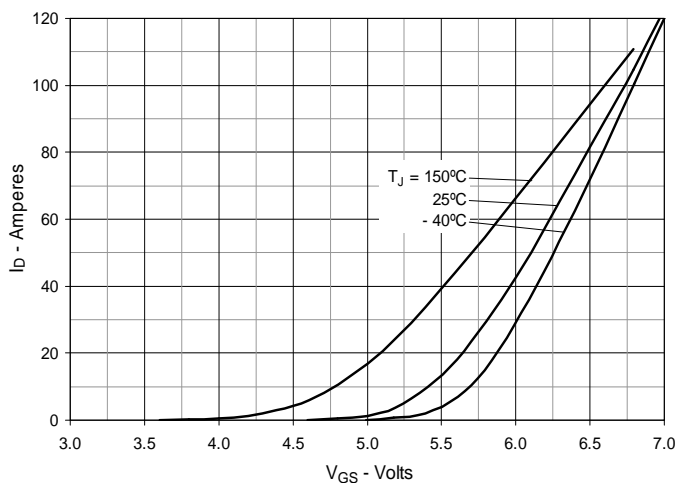

Fig. 8. Transconductance

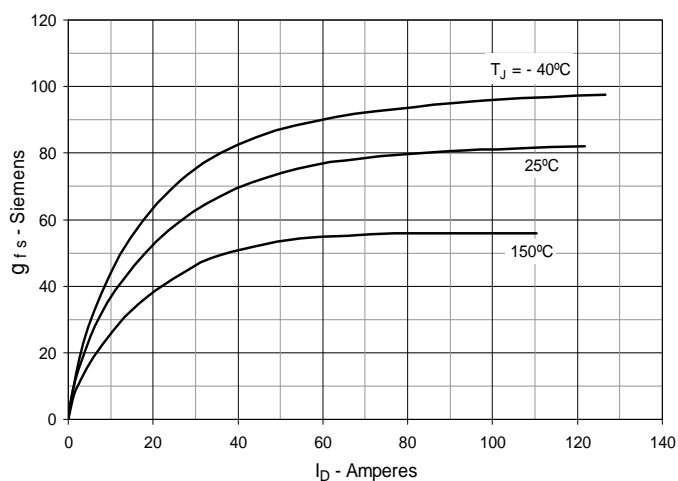

Fig. 9. Forward Voltage Drop of Intrinsic Diode

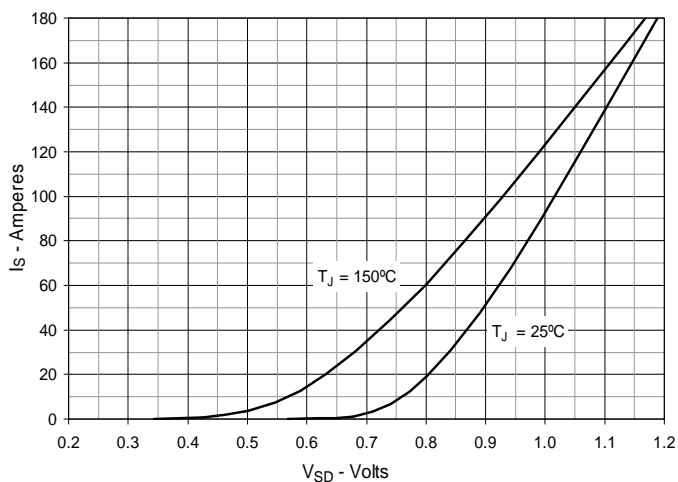

Fig. 10. Gate Charge

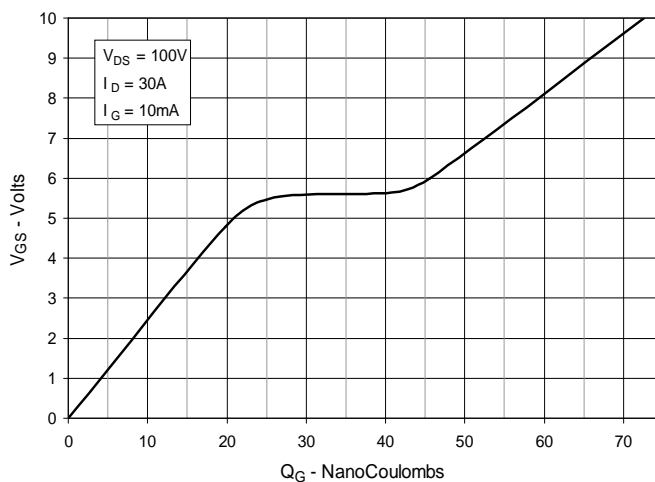

Fig. 11. Capacitance

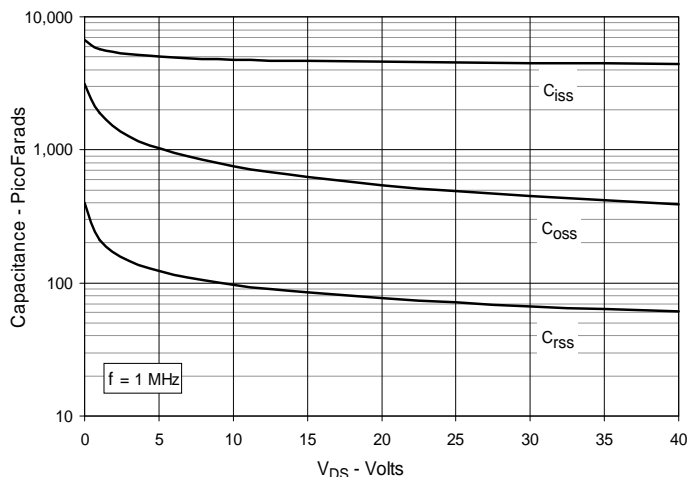

Fig. 12. Maximum Transient Thermal Impedance

