

0.4375" [11.1] Pitch, Series SSB7

SSB7FP##0202

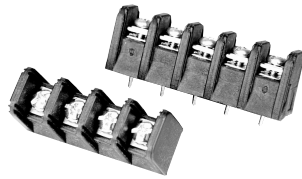

Material & Finish

Housing Material—Polypropylene

Flammability—UL94V-2

Color—Black

Terminals—Brass, bright acid tin over copper plating

Screw—#6-32 Steel with zinc + chromate plating

Mechanical Properties

Pitch (Terminal Spacing)—

.4375 in. [11.1]

Recommended PCB Hole Dia.—

.077" [1.955]

Wire Strip Length—.38" [9.652]

Recommended Tightening

Torque—8 in.-lbs.

Recommended Screwdrivers—

Stanley 1006-4, Sears Craftsman 41581, Any #2 Phillips-Head

Wire Lug Width (Max.)—8.1mm

[.320 in.]

Electrical Properties

Ratings—UL Class B 20 Amps, 600V

UL Class C 20 Amps, 600V

CSA Type C 20 Amps, 300V

CSA Type D, 5 Amps, 600V

Wire Range—12-22 AWG

Dielectric Withstand—5000V

Environmental Properties

Operating Temperature Range—

60°C to +105°C [-76°F to +221°F]

Computing Barrier Block

Lengths

Direct Mounting—Use C1 and L1 for P & H mounting options

End Position Mounting—Use L2 and C2 for M, E, F & G mounting options

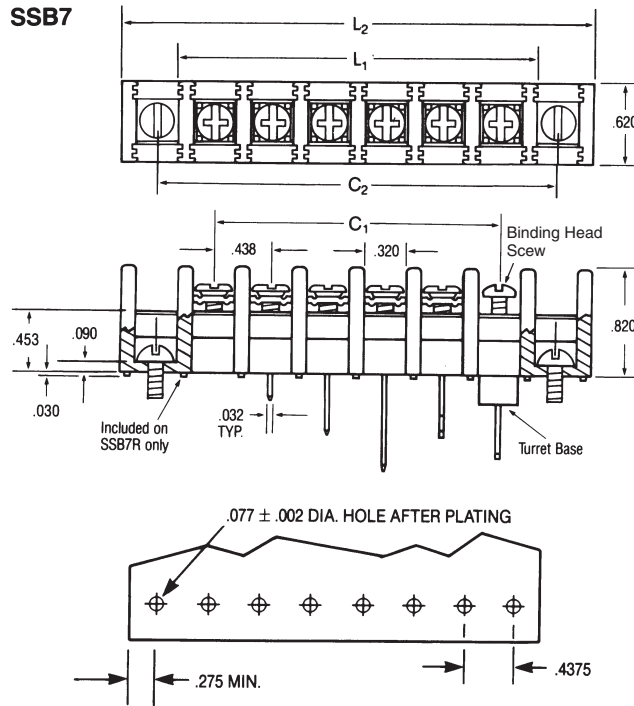

Circuits (not positions)	C1 in.	L1* in.	C2 in.	L2* in.
01	—	—	0.88	1.44
02	0.44	1.00	1.31	1.88
03	0.88	1.44	1.75	2.31
04	1.31	1.88	2.19	2.75
05	1.75	2.31	2.63	3.19
06	2.19	2.75	3.06	3.63
07	2.63	3.19	3.50	4.06
08	3.06	3.63	3.94	4.50
09	3.50	4.06	4.38	4.94
10	3.94	4.50	4.81	5.38
11	4.38	4.94	5.25	5.81
12	4.81	5.38	5.69	6.25
13	5.25	5.81	6.13	6.69
14	5.69	6.25	6.56	7.13
15	6.13	6.69	7.00	7.56
16	6.56	7.13	7.44	8.00
17	7.00	7.56	7.88	8.44
18	7.44	8.00	8.31	8.88
19	7.88	8.44	8.75	9.31
20	8.31	8.88	9.19	9.75
21	8.75	9.31	9.63	10.19
22	9.19	9.75	10.06	10.63
23	9.63	10.19	10.50	11.06
24	10.06	10.63	10.94	11.50
25	10.50	11.06	11.38	11.94
26	10.94	11.50	—	—
27	11.38	11.94	—	—

Note: All part numbers are RoHS Compliant.

0.4375" [11.1] Pitch, Series SSB7 (Continued)

Ordering Information

SSB 7 F P 06 02 02 11

A B C D E F G H

- A Single Screw Dual-Barrier Strip SSB**
- B Contact Spacing (Center-to-Center)**
7 = .4375 (7/16)
- C Base Options**
C=Closed Base
F=Flat Base
R=Raised Base
T=Turret Base
(Available only with 01, 04, 05, 07, 09, 12, 13, 15 style bottom terminals)
- D Mounting Options**
(See illustration below)
E=Open end positions, with mounting inserts, with end barriers
F=Open end positions, without mounting inserts, without end barriers
G=Open end positions, with mounting inserts, without end barriers
M=Open end positions, without mounting inserts, with end barriers
P=All positions filled with contacts, with end barriers

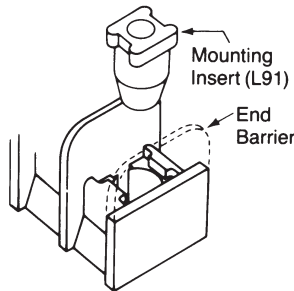

- E No. of Circuits (Not Positions)**
Must conform to mounting options
02 to 32 circuits (P & H mounting)
02 to 27 circuits (M, E, F & G mounting)
- F Terminal Style**
01=Solder Tail
02=Printed Circuit Pin
03=Non-Feed Through (with C base only)
04=Extended Printed Circuit Pin
05=Quick Connects
06=90° bend, .46" x .11" (with F base only)
07=Wire Wrap
08=90° bend, .75" x .11" (with F base only)
12=90° bend, .21" x .65"
13=90° bend, .36" x .50"
14=90° bend, .41" x .16" (with F base only)
15=90° bend, .51" x .35"
16=90° bend, .32" x .25" (with F base only)
- G Top Hardware Options**
00=No top hardware (Separately packaged binding head screws supplied at no cost)
01=Bright zinc and chromate plated steel binding head screw
02=Bright zinc and chromate plated steel screw and captive clamp - Do not order with other top hardware
03=Stainless steel binding head screw
04=Nickel plated brass binding head screw
09=Nickel plated brass screw and captive clamp - Do not order with other top hardware

80=Single-sided solder tab
81=Double-sided solder tab

Quick-Connect Blades
(supplied with 01 screw)

		.250 wide	.187 wide
		x.032 thick	x.020 thick
20	40		
21	41		
22	42		
23	43		
24	44		
25	45		
26	46		
27	47		
28	48		
29	49		
30	50		
31	51		
32	52		
33	53		
34	54		
35	55		
36	56		

H Circuit Identification Options

11	=	12345...
12	=	...54321
13	=	← 1 2 3 4 5 ...
14	=	... ← 5 4 3 2 1
15	=	12345... ←
16	=	... ← 54321

0.4375" [11.1] Pitch, Series SSB7 (Continued)

Contact Spacing Options:

.4375 in (7/16") Spacing

Extra thick barriers provide higher voltage rating. Up to 27 ckts. (25 circuits for end mounted blocks)

Base Options:

Closed Base

Catalog Letter

Code: C. For terminal junction-blocks requiring top connections only. Useful in applications requiring single point circuit terminations or circuit completion via top mounted, single- and two-sided quick-connects. Replace double-row barrier strips.

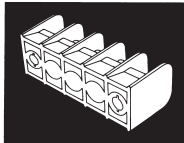

Flat Base

Catalog Letter

Code: F. Lends itself most readily to applications where direct top-to-bottom feed-through is required with no special requirement for circuit isolation on the bottom side. The most common example of this is printed circuit board mounting.

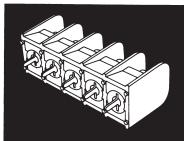

Raised Base

Catalog Letter Code R. Standoffs between each circuit raise block .030" above mounting surface to allow flux and solvents to drain during soldering operations. Available only with 02 and 04 bottom terminals.

Turret Base

Catalog Letter Code: T. Combines top-to-bottom feed-through with bottom-side circuit isolation for panels up to .126" thick. Turret bases are available with the following terminals: solder tail, quick connect, machine wrap, extended circuit board terminal, and right-angle.

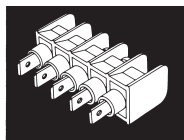

Mounting Options:

End Position

Mounting

Catalog Letter

Codes: E, F, G or M. Supplied without contacts in end sections to allow installer to mount blocks with screws in end section holes. Base of block will support mounting screws (Codes F & M). Also available with mounting inserts installed in end mounting holes to raise mounting screw heads to the level of other top hardware (Codes E & G).

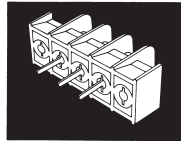

Without End Barriers

Catalog Letter Codes: F, G & H.

Facilitates mounting-screw access when end sections are used for mounting.

Direct Mounting

Catalog Letter Codes: P & H. SSBs

may be solder-mounted using the bottom terminals themselves, as in the case of printed circuit board applications.

Direct mounting is also possible with turret base models using press-on retaining clips (Catalog No. L97, Part Number 1437661-7) on turrets.

Hardware Options

7C1xx—Safety cover, see page 175

QC2x—.250 Quick connects, see page 176

QC4x—.187 Quick connects, see page 176

ST80—Single sided solder tabs, see page 176

1776090-x—Extra long Quick connects, see page 176

J7—Jumpers, see page 177

L91—Mounting insert, see page 178

L92—Angle bracket, see page 178

Terminal Style:

Solder Tail

Catalog Number

Code: 01. For applications requiring a wrapped solder connection.

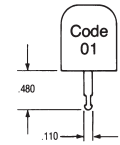

Printed Circuit Pin

Catalog Number

Code: 02.

Designed specifically for mounting on .063" thick circuit board. Special, readily solderable plating permits good fillet development in automated soldering processes.

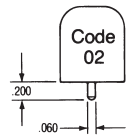

Non-Feed-Through

Catalog Number

Code: 03.

With closed base option only.



Extended Printed

Circuit Pin

Catalog Number

Code: 04.

Useful where extra length is needed, as in thicker printed circuit boards or single-wrap connections.

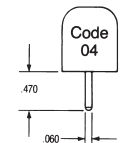

Quick Connect

Catalog Number Code:

05. .250 in. wide x .032" thick blades accept .250" female quick connects.

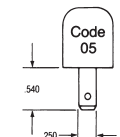

Note: All part numbers are RoHS Compliant.

0.4375" [11.1] Pitch, Series SSB7 (Continued)

**Mounting Position:
Right-Angle**

Catalog Number Codes: 06, 08, 12, 13, 14, 15, 16.

Seven variations of right-angle contacts are available. Designed for circuit board and panel applications, this option saves space when printed circuit boards are stacked closely together. It provides access to top connections in restricted spaces. Mount with angle brackets. (Catalog No. L92).

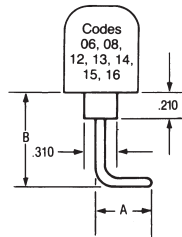

Catalog No. Code	A in.	B in.
06*	0.46	0.11
08*	0.75	0.11
12	0.21	0.65
13	0.36	0.50
14*	0.41	0.16
15	0.51	0.35
16*	0.32	0.25

*Not available with turret base

Wire Wrap

Catalog Number Code: 07.

Longer than extended circuit board terminals. Post alignment is compatible with tolerances required for automatic wire wrapping equipment. Post dimensions are compatible with standard wire wrapping bits.

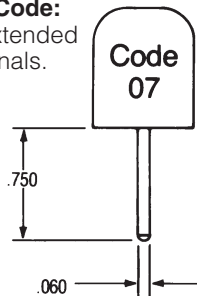

Top Hardware Options:

Binding Head Screws

In most applications, binding head screws will provide excellent wire retention because of exclusive wire locking tabs. These binding head screws are available in 3 materials identified by codes 01, 02, and 03.



Catalog Number Code:

- 01 Bright Zinc and Chromate Plated Steel
- 02 Stainless Steel
- 03 Nickel Plated Brass

Captive Clamp

For applications requiring extra security, captive clamps under the screw heads augment the locking tabs on each contact. Screws have a unique Phil-slot design accepting either Phillips-head or straight screwdriver. Code 02 screw is Bright Zinc and Chromate plated steel. Code 09 screw is Nickel plated Brass.



Catalog Number Code:

- 02 Bright Zinc and Chromate Plated Steel
- 09 Nickel Plated Brass

Catalog Number Codes: 20 through 56.

A complete selection of .187" and .250" quick-connect blades are available for connecting wire terminated with female quick connects. Single- and double-sided types in flat, 45° and 90° angle bends can be supplied. Material is brass with tin plating. All blades supplied with 01 screws. Various quick-connects can be combined.

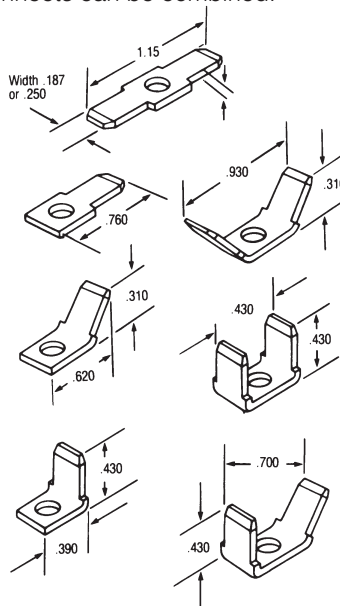

Solder Tabs

Catalog Number Code: 80. Single-sided, slotted solder tabs are available for making wrapped solder connections on the top side of SSBs.

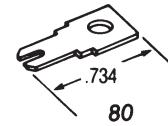

Circuit Identification Options:

Catalog Number Codes: 11 through 16.

SSB blocks may be ordered with circuit identification numbers in white on the molding in six different variations. Custom markings are available on special order.

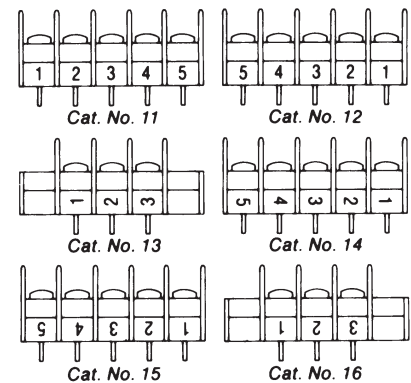

Molding Material Options:

The standard SSB molding material is UL94V-2 polypropylene. Consult Technical Support for other materials available on special order.

Molding Color Options:

SSB blocks are stocked in black. Consult Technical Support for availability of other colors.