

# Nais

## 4 AMP POLARIZED HIGH DENSITY RELAY WITH HIGH SENSITIVITY

# S-RELAYS

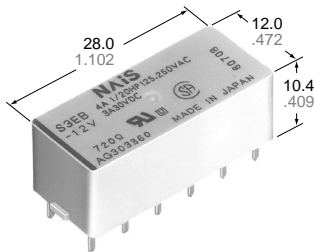

mm inch

### FEATURES

- A variety of contact arrangements 2 Form A 2 Form B, 3 Form A 1 Form B, 4 Form A
- Latching types available
- High sensitivity in small size 100 mW pick-up and 200 mW nominal operating power
- High shock and vibration resistance  
Shock: 50 G Vibration: 10 to 55 Hz at double amplitude of 3 mm
- Wide switching range From 100 $\mu$ A 100 mV DC to 4 A 250 V AC
- Low thermal electromotive force Approx. 3  $\mu$ V
- Dual-In-Line packaging arrangement

### SPECIFICATIONS

#### Contacts

Arrangement	2 Form A 2 Form B, 3 Form A 1 Form B, 4 Form A	
Initial contact resistance, max. (By voltage drop 6 V DC 1 A)	50 m $\Omega$	
Initial contact pressure	Approx. 12 g .42 oz	
Initial contact bounce, max.	1 ms	
Contact material	Gold clad silver alloy	
Electrostatic capacitance	Approx. 3pF	
Thermal electromotive force (at nominal coil voltage)	Approx. 3 $\mu$ V	
Rating (resistive)	Nominal switching capacity	4 A 250 V AC, 3 A 30 V DC
	Maximum switching power	1,000 VA, 90 W
	Maximum switching voltage	250 V AC, 30 V DC (48 VDC at less than 0.5 A)
	Max. switching current	4 A (AC), 3 A (DC)
	Min. switching capacity**1	100 $\mu$ A 100 m V DC
Expected life (min. operations)	Mechanical (at 50 cps) 10 <sup>8</sup>	
	Electrical (at 20 cpm)	4 A 250 V AC 10 <sup>5</sup>
		3 A 30 V DC 2 $\times$ 10 <sup>5</sup>

#### Coil (polarized) (at 20°C 68°F)

Single side stable	Minimum operating power	Approx. 100 mW
	Nominal operating power	Approx. 200 mW
Latching	Minimum set and reset	Approx. 100 mW
	Nominal set and reset	Approx. 200 mW

#### Notes:

\*\*1 This value can change due to the switching frequency, environmental conditions, and desired reliability level, therefore it is recommended to check this with the actual load.

#### Remarks

- \* Specifications will vary with foreign standards certification ratings.
- \*1 Measurement at same location as "Initial breakdown voltage" section
- \*2 Detection current: 10mA
- \*3 Excluding contact bounce time
- \*4 Half-wave pulse of sine wave: 11ms; detection time: 10 $\mu$ s
- \*5 Half-wave pulse of sine wave: 6ms
- \*6 Detection time: 10 $\mu$ s
- \*7 Refer to 5. Conditions for operation, transport and storage mentioned in AMBIENT ENVIRONMENT (Page 61).

#### Characteristics (at 25°C 77°F 50% Relative humidity)

Max. operating speed	20 cpm for maximum load, 50 cps for low-level load (1 mA 1 V DC)	
Initial insulation resistance*1	10,000 M $\Omega$ at 500 V DC	
Initial breakdown voltage*2	Between open contacts	750 Vrms
	Between contact sets	1,000 Vrms
	Between contacts and coil	1,500 Vrms
Operate time*3 (at nominal voltage)(at 20°C)	Max. 15 ms (Approx. 8 ms)	
Release time (without diode)*3 (at nominal voltage)(at 20°C)	Max. 10 ms (Approx. 5 ms)	
Set time*3 (latching) (at nominal voltage)(at 20°C)	Max. 15 ms (Approx. 8 ms)	
Reset time*3 (latching) (at nominal voltage)(at 20°C)	Max. 15 ms (Approx. 8 ms)	
Initial contact bounce, max.	1 ms	
Temperature rise (at nominal voltage)(at 20°C)	Max. 35°C with nominal coil voltage and at maximum switching current	
Shock resistance	Functional*4	Min. 490 m/s <sup>2</sup> {50 G}
	Destructive*5	Min. 980 m/s <sup>2</sup> {100 G}
Vibration resistance	Functional*6	176.4 m/s <sup>2</sup> {18 G}, 10 to 55 Hz at double amplitude of 3 mm
	Destructive	235.2 m/s <sup>2</sup> {24 G}, 10 to 55 Hz at double amplitude of 4 mm
Conditions for operation, transport and storage*7 (Not freezing and condens- ing at low temperature)	Ambient temp.	-40°C to +65°C -40°F to +149°F
	Humidity	5 to 85% R.H.
Unit weight	Approx. 8 g .28 oz	

### TYPICAL APPLICATIONS

Telecommunications equipment, data processing equipment, facsimiles, alarm equipment, measuring equipment.

# S

## ORDERING INFORMATION

Ex. S — 2 — L2 — 48 V

Product name	Contact arrangement	Operating function	Coil voltage, V DC
S	2: 2 Form A 2 Form B 3: 3 Form A 1 Form B 4: 4 Form A	Nil: Single side stable L: 1 coil latching L2: 2 coil latching	3, 5, 6, 12, 24, 48

Notes: 1) Standard packing; Carton 50 pcs. Case 500 pcs.  
2) UL/CSA approved type is standard.

## TYPES AND COIL DATA at 20°C 68°F

### Single side stable

Type	Nominal voltage, V DC	Pick-up voltage, V DC (max.)	Drop-out voltage, V DC (min.)	Nominal operating current, mA	Coil resistance, Ω (±10%)	Inductance, mH	Nominal operating power, mW	Maximum allowable voltage, V DC (40°C)
S□-3V	3	2.1	0.3	66.7	45	23	200	5.5
S□-5V	5	3.5	0.5	38.5	130	65	192	9.0
S□-6V	6	4.2	0.6	33.3	180	93	200	11.0
S□-12V	12	8.4	1.2	16.7	720	370	200	22.0
S□-24V	24	16.8	2.4	8.4	2,850	1,427	202	44.0
S□-48V	48	33.6	4.8	5.6	8,500	3,410	271	75.0

### 1 coil latching

Type	Nominal voltage, V DC	Pick-up voltage, V DC (max.)	Drop-out voltage, V DC (min.)	Nominal operating current, mA	Coil resistance, Ω (±10%)	Inductance, mH	Nominal operating power, mW	Maximum allowable voltage, V DC (40°C)
S□-L1-3V	3	2.1	0.3	33	90	0.04	99	8.4
S□-L1-5V	5	3.5	0.5	16	300	0.14	80	15.3
S□-L1-6V	6	4.2	0.6	16	360	0.14	96	16.8
S□-L1-12V	12	8.4	1.2	8	1450	0.6	96	33.7
S□-L1-24V	24	16.8	2.4	4	5700	2.05	96	66.7
S□-L1-48V	48	33.6	4.8	3	16,000	8.9	144	111

### 2 coil latching

Type	Nominal voltage, V DC	Set and reset voltage, V DC (max.)	Nominal operating current, mA	Coil resistance, Ω (±10%)		Inductance, mH		Nominal operating power, mW	Maximum allowable voltage, V DC (40°C)
				Coil I	Coil II	Coil I	Coil II		
S□-L2-3V	3	2.1	66.7	45	45	10	10	200	5.5
S□-L2-5V	5	3.5	38.5	130	130	31	31	192	9.0
S□-L2-6V	6	4.2	33.7	180	180	40	40	200	11.0
S□-L2-12V	12	8.4	16.7	720	720	170	170	200	22.0
S□-L2-24V	24	16.8	8.4	2,850	2,850	680	680	202	44.0
S□-L2-48V	48	33.6	7.4	6,500	6,500	1,250	1,250	355	65.0

Note: Insert 2, 3 or 4 in □ for contact form required.

## DIMENSIONS

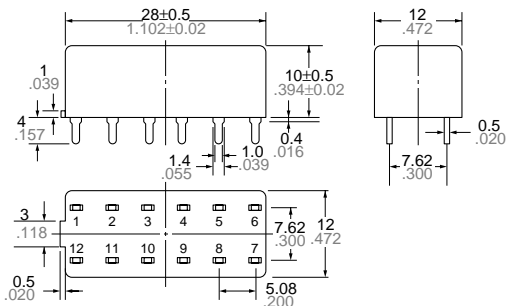

PC board pattern (Copper-side view)

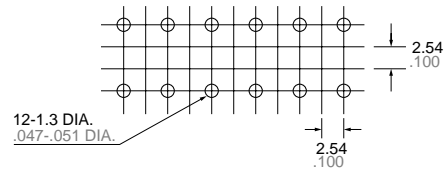

General tolerance:  $\pm 0.3 \pm .012$

Tolerance:  $\pm 0.1 \pm .003$

## Schematic (Bottom view)

Single side stable  
Deenergized position

2a2b

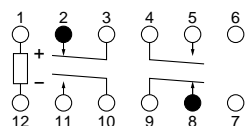

3a1b

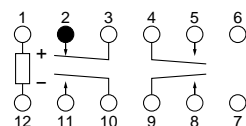

4a

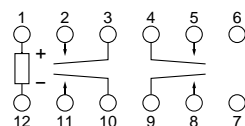

### 2 coil latching

Diagram shows the "reset" position when terminals 6 and 7 are energized. Energize terminals 1 and 2 to transfer contacts.

2a2b

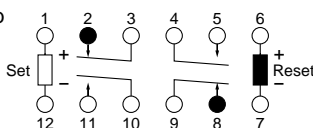

3a1b

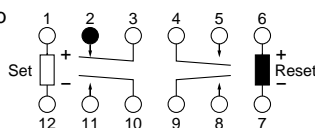

4a

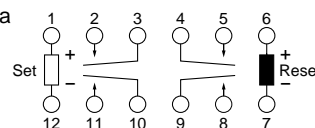

## REFERENCE DATA

### 1. Maximum switching power

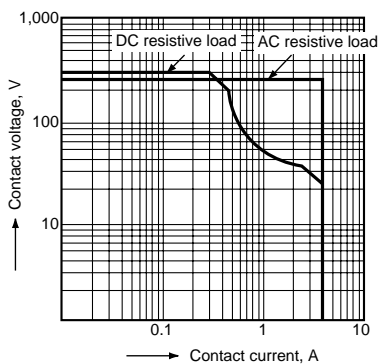

### 2. Life curve

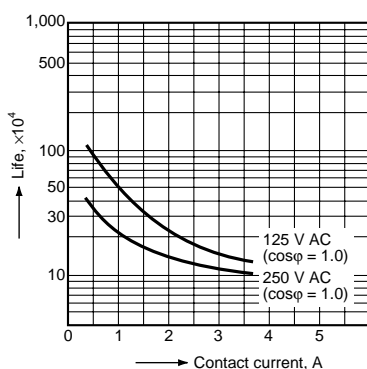

### 3. Contact reliability

Condition: 1V DC, 1mA  
Detection level 10 Ω  
Tasted Sample: S4-24V, 10pcs

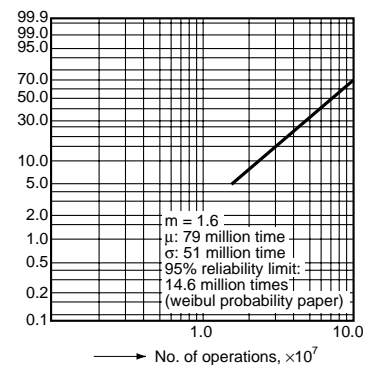

### 4.-(1) Coil temperature rise

Tested Sample: S4-24V, 4 Form A

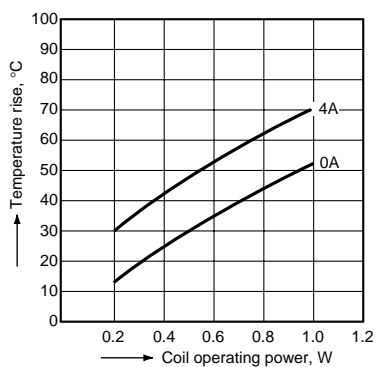

### 4.-(2) Coil temperature rise

Tested Sample: S4-24V, 4 Form A

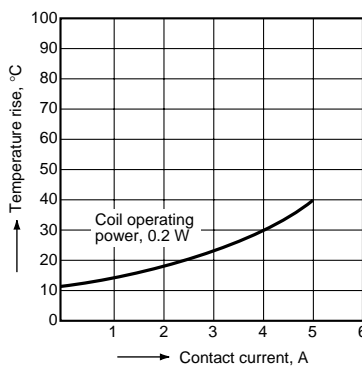

### 5.-(1) Operate and release time (Single side stable type)

Tested Sample: S4-24V, 10pcs

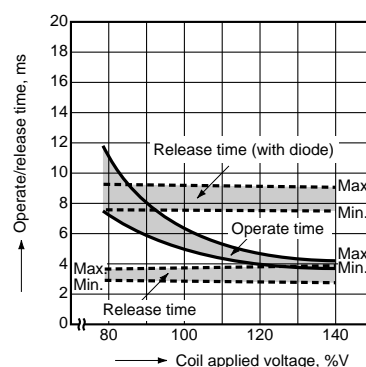

5.-(2) Operate time (2 coil latching type)  
 Tested Sample: S2-L2-12V

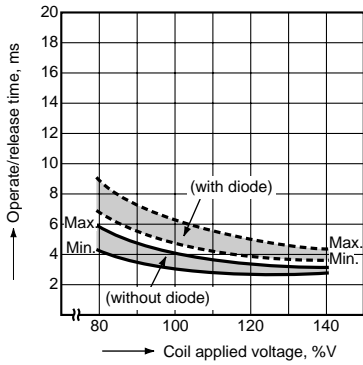

6. Influence of adjacent mounting

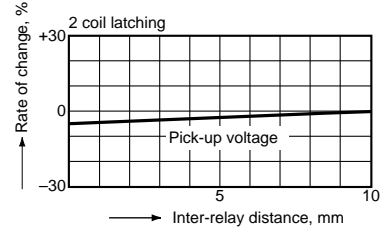
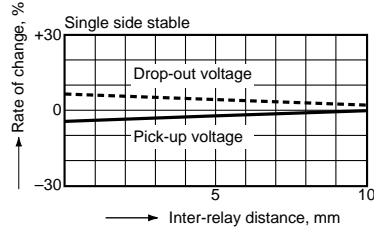
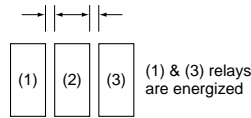

7. Thermal electromotive force

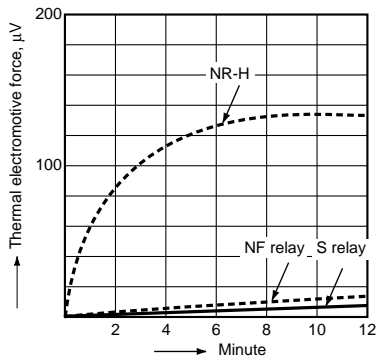

8. Effect from an external magnetic field

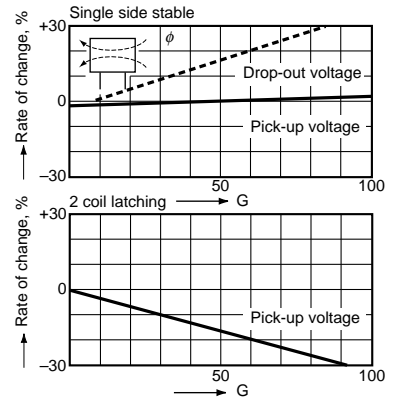
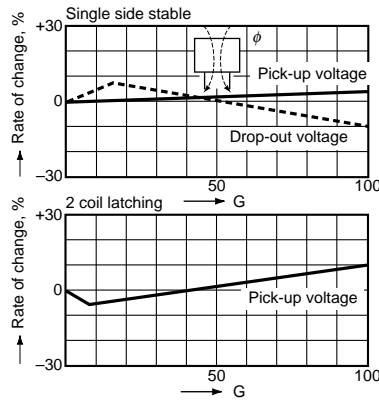

ACCESSORIES

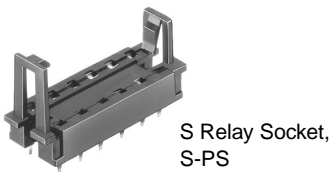

Specifications

Breakdown voltage	1,500 Vrms between terminals
Insulation resistance	More than 100 MΩ between terminals at 500 V DC Mega
Heat resistance	150 ±3°C (302 ±5.4°F) for 1 hour.
Maximum continuous current	4 A

(Note: Don't insert or remove relays while in the energized condition.)

Dimensions

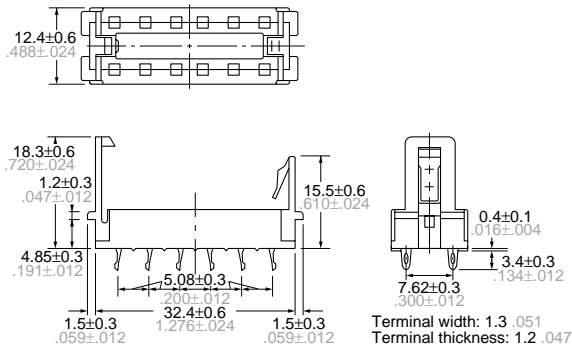

PC board pattern (Copper-side view)

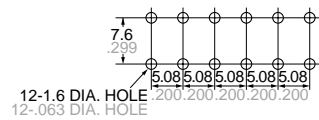

### Inserting and removing method

Inserting method: Insert the relay as shown in Fig. 1 unit the rib of the relay snaps into the clip of the socket.

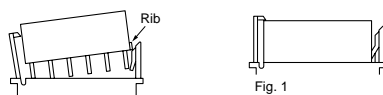

Removing method:

(1) Remove the relay straight from the socket holding the shaded portion of the relay as shown in Fig. 2.

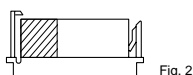

(2) When sockets are mounted in close proximity, use a slotted screw driver as shown in Fig. 3.

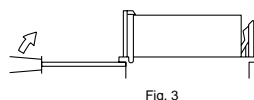

## NOTES

- Special use of 2 coil latching types: 2 ways can be considered if 2 coil latching types are used as 1 coil latching types.
  - Reverse polarity is applied to the set coil of 2 coil latching type.
  - By shorting terminals 12 and 7, apply plus to 1, minus to 6 at set and plus to 6, minus to 1 at reset. Applied coil voltage should be the same as the nominal. Operating power will be reduced to one-half.

Reset position of 2a2b type

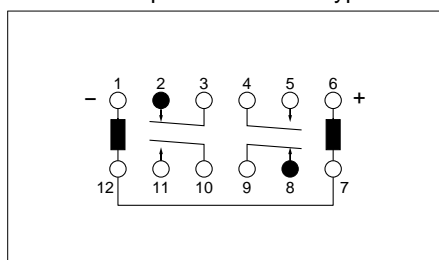

- Soldering operations should be accomplished as quick as possible; within 10 seconds at 250°C 482°F solder temperature or 3 seconds at 350°C 662°F. The header portion being sealed with epoxy resin, undue subjection to heat may cause loss of seal. Solder should not be permitted to remain on the header.

## CAUTIONS FOR USE

Based on regulations regarding insulation distance, there is a restriction on same-channel load connections between terminals No. 2, 3 and 4, 5, as well as between No. 8, 9 and 10, 11. See the figure below for an example.

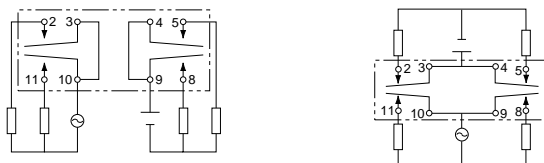

- Between 2, 3 and 4, 5: different channels, therefore not possible
- Between 10, 11 and 8, 9: different channels, therefore not possible

No good

- Between 2, 3 and 4, 5: same channels, therefore possible
- Between 10, 11 and 8, 9: same channels, therefore possible

Good

For Cautions for Use, see Relay Technical Information (Page 48 to 76).