

MINI PROPORTIONAL OUTPUT THUMBWHEEL

SHORTER BEHIND PANEL DEPTH



The HTWM offers the same performance as the standard HTW Proportional Thumbwheel but with a much shorter behind panel depth. Available with eight output options, the HTWM offers a self-centering, single axis thumbwheel actuator that provides linear change in voltage output in either direction from center. Options include increasing or decreasing voltage output from the center position to the full travel position, and single or dual (redundant) outputs per axis. The HTWM offers snap-in style mounting and a 3 million cycle rotational life. The HTWM electronics are sealed to IP68S and have excellent EMI/RFI immunity ideal for use in grip, armrest and panel applications.

Features:

- Shorter behind panel depth: 0.096"
- Eight output options
- Self-centering single axis actuator
- Rocker switch style mounting
- 3 million cycle rotational life
- Electronics sealed to IP68S
- Excellent EMI/RFI immunity
- RoHS & WEEE compliant

Standard Characteristics/Ratings:

MECHANICAL:

Mechanical Life: 3,000,000 full forward to full back

Max Allowable Radial Load: 30.0 lbs.

Drop: 3 feet max to concrete

ELECTRICAL RATINGS: Rated at Vcc = 5V @ 25°C Load = 1mA (4-7KΩ)

Electrical	Units	Min	Typ	Max
Supply Voltage	VDC	4.5	5	5.5
Output Voltage Tolerance at Center <i>(see graph for output values)</i>	VDC @ 5V Vcc	-0.25	N/A	+0.25
Output Voltage Tolerance at Full Travel <i>(see graph for output values)</i>	VDC @ 5V Vcc	-0.25	N/A	+0.25
Supply Current Per Sensor	mA	N/A	N/A	10

ELECTRONICS:

Seal Integrity: Electronics IP68S

ENVIRONMENTAL:

Operating Temp Range: -40°C to +85°C

Humidity: 96% RH, 70°C, 96 hours

Vibration: Per MIL-810F minimum integrity

Sand/Dust: Per SAE J1455

EMI: Withstand per MIL-STD-461D/SAE J1113-22

RFI: Withstand 100V/M 14Hz to 1GHz

MATERIALS:

Button: Thermoplastic

Bezel: Thermoplastic

Mounting Hardware: None provided

SHORTER BEHIND PANEL DEPTH

HTWM PART NUMBER CODE

HTWM	-	X	X	X	X	X	X
Travel	Output 1*	Output 2**	Operating Force	Button Style	Termination	Bezel Color	Button Color
1. +/- 40°	A. 2.5 +/- 2.0VDC B. 2.5 +/- 2.0VDC C. 2.5 +/- 2.0VDC D. 2.5 +/- 1.5VDC E. 2.5 +/- 1.5VDC F. 2.5 +/- 1.5VDC G. 1.0 - 4.0VDC H. 0.5 - 4.5VDC	NONE 2.5 +/- 2.0VDC 2.5 +/- 2.0VDC NONE 2.5 +/- 1.5VDC 2.5 +/- 1.5VDC 1.0 - 4.0VDC 0.5 - 4.5VDC	1. 0.5 lb.	1. Knurled Wheel 2. Paddle Wheel	A. 18 AWG Wires, 18.3" Long, Stripped Ends B. 0.025" SQ. Pins	1. Red 2. Black 3. Orange 4. Yellow 5. Green 6. Blue 7. Violet 8. Gray 9. White	1. Red 2. Black 3. Orange 4. Yellow 5. Green 6. Blue 7. Violet 8. Gray 9. White

* Outputs are from the center position to the full travel position in each direction. Options A-F provide increasing voltage in Direction 1 and decreasing voltage in Direction 2 from a single output. Options G & H provide increasing voltages in both directions from two separate outputs.

** Options B & E provide redundant output 2 which duplicates output 1. Options C & F provide redundant output 2 which is inverse of output 1.

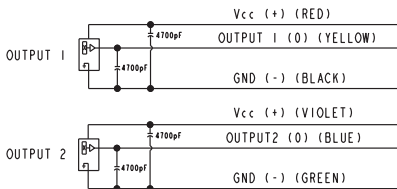
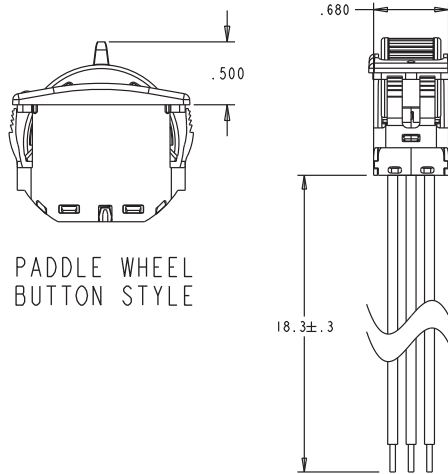
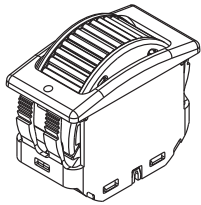

OUTPUT 2 IS NOT PRESENT IN ALL CONFIGURATIONS

MOUNTING:

RECOMMENDED PANEL THICKNESS: 0.150 OPTIMUM THICKNESS
(0.040 MIN. - 0.200 MAX.)

RECOMMENDED PANEL OPENING: 0.700 X 1.340 OPTIMUM
(0.695/0.705 X 1.335/1.345)

RECOMMENDED PANEL RADII: 0.100 OPTIMUM
(0.090 - 0.110 MAX.)

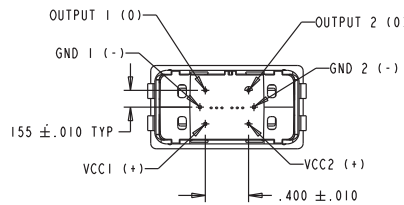
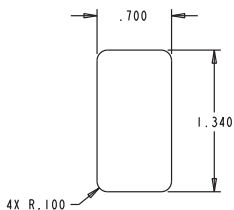

PINNED TERMINATION
NOT ALL PINS ARE PRESENT
IN ALL OUTPUT CONFIGURATIONS

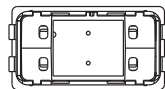

NOT ALL WIRES ARE PRESENT
IN ALL OUTPUT CONFIGURATIONS

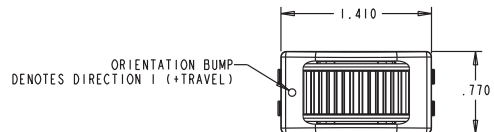
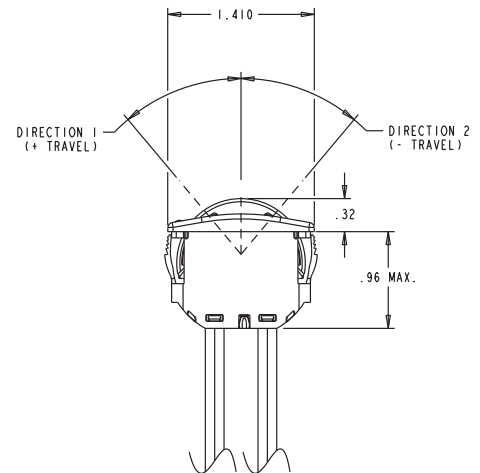

MINI PROPORTIONAL OUTPUT THUMBWHEEL

SHORTER BEHIND PANEL DEPTH

HALL EFFECT

OPTION A

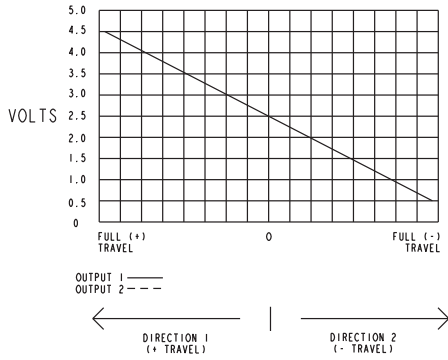

OPTION B

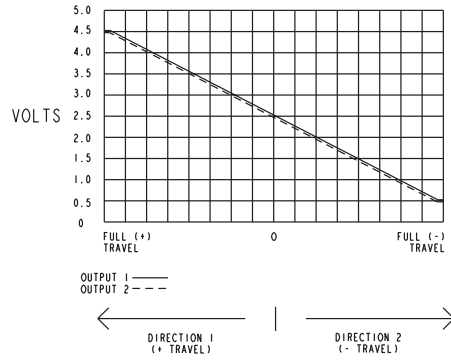

OPTION C

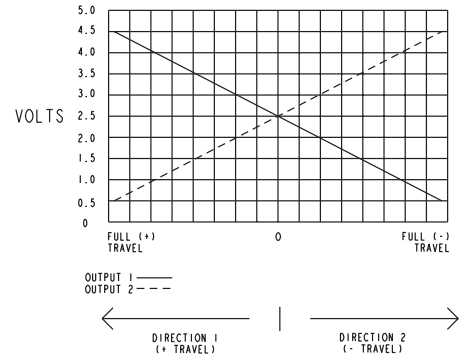

OPTION D

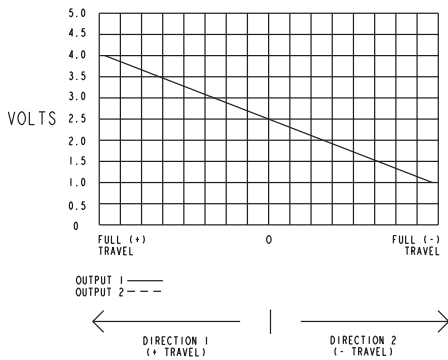

OPTION E

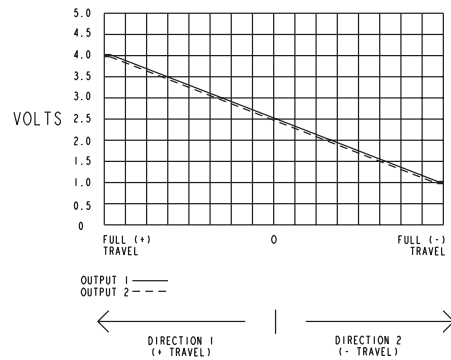

OPTION F

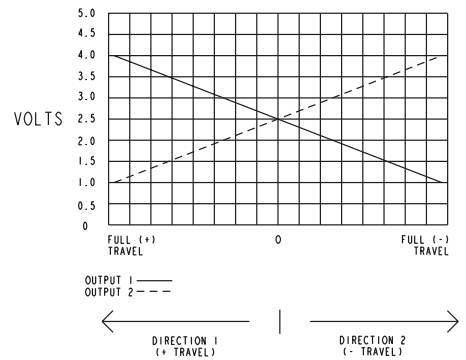

OPTION G

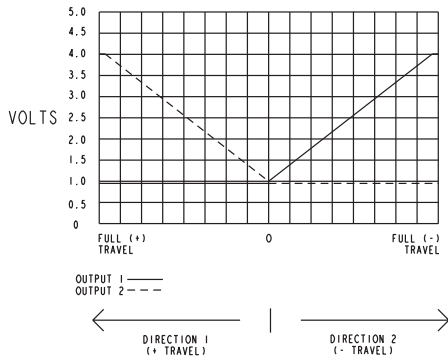

OPTION H

