

VHF amplifier modules

BGY132; BGY133

FEATURES

- Broadband VHF amplifiers
- 18 W output power
- Operate directly from 12 V vehicle electrical systems
- Output power control over a 10 dB range by drive power.

APPLICATIONS

- Mobile communication equipment.

DESCRIPTION

The BGY132 and BGY133 are two stage amplifier modules. Each module comprises two NPN silicon planar transistor chips together with lumped-element matching components.

PINNING - SOT132B

PIN	DESCRIPTION
1	RF input
2	ground
3	V_{S1}
4	ground
5	V_{S2}
6	ground
7	RF output
flange	ground

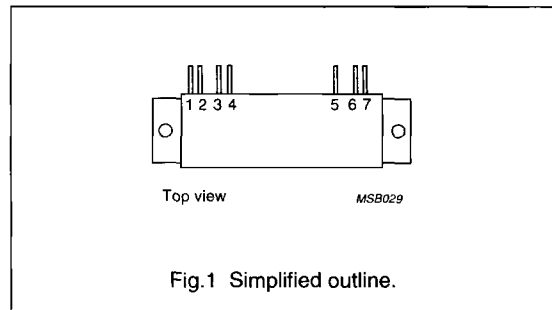

QUICK REFERENCE DATA

RF performance at $T_{mb} = 25\text{ }^{\circ}\text{C}$.

TYPE NUMBER	MODE OF OPERATION	f (MHz)	$V_{S1}; V_{S2}$ (V)	P_L (W)	G_p (dB)	η (%)	$Z_S; Z_L$ (Ω)
BGY132	CW	68 to 88	12.5	≥ 18	≥ 22.6	typ. 45	50
BGY133	CW	80 to 108	12.5	≥ 18	≥ 22.6	typ. 45	50

WARNING

Product and environmental safety - toxic materials

This product contains beryllium oxide. The product is entirely safe provided that the BeO slab is not damaged. All persons who handle, use or dispose of this product should be aware of its nature and of the necessary safety precautions. After use, dispose of as chemical or special waste according to the regulations applying at the location of the user. It must never be thrown out with the general or domestic waste.

VHF amplifier modules

BGY132; BGY133

LIMITING VALUES

In accordance with the Absolute Maximum Rating System (IEC 134).

SYMBOL	PARAMETER	MIN.	MAX.	UNIT
V_{S1}	DC supply voltage	–	15.6	V
V_{S2}	DC supply voltage	–	15.6	V
V_i	RF input terminal voltage	–	25	V
V_o	RF output terminal voltage	–	25	V
P_D	input drive power	–	200	mW
P_L	load power	–	25	W
T_{stg}	storage temperature	–40	+100	°C
T_{mb}	operating mounting base temperature	–20	+90	°C

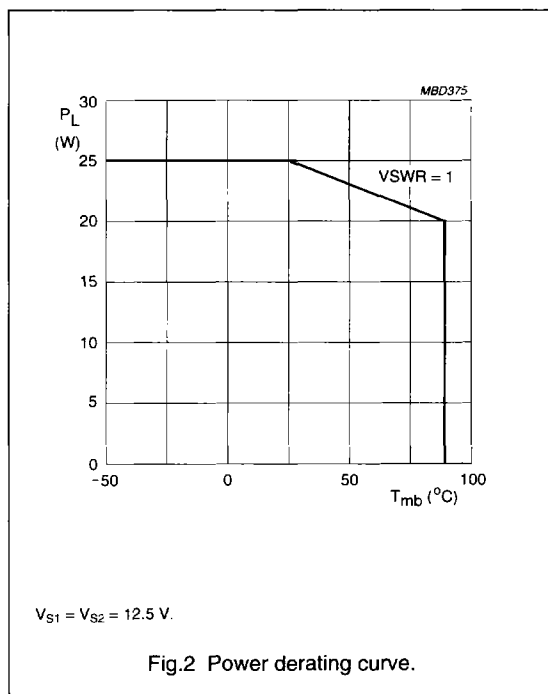

VHF amplifier modules

BGY132; BGY133

CHARACTERISTICS

$T_{mb} = 25\text{ }^\circ\text{C}$; $Z_S = Z_L = 50\text{ }\Omega$; $P_D = 100\text{ mW}$; $V_{S1} = V_{S2} = 12.5\text{ V}$; unless otherwise specified.

SYMBOL	PARAMETER	CONDITIONS	MIN.	TYP.	MAX.	UNIT
f	frequency BGY132 BGY133		68 80	–	88 108	MHz MHz
I_{O2}	leakage current	$V_{S1} = 0$; $P_D = 0$	–	–	10	mA
P_L	load power		18	–	–	W
G_p	power gain	$P_L = 18\text{ W}$; note 1	22.6	–	–	dB
η	efficiency	$P_L = 18\text{ W}$; note 1	38	45	–	%
H_2	second harmonic	$P_L = 18\text{ W}$; note 1	–	–	–25	dBc
H_3	third harmonic	$P_L = 18\text{ W}$; note 1	–	–	–25	dBc
$VSWR_{in}$	input VSWR	$P_L = 18\text{ W}$; note 1	–	1.5 : 1	3 : 1	
	stability	$VSWR \leq 3 : 1$; $P_L = 2\text{ to }20\text{ W}$; $V_{S1} = V_{S2} = 10.8\text{ to }15.6\text{ V}$; note 1	–	–	–60	dBc
	ruggedness	$VSWR = 50 : 1$; $V_{S1} = V_{S2} = 15.6\text{ V}$; $P_L < 25\text{ W}$ during 1 minute; note 1	no degradation			

Note

1. Adjust P_D for specified P_L .

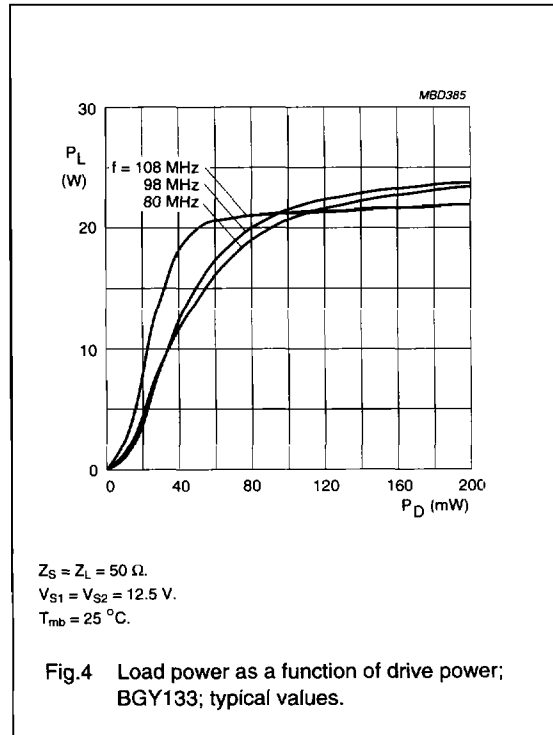
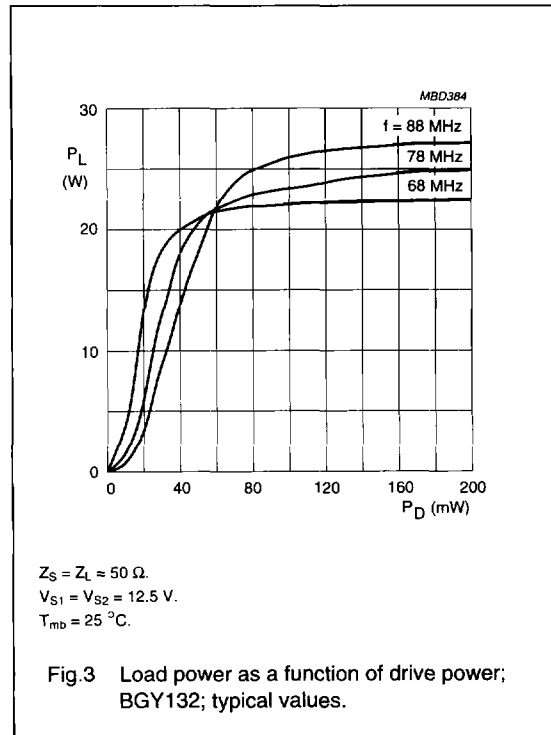

VHF amplifier modules

BGY132; BGY133

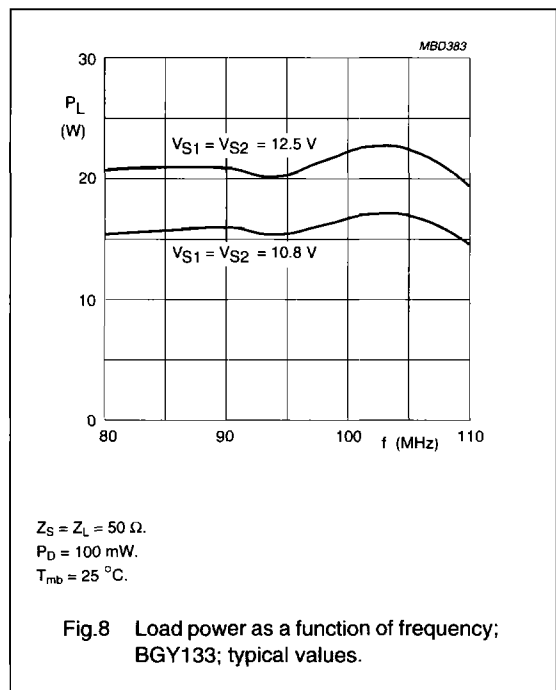
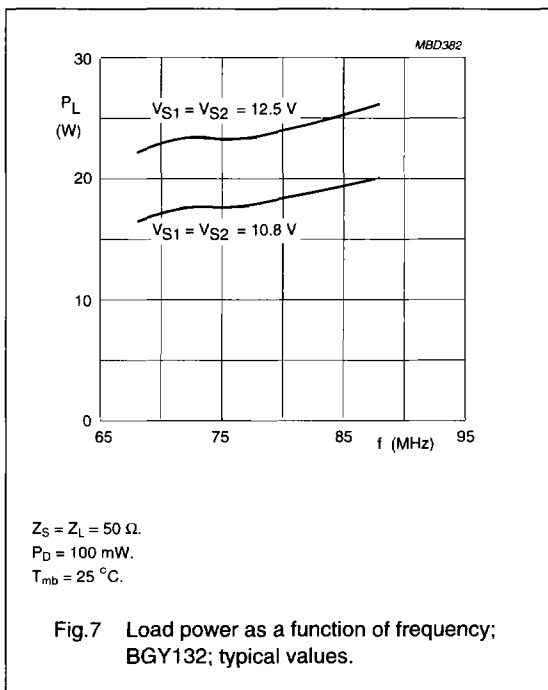
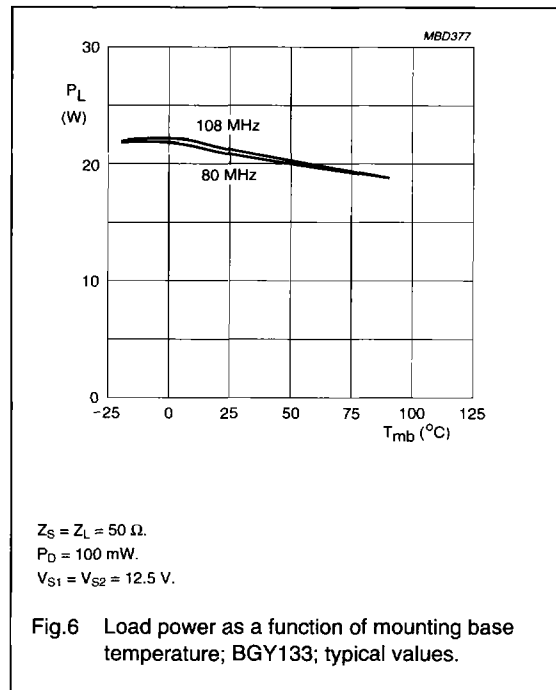
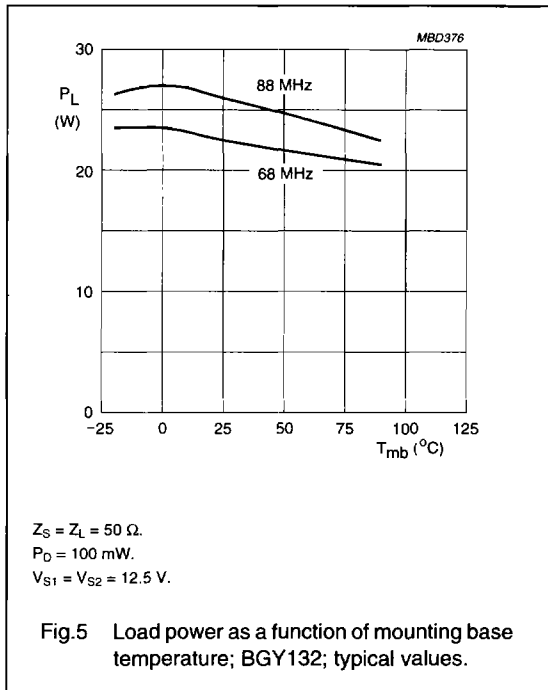

VHF amplifier modules

BGY132; BGY133

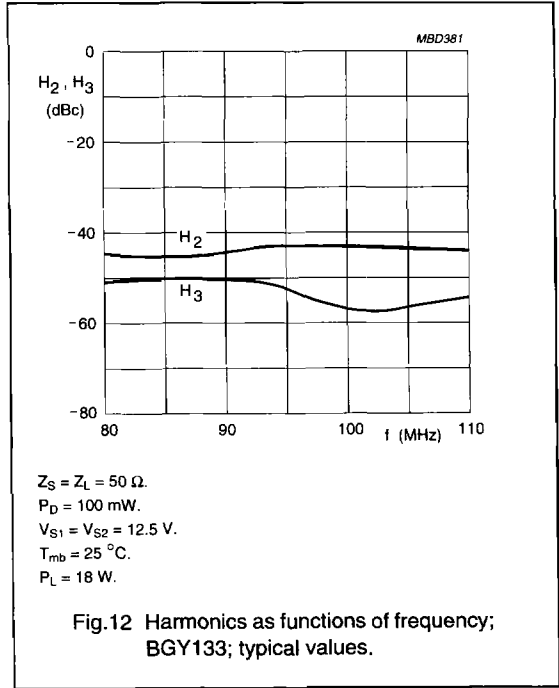
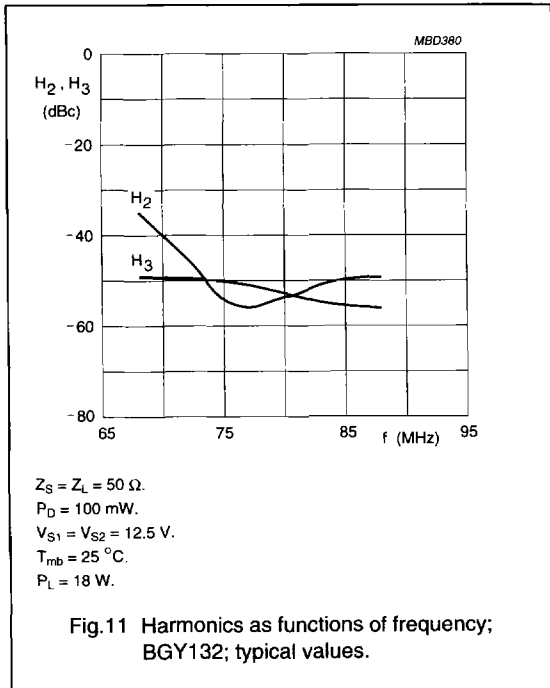
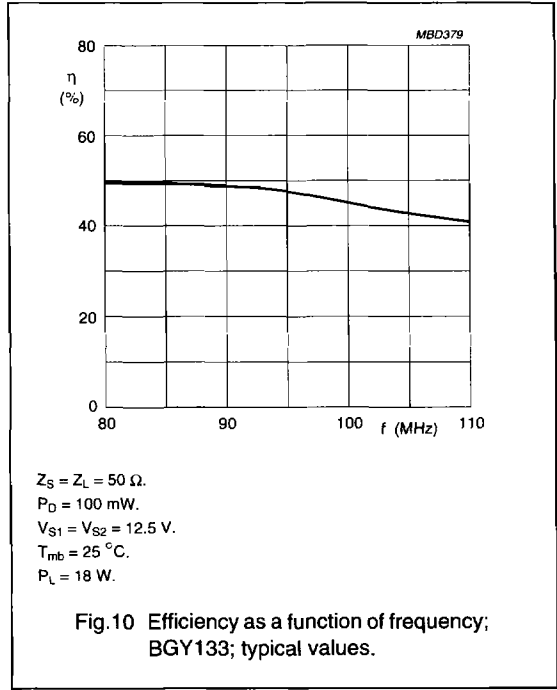
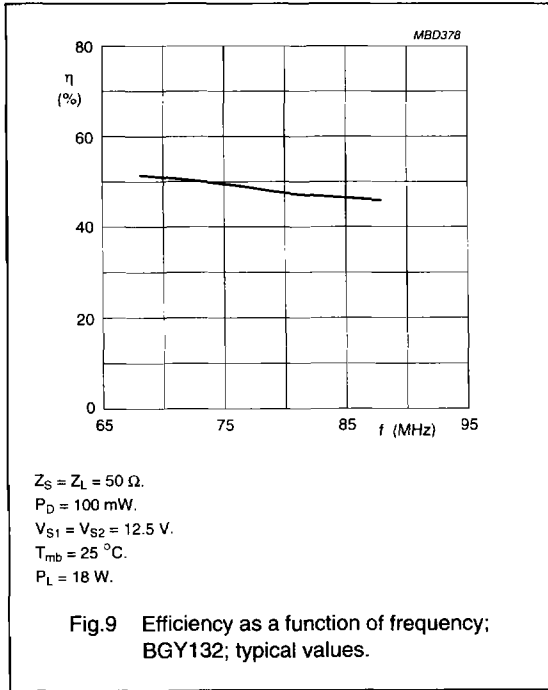

VHF amplifier modules

BGY132; BGY133

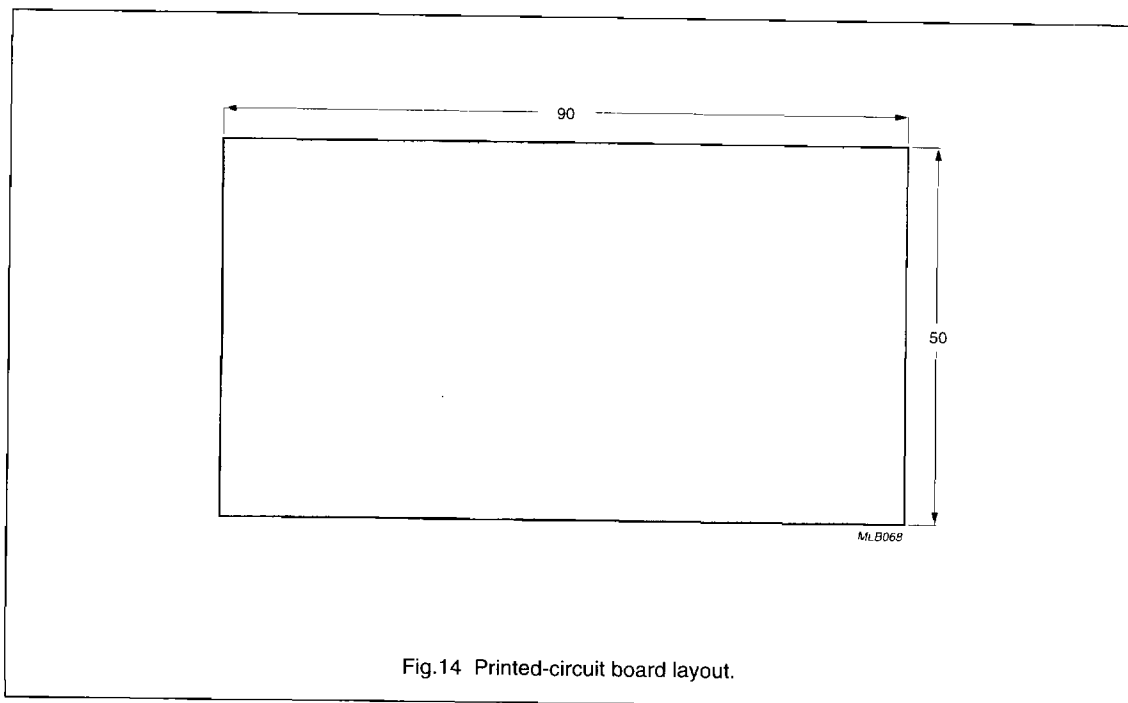
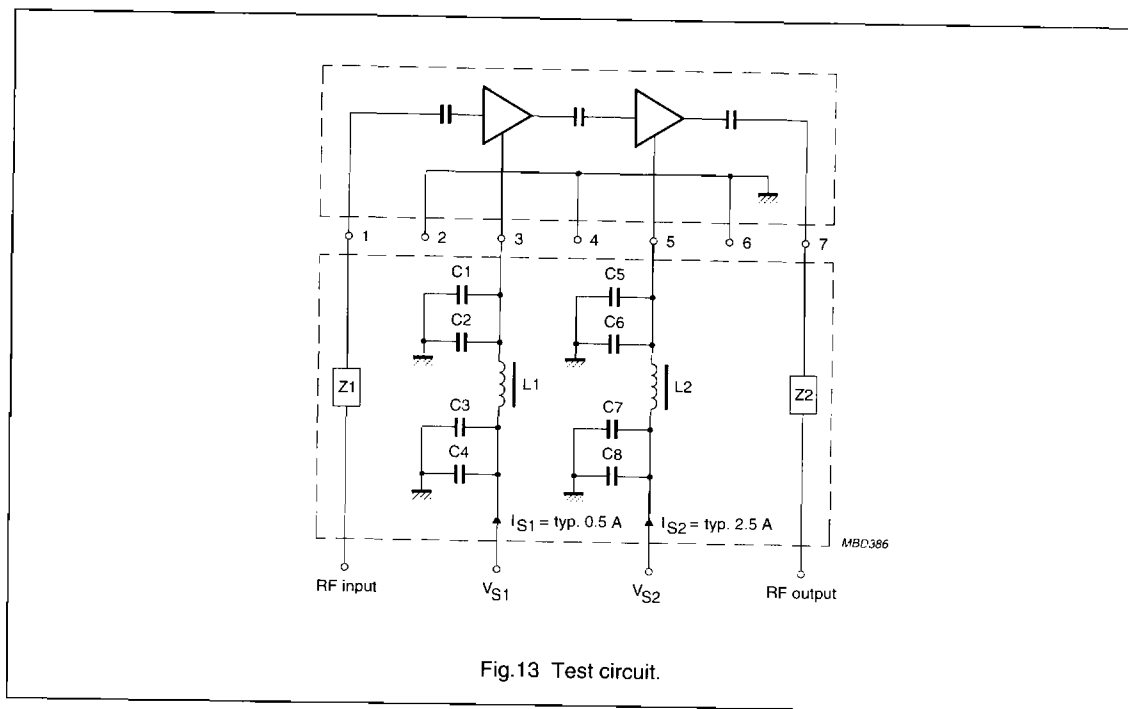

VHF amplifier modules

BGY132; BGY133

List of components (see Fig.13)

COMPONENT	DESCRIPTION	VALUE	CATALOGUE NO.
C1, C5	multilayer ceramic chip capacitor	1 nF	4822 590 06614
C2, C6	tantalum capacitor	6.8 μ F; 35 V	2022 001 00067
C3, C7	multilayer ceramic chip capacitor	10 nF	2222 852 47103
C4, C8	multilayer ceramic chip capacitor	100 nF	2222 852 47104
L1, L2	1 turn 0.5 mm Cu wire on ferrite coil	1 μ H	3122 108 20153
Z1, Z2	stripline; note 1	50 Ω	

Note

1. The striplines are on a double copper-clad printed-circuit board with epoxy dielectric ($\epsilon_r = 4.7$); thickness $\frac{1}{16}$ inch.