

## MECHANICAL DATA

Dimensions in mm(inches)

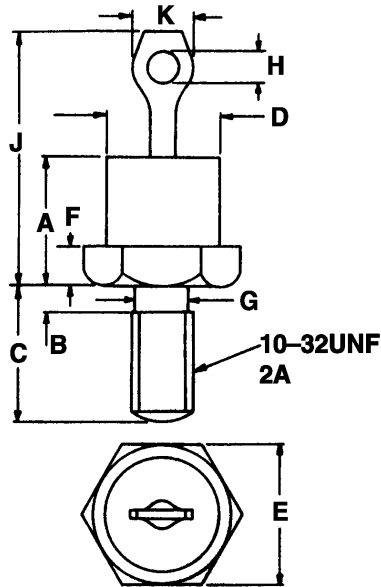

Dim.	Min.	Nom.	Max.
A	–	–	10.28
B	–	–	1.80
C	10.72	–	11.50
D	–	–	10.77Ø
E	10.80Ø	–	11.10Ø
F	–	–	4.40
G	4.20Ø	–	4.80Ø
H	1.60Ø	–	1.80Ø
J	–	–	20.32
K	–	–	6.35

## VOLTAGE REGULATOR DIODES

### FEATURES

The BZY93 series is a range of medium power silicon voltage regulator diodes for general purpose use in a DO-4 outline metal case encapsulation for stud mounting.

Both polarity types are available, BZY93C having stud cathode and BZY93C–R having stud anode.

## ABSOLUTE MAXIMUM RATINGS

$I_{ZM}^{max.}$		20A
$I_{FRM}^{max.}$		15A
$I_{F(AV)}^{max.}$	Averaged over any 20ms period	5A
$P_{TOT}^{max.}$	$T_{MB} = 75^{\circ}C$	20W
	$T_{MB} = 100^{\circ}C$	15W
$P_{Z(sur)}^{max.}$	$T_{MB} = 75^{\circ}C$	500W
$T_{STG}$	Storage Temperature Range	$-55$ to $+175^{\circ}C$
$T_{Jmax.}$	Maximum Junction Temperature	$175^{\circ}C$
$R_{\theta JA}$	Thermal Resistance Junction to Ambient	$5^{\circ}C/W$
$R_{\theta J-MB}$	Thermal Resistance Junction to Mounting Base	$50^{\circ}C/W$
$R_{\theta MB-H}$	Thermal Resistance Mounting Base to Heatsink	$0.6^{\circ}C/W$
	Derating factor $T_{MB} > 75^{\circ}C$	$0.2W/^{\circ}C$

**ELECTRICAL CHARACTERISTICS ( $T_{mb} = 25^{\circ}\text{C}$ ) UNLESS OTHERWISE STATED**

Product	Test $I_Z$ (A)	$V_Z^1$ @ Test $I_Z$ (V)		$R_Z^1$ @ Test $I_Z$ ( $\Omega$ )		$S_Z^1$ (mV/ $^{\circ}\text{C}$ )	$I_R$ ( $\mu\text{A}$ )	At	$V_R$ (V)
		Min.	Max.	Typ.	Max.	Typ.	Max.		
C6V8	2.0	6.4	7.2	0.04	0.2	2.5	100		2.0
C7V5	2.0	7.0	7.9	0.04	0.3	3.0	100		2.0
C8V2	2.0	7.7	8.7	0.05	0.3	4.0	100		5.6
C9V1	1.0	8.5	9.6	0.07	0.5	5.0	50		6.2
C10	1.0	9.4	10.6	0.07	0.5	7.0	50		6.8
C11	1.0	10.4	11.6	0.08	1.0	7.5	50		7.5
C12	1.0	11.4	12.7	0.08	1.0	8.0	50		8.2
C13	1.0	12.4	14.1	0.08	1.0	8.5	50		9.1
C15	1.0	13.8	15.6	0.10	1.2	10.0	50		10.0
C16	0.5	15.3	17.1	0.18	1.2	11.0	50		11.0
C18	0.5	16.8	19.1	0.20	1.5	12.0	50		12.0
C20	0.5	18.8	21.2	0.20	1.5	14.0	50		13.0
C22	0.5	20.8	23.3	0.21	1.8	16.0	50		15.0
C24	0.5	22.7	25.9	0.22	2.0	18.0	50		16.0
C27	0.5	25.1	28.9	0.25	2.0	21.0	50		18.0
C30	0.5	28.0	32.0	0.30	2.5	25.0	50		20.0
C33	0.5	31.0	35.0	0.32	3.0	30.0	50		22.0
C36	0.2	34.0	38.0	0.75	4.0	32.0	50		24.0
C39	0.2	37.0	41.0	0.85	5.0	35.0	50		27.0
C43	0.2	40.0	46.0	0.9	6.5	40.0	50		30.0
C47	0.2	44.0	50.0	1.0	7.0	45.0	50		33.0
C51	0.2	48.0	54.0	1.2	7.5	50.0	50		36.0
C56	0.2	52.0	60.0	1.3	8.0	55.0	50		39.0
C62	0.2	58.0	66.0	1.5	9.0	60.0	50		43.0
C68	0.2	64.0	72.0	1.8	10.0	65.0	50		47.0
C75	0.2	70.0	79.0	2.0	10.5	70.0	50		51.0

**Notes**

1. Pulse Test:  $t_p \leq 100\mu\text{s}$ ,  $\delta \leq 0.1\%$ .

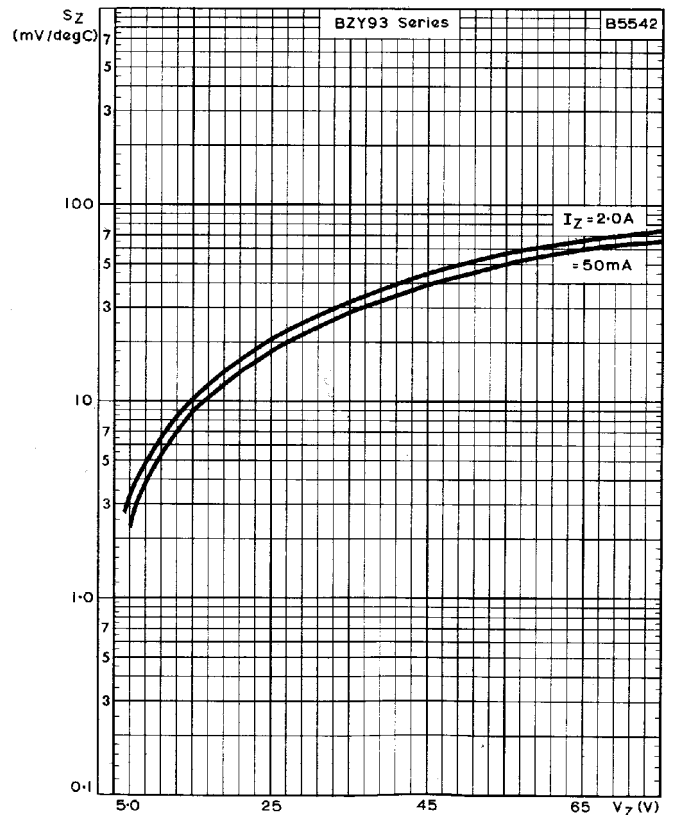
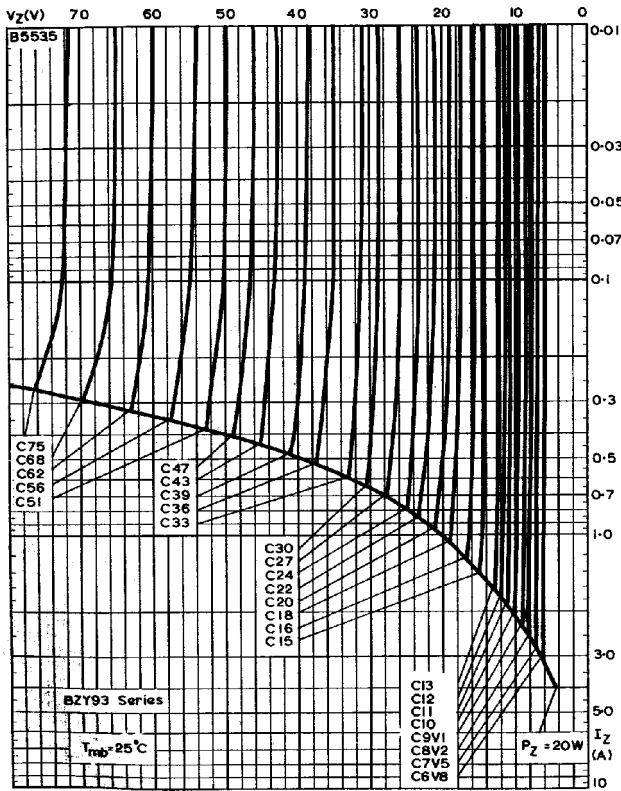

TYPICAL STATIC ZENER CHARACTERISTICS

TYPICAL TEMPERATURE COEFFICIENT vs ZENER VOLTAGE

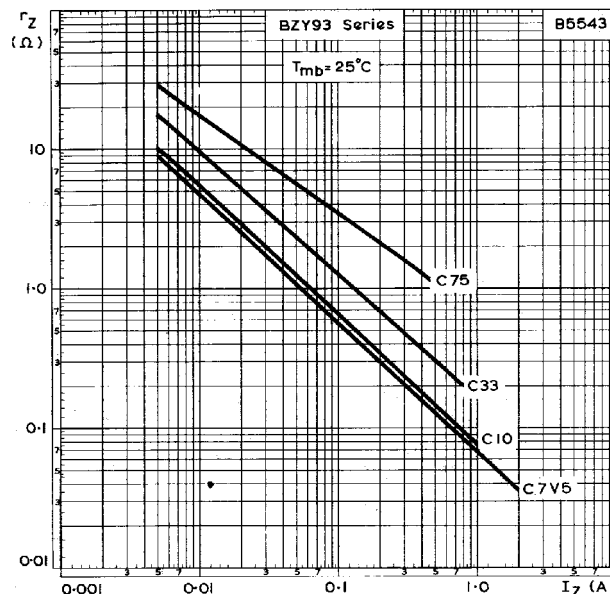

TYPICAL DYNAMIC IMPEDANCE vs ZENER CURRENT

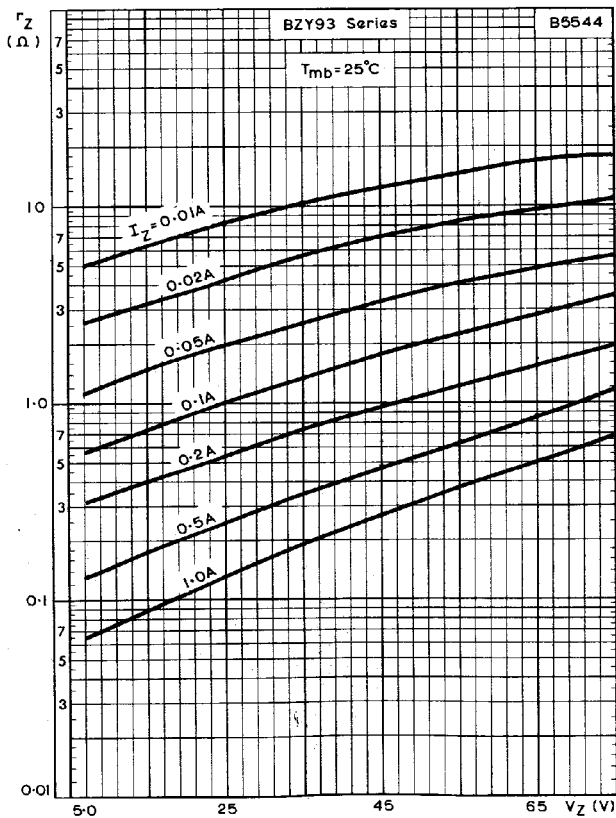

**TYPICAL DYNAMIC IMPEDANCE vs ZENER VOLTAGE**

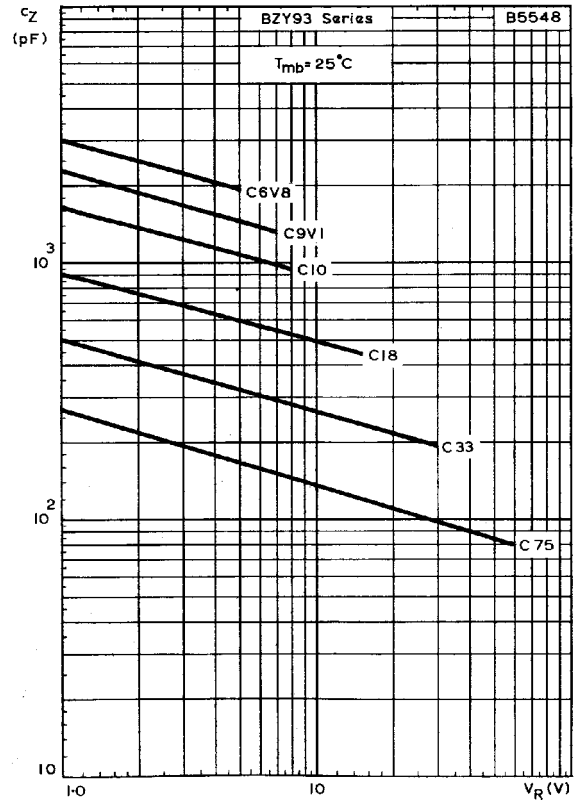

**TYPICAL ZENER CAPACITANCE vs REVERSE VOLTAGE**

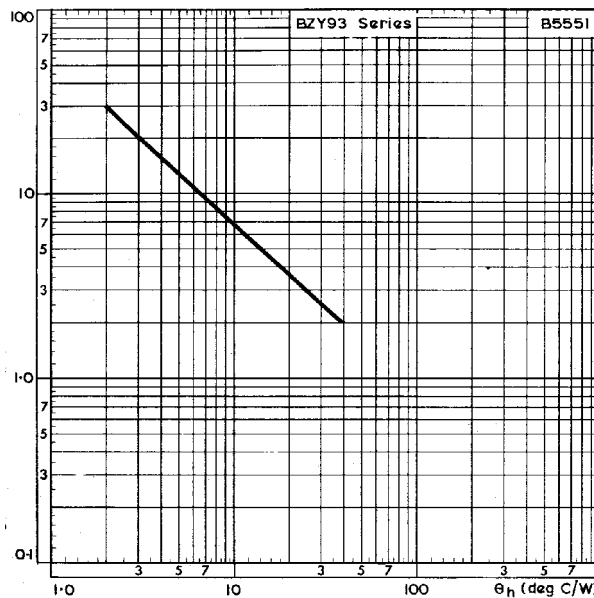

**THERMAL RESISTANCE vs SQUARE SIDE VERTICALLY MOUNTED HEATSINK OF 16 s.w.g. (1.625mm) NORMAL BRIGHT FINISH.**

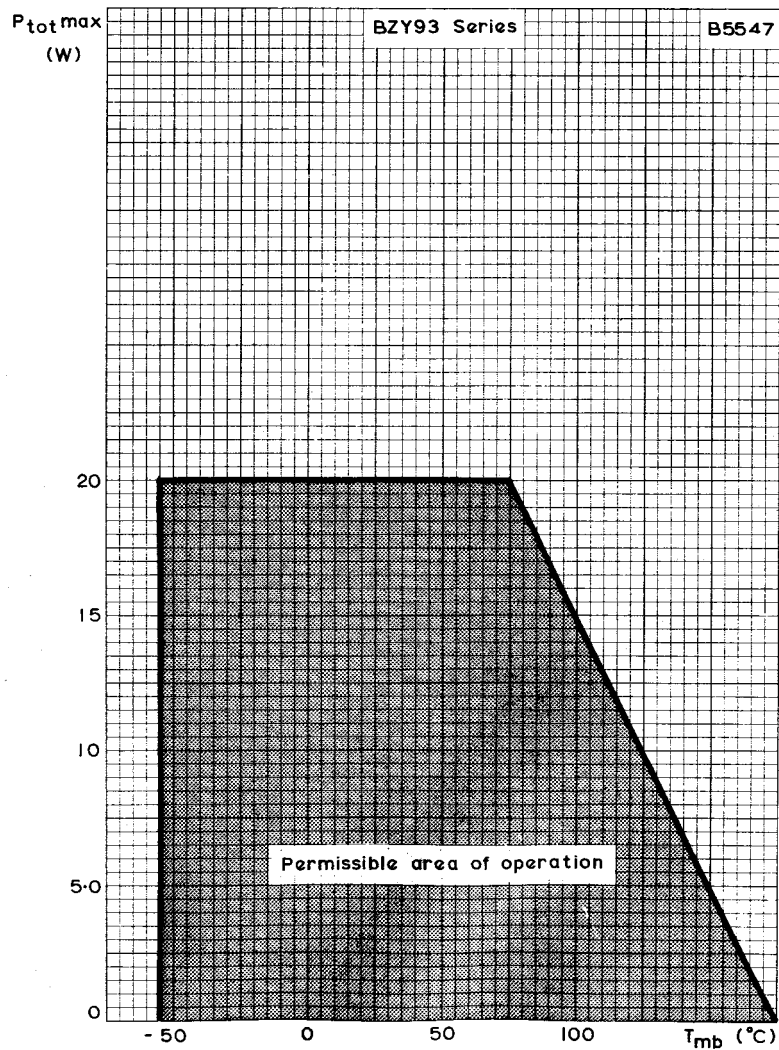

**MAXIMUM TOTAL DISSIPATION vs MOUNTING BASE TEMPERATURE**

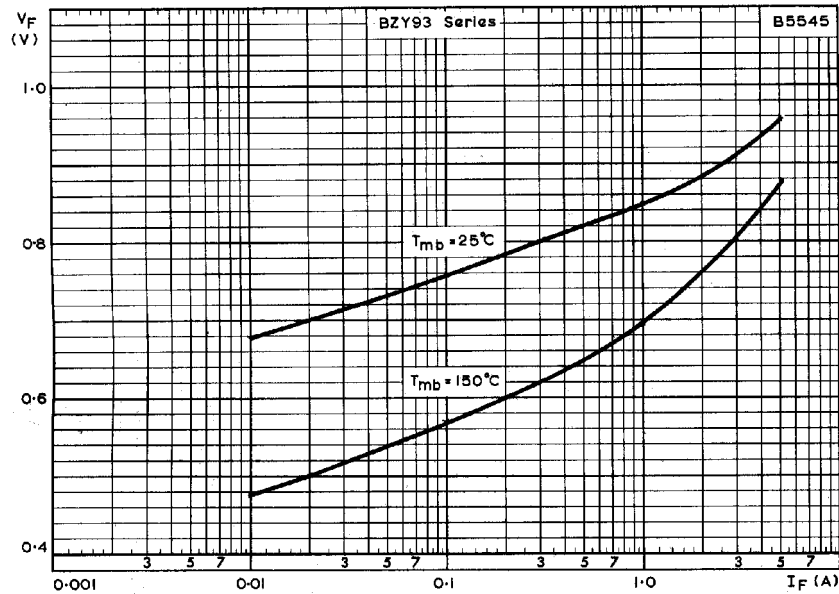

TYPICAL DYNAMIC FORWARD CHARACTERISTICS

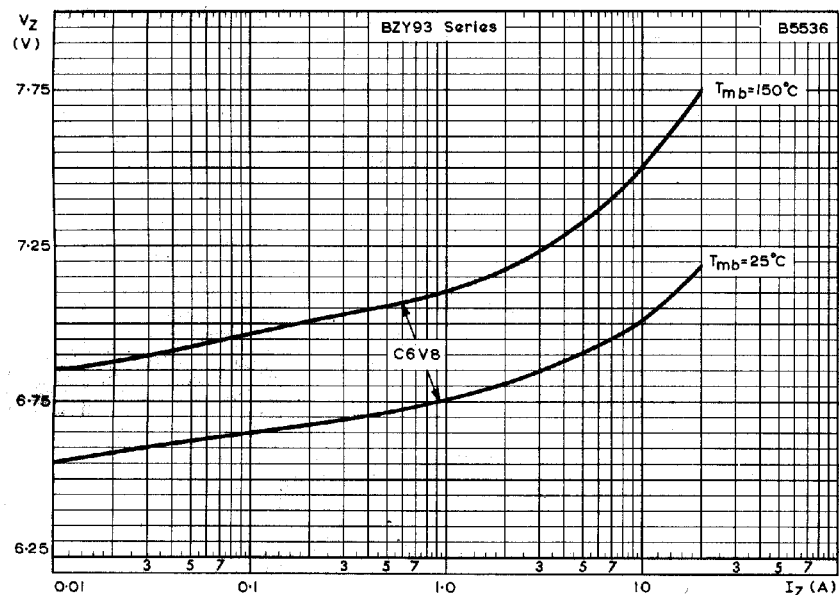

TYPICAL DYNAMIC ZENER CHARACTERISTICS FOR 6.8V DEVICE

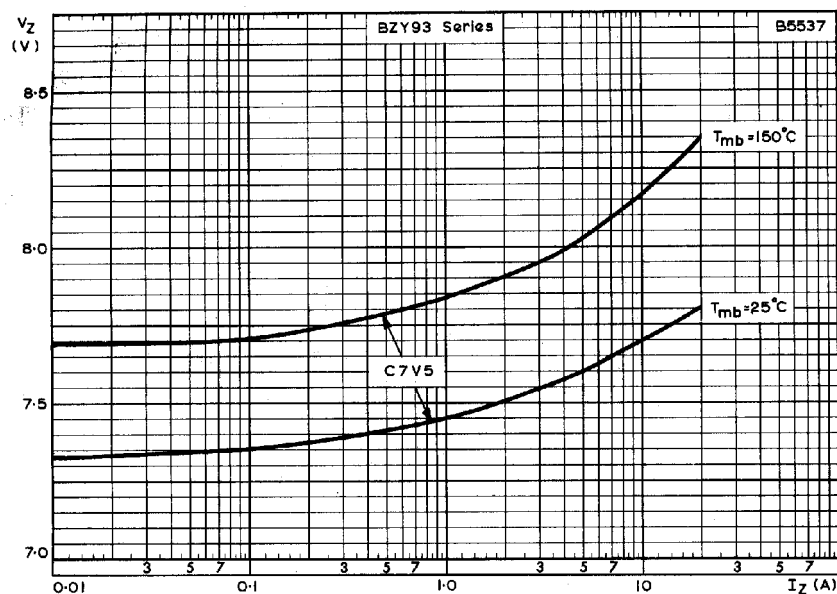

**TYPICAL DYNAMIC ZENER CHARACTERISTICS FOR 7.5V DEVICE**

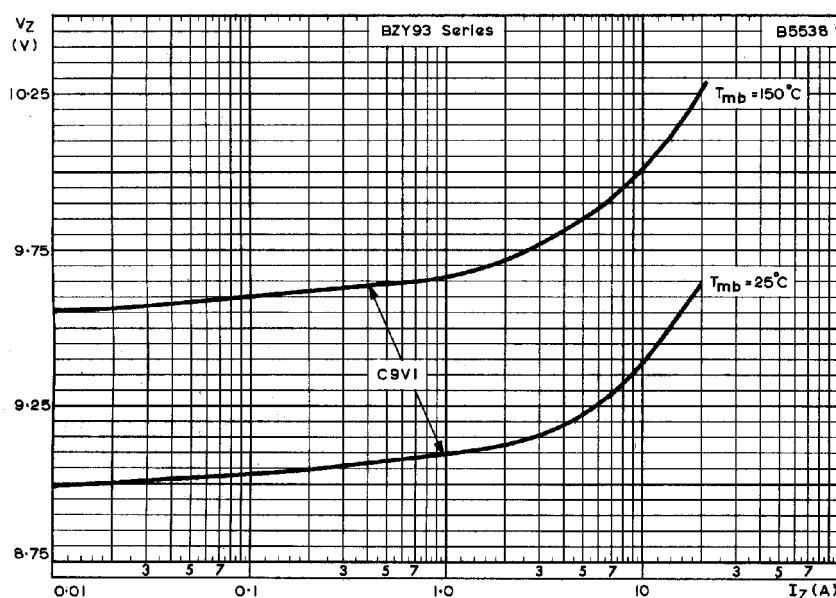

**TYPICAL DYNAMIC ZENER CHARACTERISTICS FOR 9.1V DEVICE**

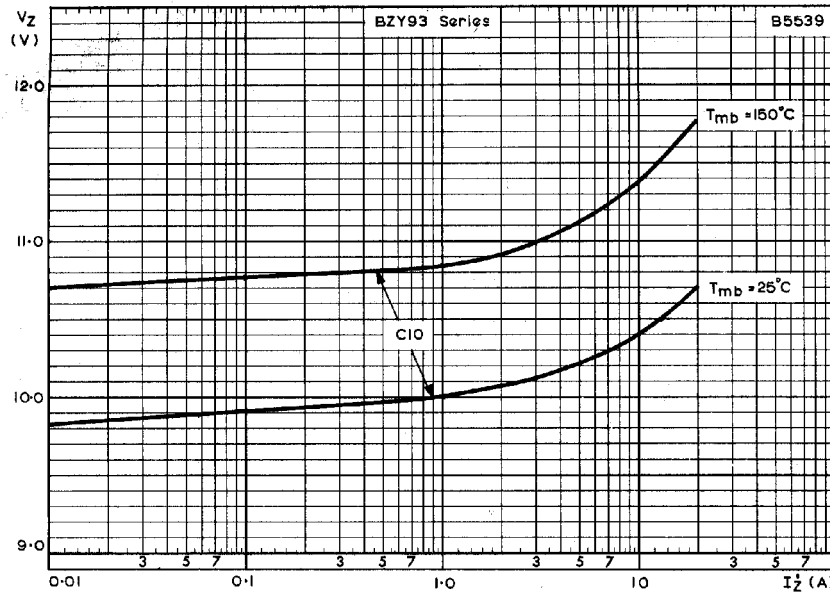

**TYPICAL DYNAMIC ZENER CHARACTERISTICS FOR 10V DEVICE**

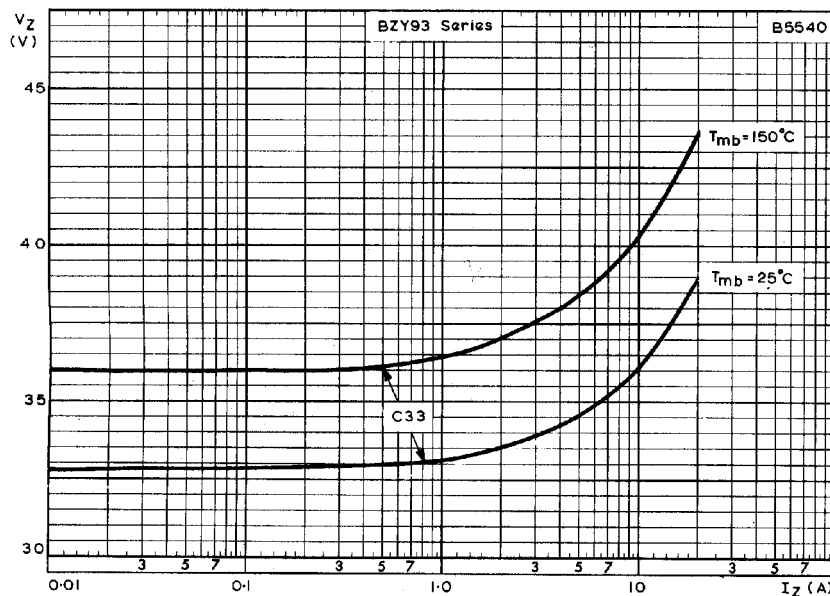

**TYPICAL DYNAMIC ZENER CHARACTERISTICS FOR 33V DEVICE**



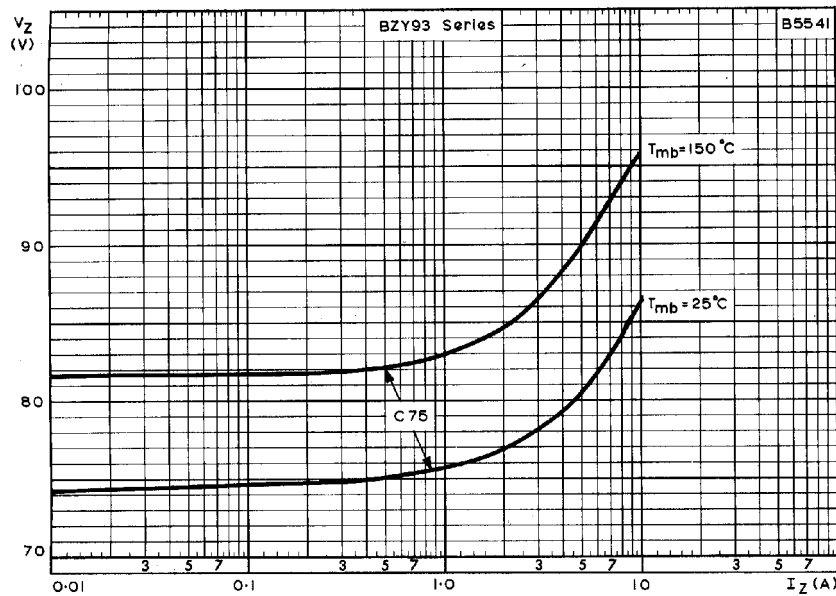

**TYPICAL DYNAMIC ZENER CHARACTERISTICS FOR 75V DEVICE**

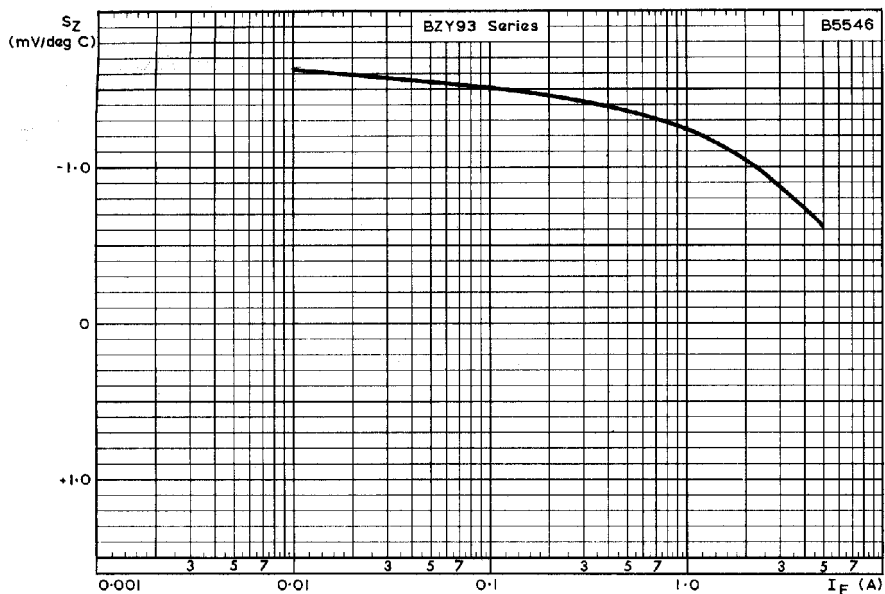

**TYPICAL FORWARD VOLTAGE TEMPERATURE COEFFICIENT vs FORWARD CURRENT**

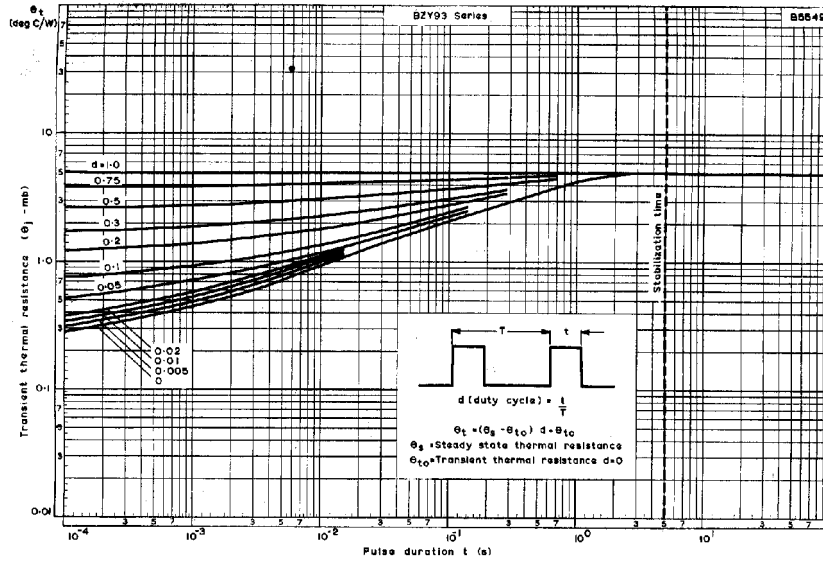

TRANSIENT THERMAL RESISTANCE FOR VARIOUS DUTY FACTORS vs PULSE DURATION

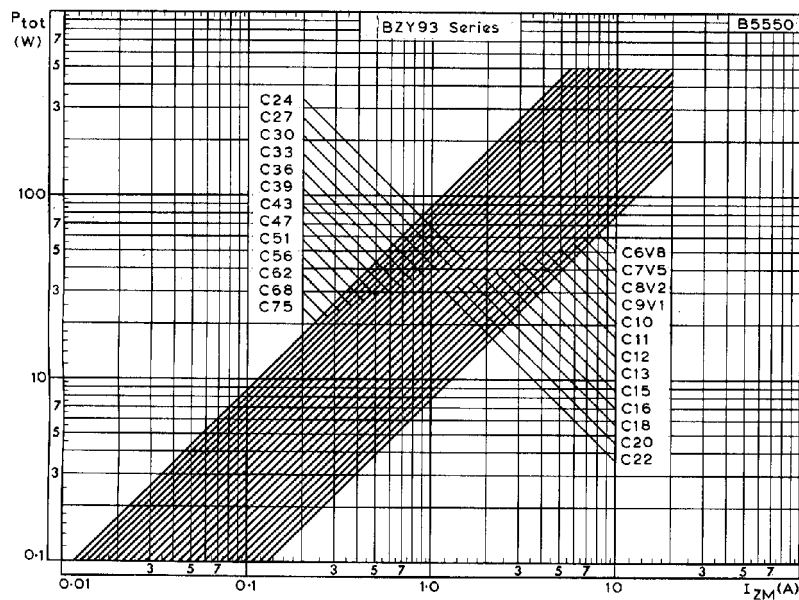

MAXIMUM ZENER DISSIPATION vs ZENER CURRENT