

MGA-31589

0.5 W High Gain Driver Amplifier



Data Sheet

Description

Avago Technologies' MGA-31589 is a 0.5 W, high Gain, high performance Driver Amplifier MMIC, housed in a standard SOT-89 plastic package. The device required simple matching components to achieve optimum performance within specific 100 to 200 MHz bandwidth.

MGA-31589 is especially ideal for wireless infrastructure applications that operate within the 450 MHz to 1.5 GHz frequency range. With high IP3 and low noise figure, the MGA-31589 may be utilized as a driver amplifier in the transmit chain and as second or third stage LNA in the receive chain. For optimum performance at higher frequency from 1.5 GHz to 3.0 GHz, MGA-31689 is recommended.

MGA-31589's high gain and high linearity features are achieved through the use of Avago Technologies' proprietary 0.25 μm GaAs Enhancement-mode pHEMT process.

Pin connections and Package Marking

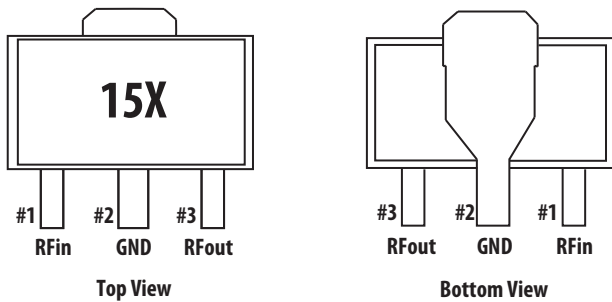

Note:
 Top View: Package marking provides orientation and identification
 "15" = Device Code
 "X" = Date Code character identifies month of manufacturing



Attention: Observe precautions for handling electrostatic sensitive devices.
 ESD Machine Model = 150 V
 ESD Human Body Model = 650 V
 Refer to Avago Application Note A004R:
 Electrostatic Discharge, Damage and Control.

Features

- ROHS compliant
- Halogen free
- High linearity at low DC bias power^[1]
- High Gain
- Low noise figure
- High OIP3
- Advanced enhancement mode PHEMT Technology
- Excellent uniformity in product specification
- SOT-89 standard package

Specifications

At 0.9 GHz, Vdd = 5 V, Idd = 146 mA (typical) at 25° C

- OIP3 = 45.3 dBm
- Noise Figure = 1.9 dB
- Gain = 20.4 dB
- P1dB = 27.2 dBm
- IRL = 14.0 dB, ORL = 11.6 dB

Note:
 1. The MGA-31589 has a superior LFOM of 16. Linearity Figure of Merit (LFOM) is essentially OIP3 divided by DC bias power.

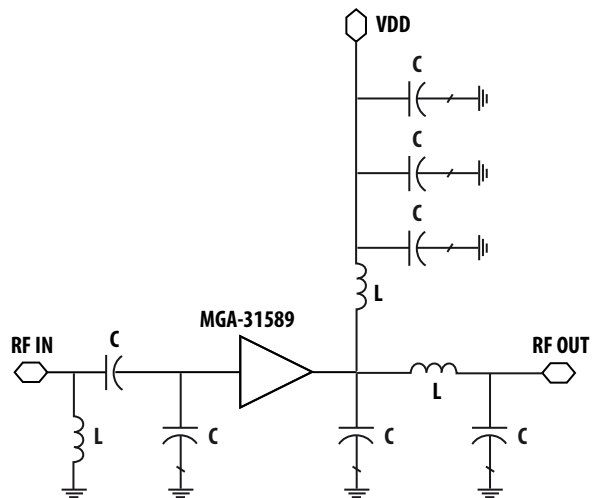

Figure 1. Simplified Schematic diagram

MGA-31589 Absolute Maximum Rating [1]

Symbol	Parameter	Units	Absolute Max.
$V_{dd, max}$	Drain Voltage, RF output to ground	V	5.5
P_d	Power Dissipation (2)	mW	1050
P_{in}	CW RF Input Power	dBm	17
T_j	Junction Temperature	°C	150
T_{STG}	Storage Temperature	°C	-65 to 150

Thermal Resistance

Thermal Resistance [3]

($V_{dd} = 5.0$ V, $I_{dd} = 146$ mA, $T_c = 85^\circ$ C),
 $\theta_{jc} = 44^\circ$ C/W

Notes:

1. Operation of this device in excess of any of these limits may cause permanent damage.
2. Source lead temperature is 25° C. Derate 22.7 mW/° C for $T_L > 103.8^\circ$ C.
3. Thermal resistance measured using 150° C Infra-Red Microscopy Technique.

MGA-31589 Electrical Specification [1]

$T_c = 25^\circ$ C, $Z_o = 50 \Omega$, $V_{dd} = 5$ V, unless specified.

Symbol	Parameter and Test Condition	Frequency	Units	Min.	Typ.	Max.
		(MHz)				
I_{ds}	Quiescent Current	NA	mA	115	146	175
NF	Noise Figure	700	dB		2.35	2.8
		900			1.92	
Gain	Gain	700	dB	19.3	20.5	22.0
		900			20.4	
OIP3	Output Third Order Intercept Point	700 [2]	dBm	40.0	45.2	
		900 [2]			45.3	
P1dB	Output Power at 1 dB Gain Compression	700	dBm	26.3	26.4	
		900			27.2	
PAE	Power Added Efficiency at P1dB	700	%		43.6	
		900			45.0	
IRL	Input Return Loss	700	dB		20.0	
		900			14.0	
ORL	Output Return Loss	700	dB		10.4	
		900			11.6	
ISOL	Isolation	700	dB		28.0	
		900			27.5	

Note :

1. Measurements obtained from a test circuit described in Figure 27.
2. OIP3 test condition: $F1 - F2 = 1.0$ MHz, with input power of -8 dBm per tone measured at worst case side band.

MGA-31589 Consistency Distribution Chart [1,2]

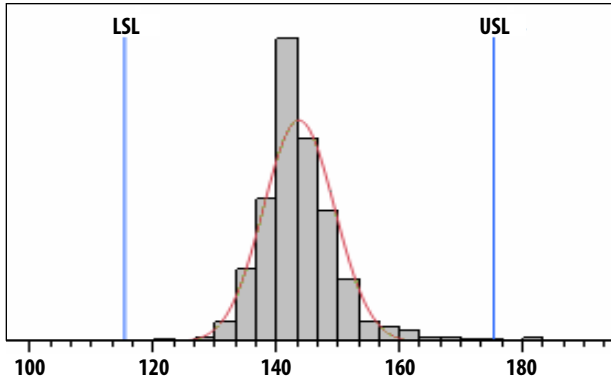

Figure 2. Idd at Vdd = 5 V, LSL = 115 mA, Nominal = 146 mA, USL = 175 mA

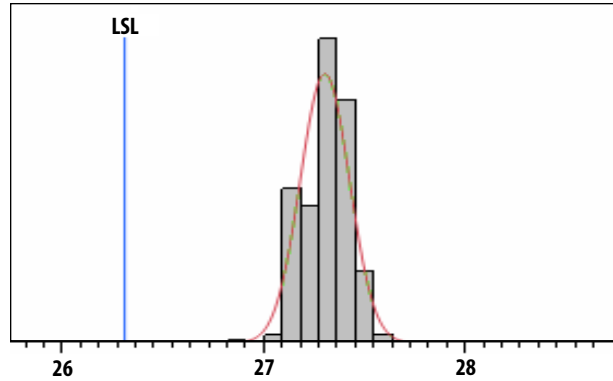

Figure 3. OP1dB at 900 MHz, Vdd = 5 V, LSL = 26.3 dBm, Nominal = 27.2 dBm

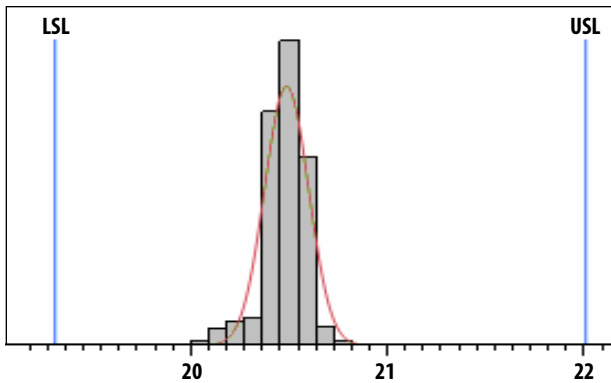

Figure 4. Gain at 900 MHz, Vdd = 5 V, LSL = 19.3 dB, Nominal = 20.4 dB, USL = 22.0 dB

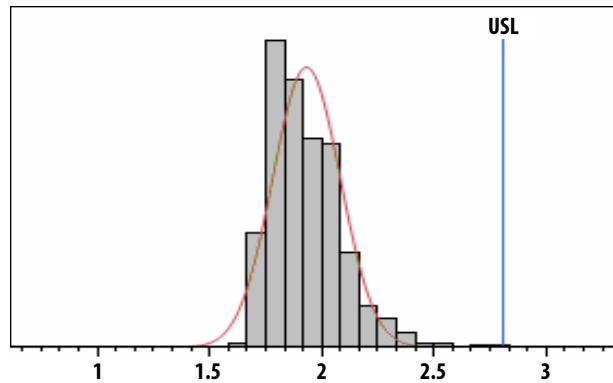

Figure 5. NF at 900 MHz, Vdd = 5 V, Nominal = 1.92 dB, USL = 2.8 dB

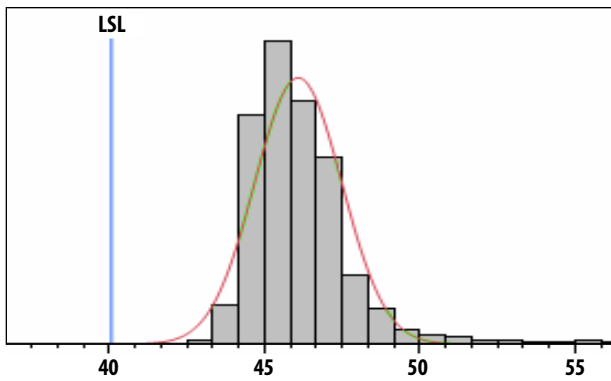

Figure 6. OIP3 at 900 MHz, Vdd = 5 V, LSL = 40.0 dBm, Nominal = 45.3 dBm

Notes:

1. Data sample size is 2500 samples taken from 5 wafers and 3 different wafer lots. Future wafers allocated to this product may have nominal values anywhere between the upper and lower limits.
2. Measurements are made on production test board which represents a trade off between nominal Gain, NF, OIP3, and OP1dB. Circuit losses have been de-embedded from actual measurements.

MGA-31589 Application Circuit Data for 700 MHz

$T_A = 25^\circ\text{C}$, $V_{dd} = 5\text{V}$, $I_{dd} = 146\text{mA}$

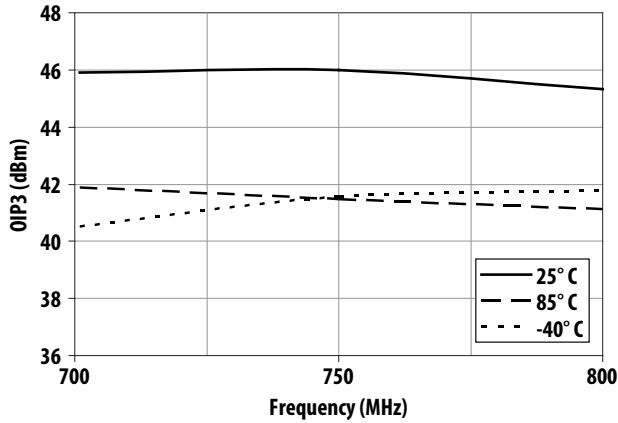

Figure 7. Over Temperature OIP3 vs Frequency

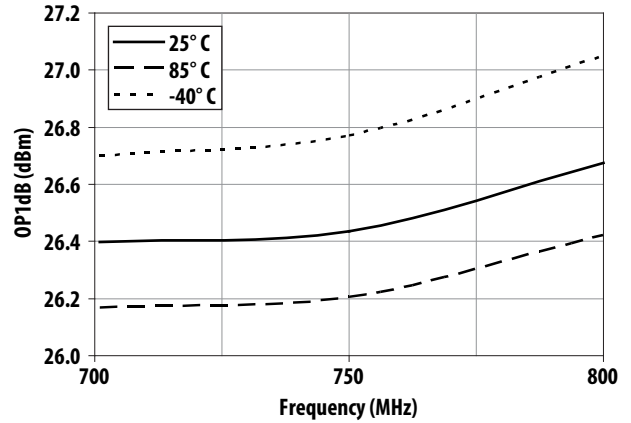

Figure 8. Over Temperature OP1dB vs Frequency

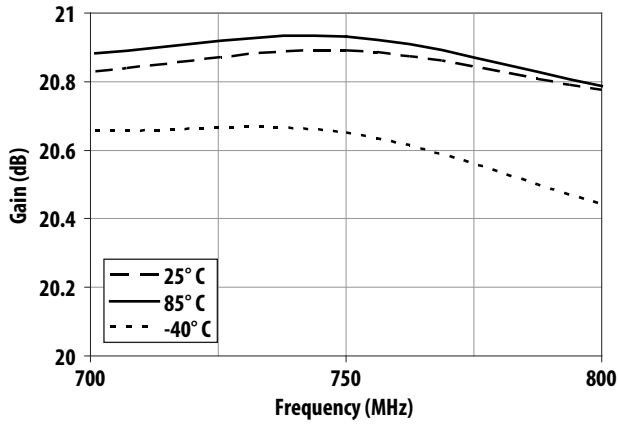

Figure 9. Over Temperature Gain vs Frequency

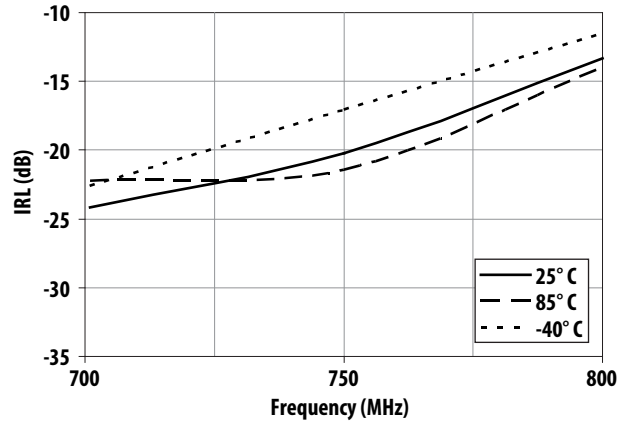

Figure 10. Over Temperature IRL vs Frequency

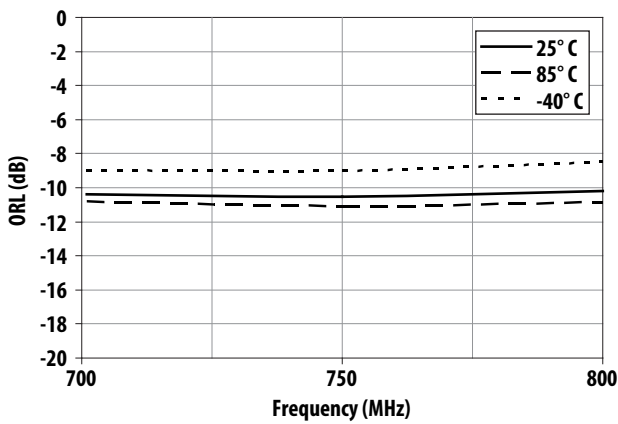

Figure 11. Over Temperature ORL vs Frequency

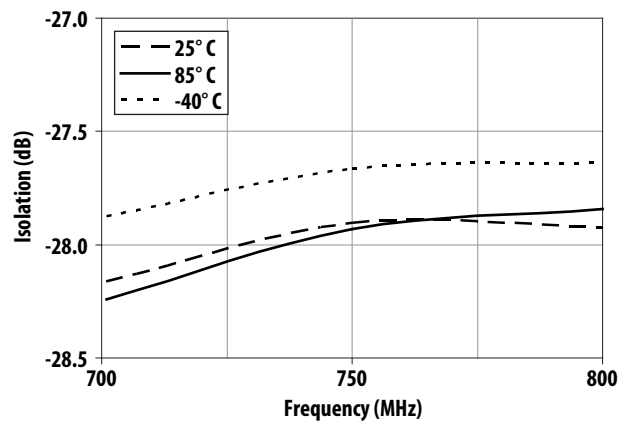

Figure 12. Over Temperature Isolation vs Frequency

MGA31589 Application Circuit Data for 700 MHz (continued)

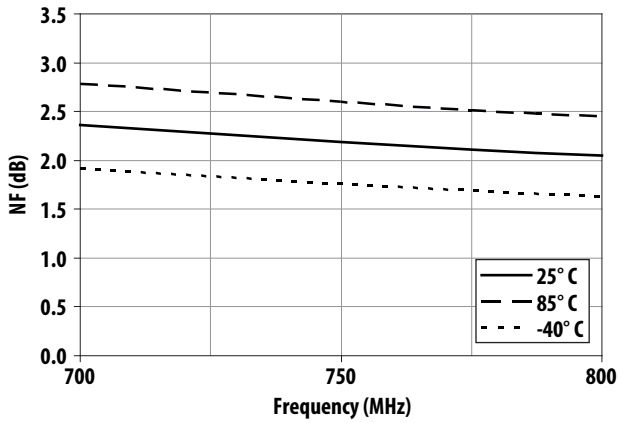

Figure 13. Over Temperature Noise Figure vs Frequency

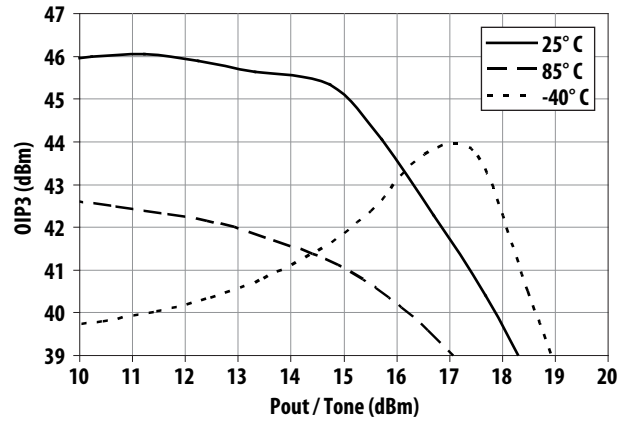

Figure 14. Over Temperature OIP3 at 700 MHz vs Pout

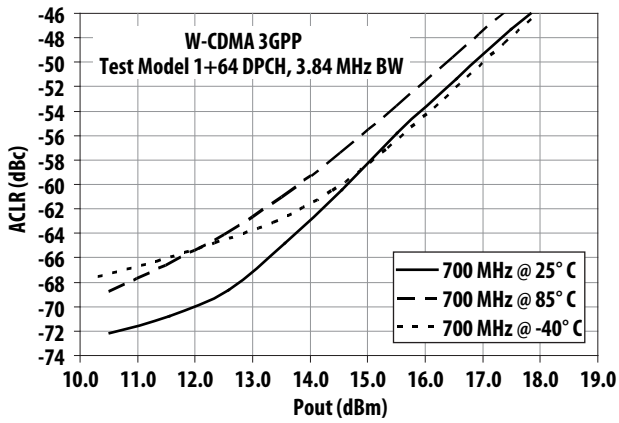

Figure 15. Over Temperature ACLR vs Pout at 700 MHz

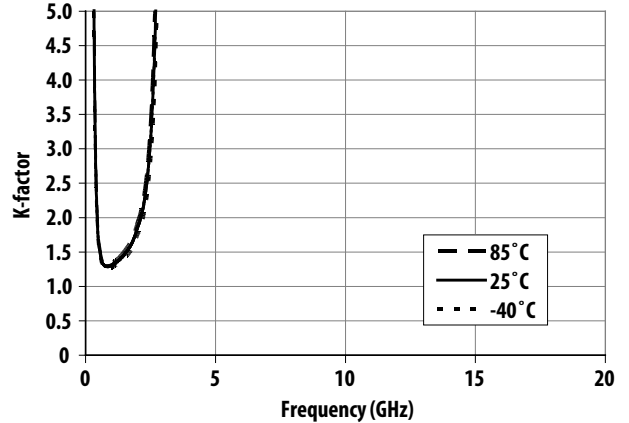

Figure 16. Over Temperature K-factor vs Frequency

MGA-31589 Application Circuit Data for 900 MHz

$T_A = 25^\circ\text{C}$, $V_{dd} = 5\text{V}$, $I_{dd} = 146\text{mA}$

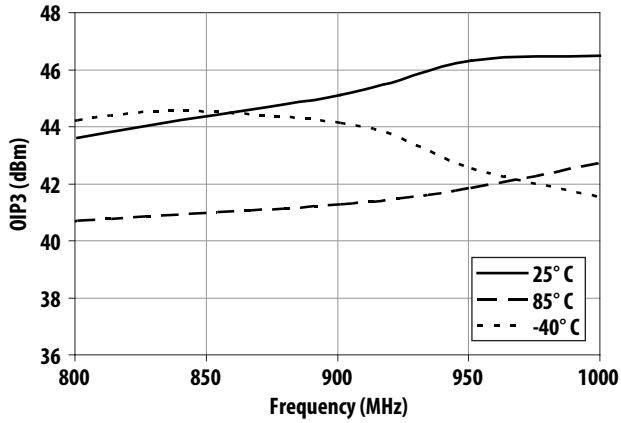

Figure 17. Over Temperature OIP3 vs Frequency

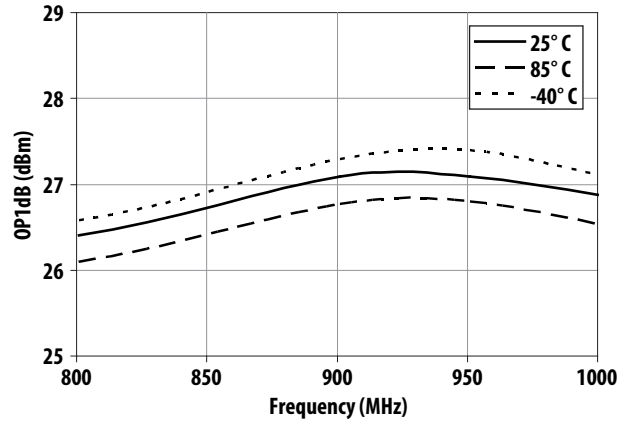

Figure 18. Over Temperature OP1dB vs Frequency

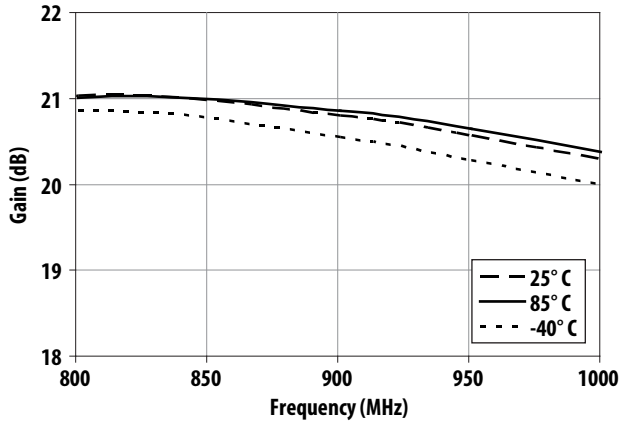

Figure 19. Over Temperature Gain vs Frequency

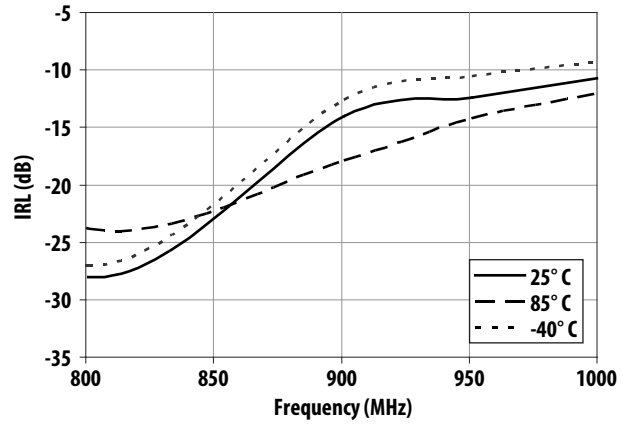

Figure 20. Over Temperature IRL vs Frequency

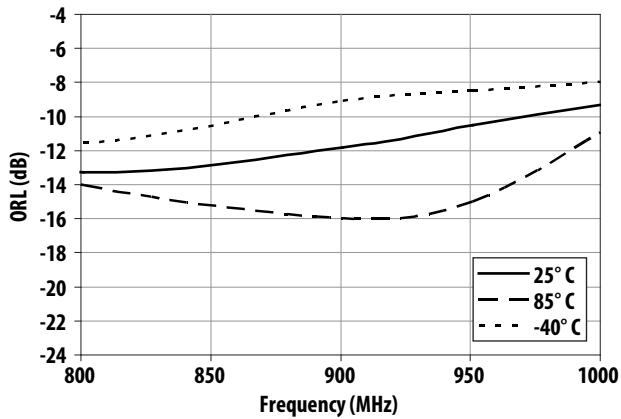

Figure 21. Over Temperature ORL vs Frequency

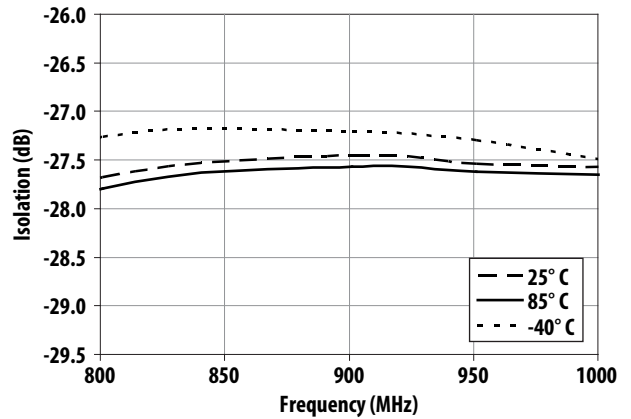

Figure 22. Over Temperature Isolation vs Frequency

MGA-31589 Application Circuit Data for 900 MHz (continued)

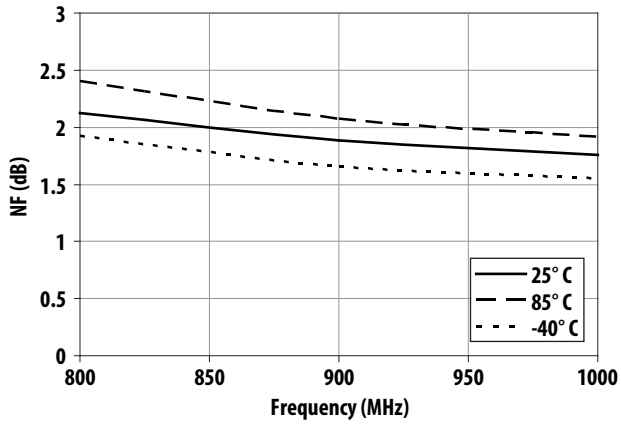

Figure 23. Over Temperature Noise Figure vs Frequency

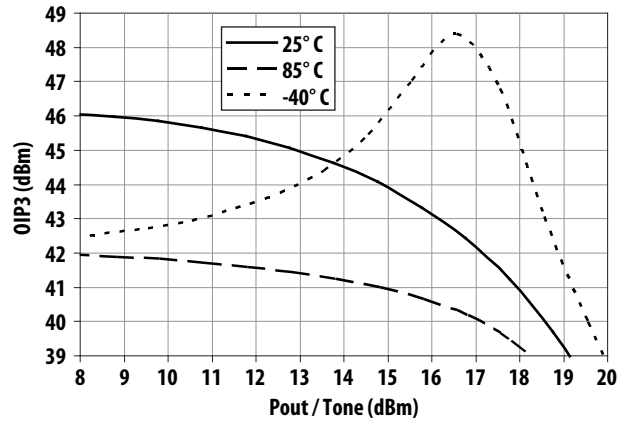

Figure 24. Over Temperature OIP3 vs Pout at 900 MHz

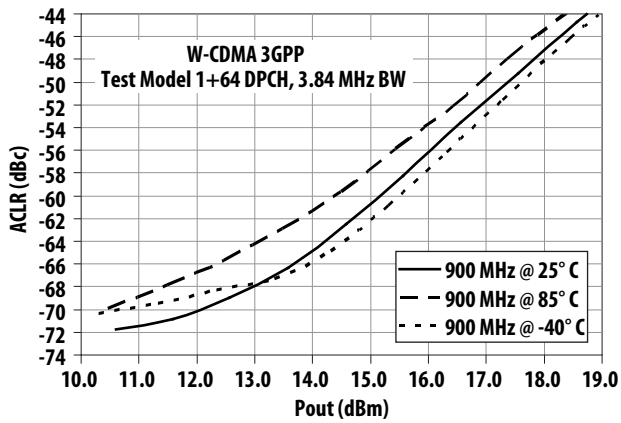

Figure 25. Over Temperature ACLR vs Pout at 900 MHz

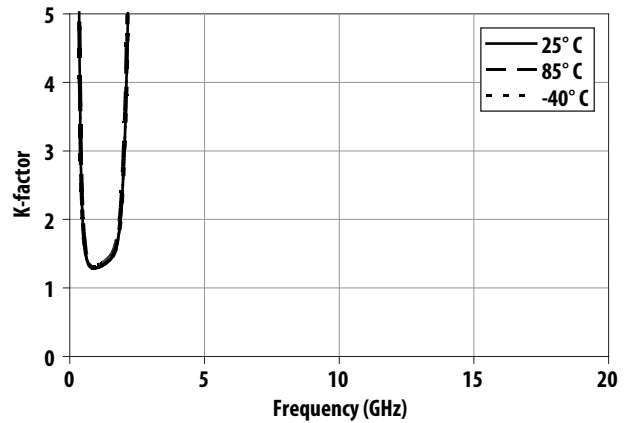

Figure 26. Over Temperature K-factor vs Frequency

Application Circuit Description and Layout

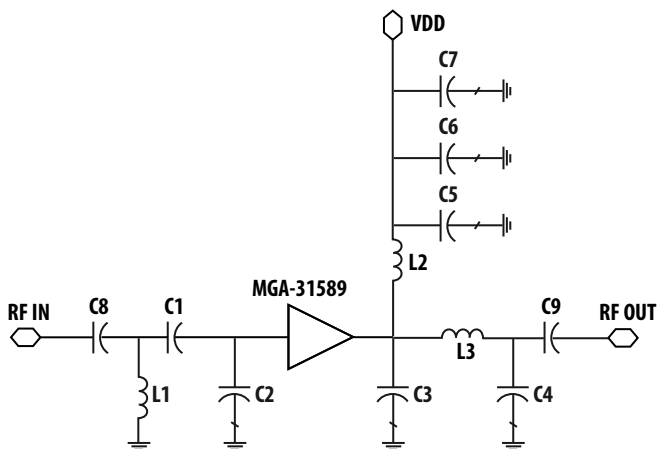

Figure 27. Circuit diagram

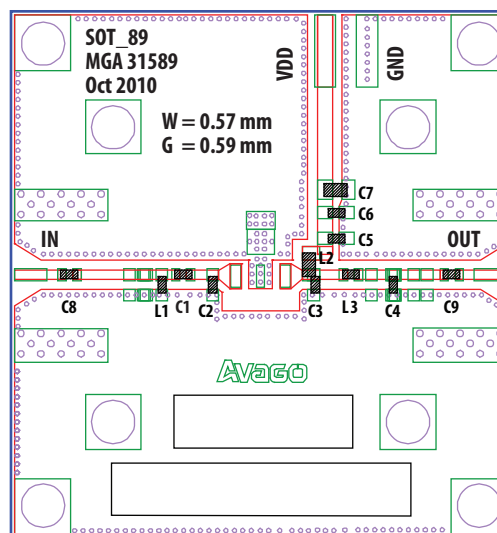

Figure 28. Demo board

Bill of Materials

Circuit Symbol	Size	Description For 700 – 800 MHz			Description For 800 – 1000 MHz		
		Value	Part Number	Manufacturer	Value	Part Number	Manufacturer
C1	0402	6.8 pF	CM05CH6R8C50AH	Kyocera	5.6 pF	CM05CH5R6C50AH	Kyocera
C2	0402	3.3 pF	CM05CH3R3C50AH	Kyocera	5.1 pF	CM05CH5R1C50AH	Kyocera
C3	0402	1.2 pF	CM05CH1R2C50AH	Kyocera	3.9 pF	CM05CH3R9C50AH	Kyocera
C4	0402	3.6 pF	CM05CH3R6C50AH	Kyocera	3.0 pF	GJM1555C1H3R0BB01D	Murata
C5	0402	100 pF	GRM1555C1H101JA01B	Murata	100 pF	GRM1555C1H101JA01B	Murata
C6	0402	0.1 μF	GRM155R71C104KA88D	Murata	0.1 μF	GRM155R71C104KA88D	Murata
C7	0805	2.2 μF	GRM21BR61A225KA01L	Murata	2.2 μF	GRM21BR61A225KA01L	Murata
C8*	0402	100 pF	GRM1555C1H101JA01B	Murata	100 pF	GRM1555C1H101JA01B	Murata
C9*	0402	100 pF	GRM1555C1H101JA01B	Murata	100 pF	GRM1555C1H101JA01B	Murata
L1	0402	5.6 nH	MLK1005S5N6DT000	TDK	5.6 nH	LLP1005-FH5N6C	Toko
L2	0603	22 nH	0603CS-22NXJLW	CoilCraft	22 nH	0603CS-22NXJLW	CoilCraft
L3	0402	2.7 nH	LLP1005-FH2N7C	Toko	4.3 nH	HK10054N3S-T	TaiyoYuden

Note: * as blocking capacitor, not required in actual application circuit.

For best performance, MGA-31589 requires only simple input and output matching network. The C3, C4, and L3 act as the output tuning circuitry for matching and OIP3 optimization. Bandpass network C1, C2, and L1 forms the input matching network. To bias MGA-31589, a +5 V supply (Vdd) is connected to the output pin thru a RF choke, L2 (which isolates the inband signal from the DC supply). The low frequency bypass capacitors C6 and C7 help to eliminate low frequency signals from power supply. Blocking capacitors are required for its input (C8) and output (C9), to isolate the supply voltage from succeeding circuits. The recommended output tuning is for achieving wideband best OIP3, while meeting typical specifications for other parameters.

MGA31589 Typical Scattering Parameter^[1]

T_A = 25° C, V_{dd} = 5.0 V, I_{dd} = 146 mA, Z_o = 50 Ω

Freq (GHz)	S11 (dB)	S11 (ang)	S21 (dB)	S21 (ang)	S12 (dB)	S12 (ang)	S22 (dB)	S22 (ang)	k
0.1	-1.77	-176.55	19.58	136.19	-34.90	8.42	-3.27	-170.20	0.972
0.2	-1.67	177.54	16.85	145.31	-35.04	7.22	-3.22	-177.59	1.244
0.3	-1.72	173.67	16.41	149.08	-34.65	10.46	-2.82	179.75	1.275
0.4	-1.77	170.76	16.37	147.43	-34.05	11.21	-2.29	174.84	1.212
0.5	-1.83	168.30	16.34	143.00	-33.53	9.91	-2.07	169.34	1.177
0.6	-1.87	165.91	16.23	138.05	-33.16	8.33	-2.02	164.14	1.166
0.7	-1.90	163.53	16.08	133.00	-32.88	6.93	-2.06	159.35	1.168
0.8	-1.94	161.13	15.93	127.98	-32.61	5.62	-2.14	154.89	1.176
0.9	-1.98	158.73	15.76	123.03	-32.38	4.31	-2.25	150.65	1.189
1.0	-2.05	155.91	15.71	117.78	-32.03	2.68	-2.42	146.01	1.201
1.5	-2.30	143.20	15.13	94.05	-30.80	-5.20	-3.26	126.15	1.269
2.0	-2.58	131.24	14.79	71.01	-29.78	-15.44	-4.42	106.91	1.339
2.5	-2.97	119.80	14.64	46.54	-29.03	-29.02	-6.37	85.09	1.432
3.0	-3.38	109.13	14.52	20.10	-28.80	-45.16	-9.78	59.67	1.563
3.5	-3.66	99.38	14.28	-8.36	-29.30	-62.45	-17.08	28.50	1.750
4.0	-3.67	89.65	13.76	-38.65	-30.76	-78.63	-23.37	-158.95	2.051
4.5	-3.35	78.37	12.79	-70.05	-33.36	-87.86	-11.25	161.18	2.557
5.0	-2.72	69.55	11.22	-99.35	-35.92	-78.23	-7.01	133.77	2.926
5.5	-2.25	54.25	9.39	-127.96	-35.02	-63.36	-4.96	106.20	2.228
6.0	-1.90	37.98	7.35	-154.25	-32.62	-63.92	-3.73	81.48	1.420
6.5	-1.66	22.07	5.23	-178.40	-30.75	-73.57	-2.92	59.47	0.964
7.0	-1.49	6.75	3.14	158.99	-29.45	-86.55	-2.40	39.44	0.726
7.5	-1.37	-8.46	1.07	137.02	-28.55	-101.24	-2.10	20.23	0.634
8.0	-1.31	-23.53	-1.12	115.64	-28.08	-116.73	-1.99	1.07	0.763
8.5	-1.24	-38.62	-3.42	94.86	-27.89	-132.58	-1.99	-18.26	1.040
9.0	-1.15	-52.86	-5.90	75.16	-28.05	-148.05	-2.00	-37.13	1.491
9.5	-1.04	-65.05	-8.51	57.37	-28.46	-162.13	-1.93	-54.51	2.003
10.0	-0.93	-74.79	-11.10	41.67	-28.88	-174.70	-1.75	-69.74	2.471
10.5	-0.88	-83.14	-13.57	27.46	-29.23	173.83	-1.51	-82.60	2.966
11.0	-0.87	-91.24	-15.94	14.15	-29.46	162.64	-1.26	-93.38	3.480
11.5	-0.87	-99.83	-18.27	1.08	-29.63	151.89	-1.08	-102.57	4.186
12.0	-0.89	-108.98	-20.69	-12.23	-29.72	140.81	-0.99	-110.85	5.464
12.5	-0.90	-118.43	-23.36	-26.45	-29.77	128.66	-1.07	-119.52	8.527
13.0	-0.90	-127.25	-26.67	-42.33	-30.04	114.68	-1.36	-130.22	16.497
13.5	-0.79	-134.85	-31.56	-55.65	-30.86	102.56	-1.82	-144.24	36.982
14.0	-0.66	-142.23	-37.35	-61.23	-31.33	93.78	-2.25	-161.00	76.824
14.5	-0.64	-149.26	-47.45	-58.90	-31.61	84.09	-2.33	-176.91	255.376
15.0	-0.66	-156.32	-48.66	73.73	-31.91	75.57	-2.04	171.92	284.336
15.5	-0.71	-163.50	-40.13	79.58	-31.96	69.43	-1.64	166.22	96.597
16.0	-0.79	-170.94	-35.71	75.52	-31.36	64.76	-1.27	164.25	47.911
16.5	-0.85	-178.86	-32.13	66.97	-29.97	58.14	-0.97	163.32	23.387
17.0	-0.94	171.97	-29.15	54.52	-28.27	47.58	-0.83	160.50	13.048
17.5	-1.05	162.04	-26.61	39.34	-26.63	33.70	-1.09	152.54	11.264
18.0	-1.18	151.96	-24.66	20.98	-25.34	16.84	-2.03	137.49	14.322
18.5	-1.35	142.56	-23.66	1.12	-24.79	-1.31	-3.78	116.75	20.654
19.0	-1.50	134.05	-23.71	-15.16	-25.17	-15.72	-5.58	99.74	29.409
19.5	-1.72	127.31	-23.25	-26.68	-24.89	-25.23	-4.69	87.70	27.596
20.0	-1.98	122.16	-24.07	-36.24	-25.77	-32.73	-6.17	75.97	43.126

MGA-31589 Typical Noise Parameters [1]

$T_A = 25^\circ \text{C}$, $V_{dd} = 5.0 \text{ V}$, $I_{dd} = 146 \text{ mA}$, $Z_0 = 50 \Omega$

Freq (GHz)	F_{min} (dB)	Γ_{opt} Mag	Γ_{opt} Ang	R_n/Z_0	Ga (dB)
0.5	1.80	0.59	-163.70	0.08	22.27
0.8	1.75	0.59	-157.40	0.07	21.69
0.9	1.54	0.59	-158.60	0.06	21.39
1.0	1.53	0.59	-151.30	0.07	21.11
1.5	1.34	0.58	-143.30	0.09	19.79
2.0	1.23	0.57	-131.00	0.13	18.67
2.5	1.15	0.56	-119.80	0.19	17.84
3.0	1.30	0.54	-109.00	0.23	17.13
3.5	1.48	0.53	-99.50	0.34	16.60
4.0	1.93	0.52	-91.50	0.54	16.16
4.5	2.64	0.51	-78.50	0.81	15.76
5.0	3.68	0.50	-58.60	1.29	15.03
5.5	5.06	0.49	-22.80	1.98	13.26
6.0	6.70	0.48	-5.40	2.68	11.93

Note:

1. Measurements are made using 10 mils Rogers RO4350 TRL Board.

Part Number Ordering Information

Part Number	No. of Devices	Container
MGA-31589-BLKG	100	Antistatic Bag
MGA-31589-TR1G	3000	13" Tape/Reel

SOT89 Package Dimensions

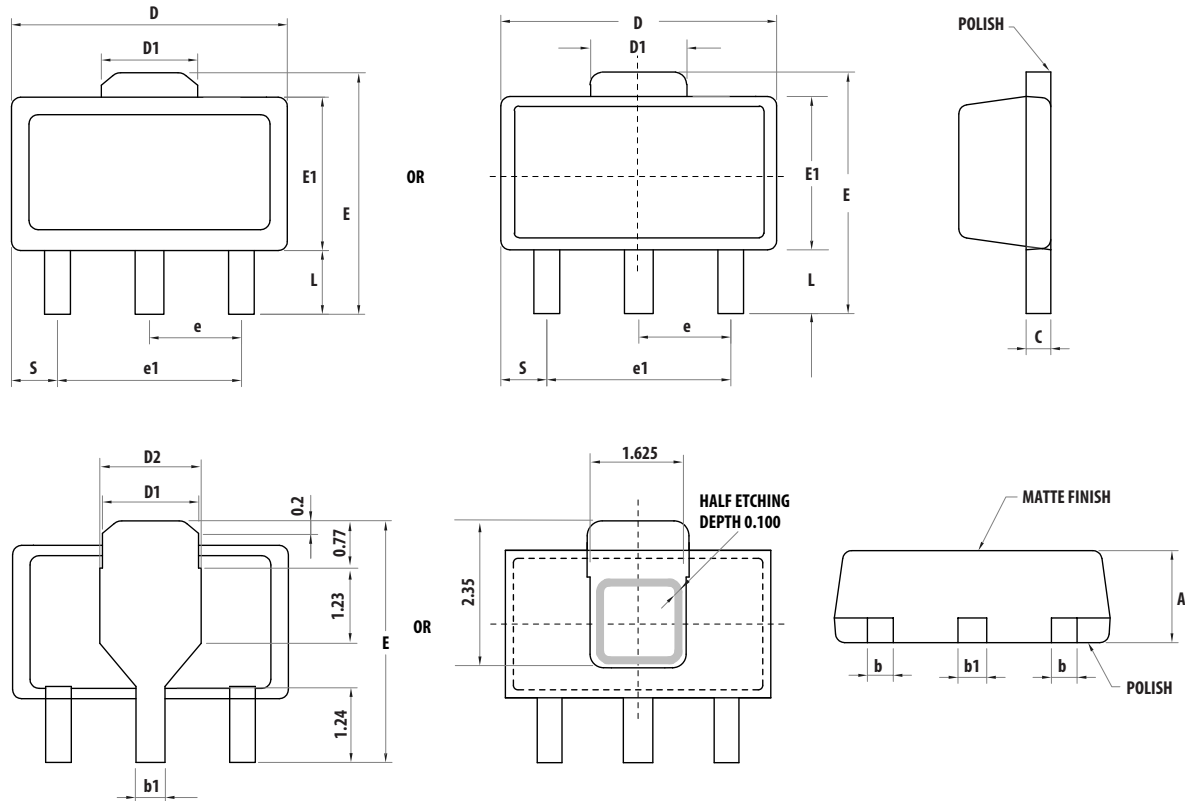

Symbols	Dimensions in mm			Dimensions in inches		
	Minimum	Nominal	Maximum	Minimum	Nominal	Maximum
A	1.40	1.50	1.60	0.055	0.059	0.063
L	0.89	1.04	1.20	0.0350	0.041	0.047
b	0.36	0.42	0.48	0.014	0.016	0.018
b1	0.41	0.47	0.53	0.016	0.018	0.030
C	0.38	0.40	0.43	0.014	0.015	0.017
D	4.40	4.50	4.60	0.173	0.177	0.181
D1	1.40	1.60	1.75	0.055	0.062	0.069
D2	1.45	1.65	1.80	0.055	0.062	0.069
E	3.94	-	4.25	0.155	-	0.167
E1	2.40	2.50	2.60	0.094	0.098	0.102
e1	2.90	3.00	3.10	0.114	0.118	0.122
S	0.65	0.75	0.85	0.026	0.030	0.034
e	1.40	1.50	1.60	0.054	0.059	0.063

Device Orientation

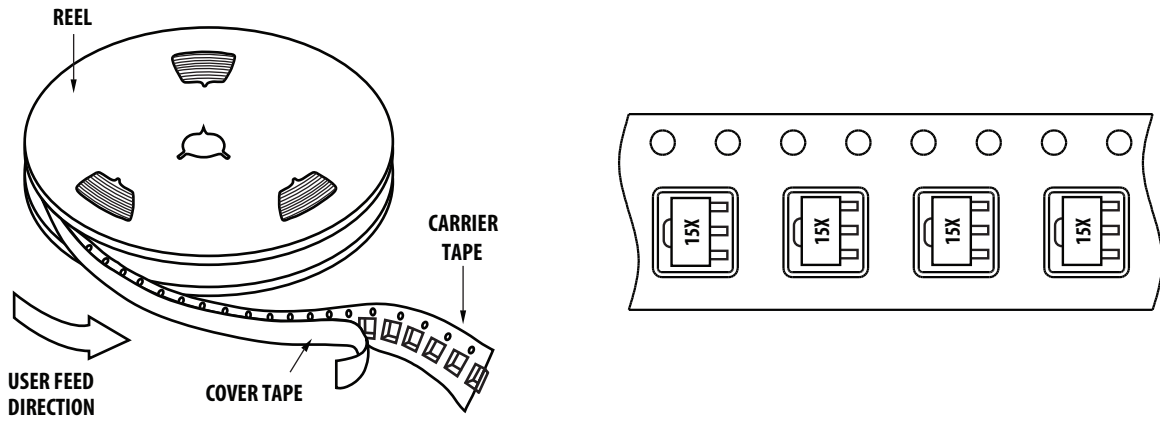

Tape Dimensions

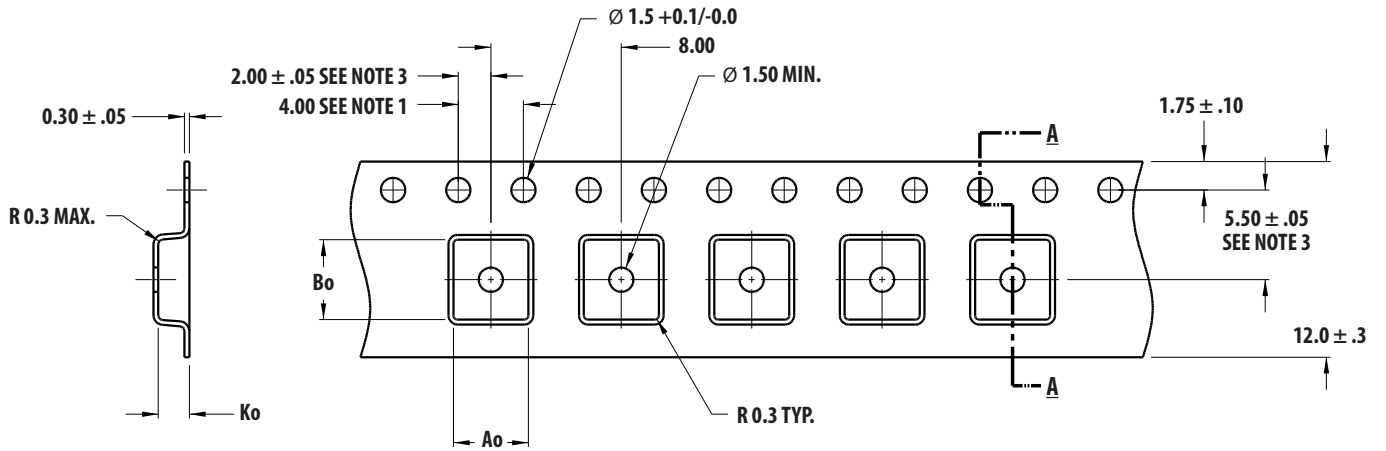

SECTION A - A

Ao = 4.60
Bo = 4.90
Ko = 1.90

DIMENSIONS IN MM

NOTES:

1. 10 SPROCKET HOLE PITCH CUMULATIVE TOLERANCE ± 0.2
2. CAMBER IN COMPLIANCE WITH EIA 481
3. POCKET POSITION RELATIVE TO SPROCKET HOLE MEASURED AS TRUE POSITION OF POCKET, NOT POCKET HOLE

Reel Dimensions – 13" Reel

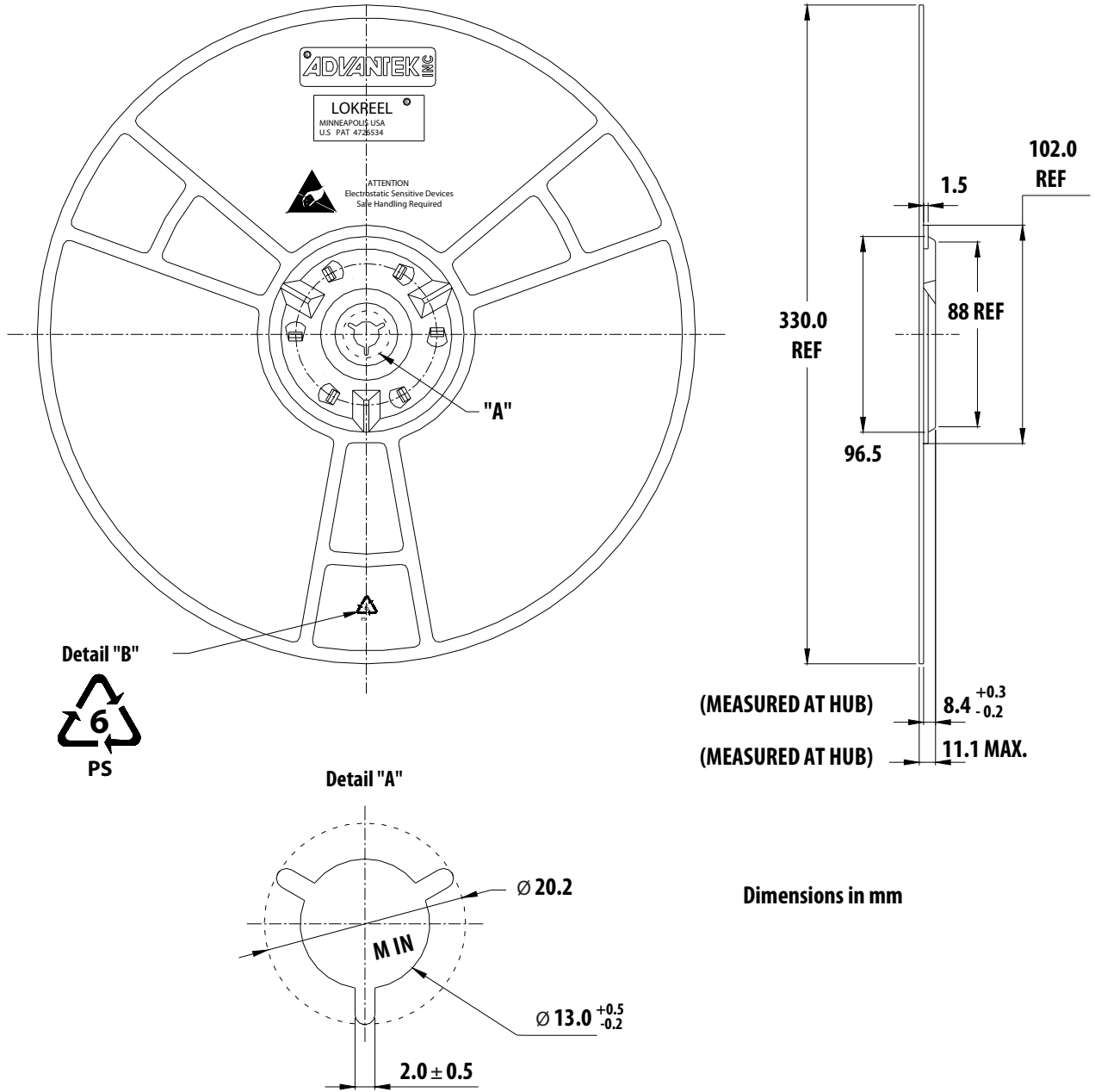

For product information and a complete list of distributors, please go to our web site: www.avagotech.com

Avago, Avago Technologies, and the A logo are trademarks of Avago Technologies in the United States and other countries. Data subject to change. Copyright © 2005-2013 Avago Technologies. All rights reserved. AV02-2744EN - May 23, 2013

