

DATA SHEET

SA3600

Low voltage dual-band RF front-end

Product specification
Supersedes data of 1999 March 18

1999 Nov 02

Low voltage dual-band RF front-end

SA3600

DESCRIPTION

The SA3600 is an integrated dual-band RF front-end that operates at both cellular (AMPS and TDMA) and PCS (TDMA) frequencies, and is designed in a 20 GHz f_T BiCMOS process—QUBiC2.

The low-band (LB) receiver is a combined low-noise amplifier (LNA) and mixer. The LNA has a 1.7 dB noise figure (NF) at 881 MHz with 17 dB of gain and an IIP3 of -7 dBm. The wide-dynamic range mixer has a 9.5 dB NF at 881 MHz with 9.5 dB of gain and an IIP3 of $+6$ dBm.

The high-band (HB) receiver is a combined low-noise amplifier (LNA) and mixer, with the low-band and high-band mixers sharing the same mixer output. The LNA has a 2.2 dB NF at 1960 MHz with 16 dB of gain and an IIP3 of -5 dBm. The wide-dynamic range mixer has a 8.5 dB NF at 1960 MHz with 8.5 dB of gain and an IIP3 of $+5.5$ dBm.

FEATURES

- Low current consumption: LB $I_{CC} = 14.5$ mA; HB $I_{CC} = 20.5$ mA
- Outstanding low- and high-band noise figure
- LNAs with gain control (30 dB gain step)
- LO input and output buffers
- Selectable frequency doubler
- On chip logic for network selection and power down
- Very small outline package

APPLICATIONS

- 800 to 1000 MHz analog and digital receivers
- 1800 to 2000 MHz digital receivers
- Portable radios
- Mobile communications equipment

PIN CONFIGURATION

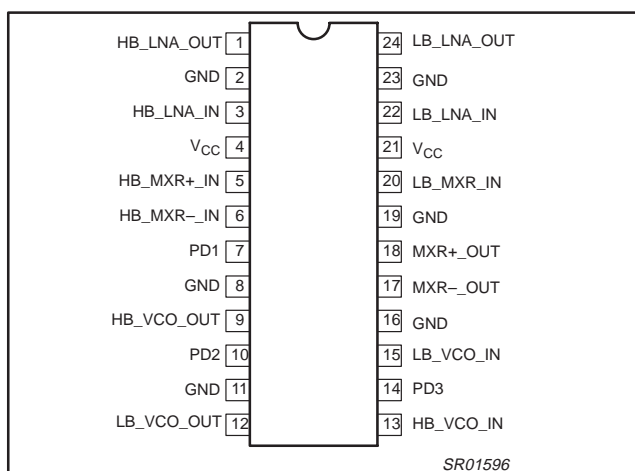

ORDERING INFORMATION

TYPE NUMBER	PACKAGE		
	NAME	DESCRIPTION	VERSION
SA3600	TSSOP24	Plastic thin shrink small outline package; 24 leads; body width 4.4 mm	SOT355-1

PIN DESCRIPTIONS

PIN NO.	PIN NAME	DESCRIPTION	PIN NO.	PIN NAME	DESCRIPTION
1	HB_LNA_OUT	Highband LNA output	13	HB_VCO_IN	Highband VCO input
2	GND	Ground	14	PD3	Power down control 3
3	HB_LNA_IN	Highband LNA input	15	LB_VCO_IN	Lowband VCO input
4	Vcc	Power supply	16	GND	Ground
5	HB_MXR+_IN	Highband mixer positive input	17	MXR-_OUT	Mixer negative output
6	HB_MXR-_IN	Highband mixer negative input	18	MXR+_OUT	Mixer positive output
7	PD1	Power down control 1	19	GND	Ground
8	GND	Ground	20	LB_MXR_IN	Lowband mixer input
9	HB_VCO_OUT	Highband VCO buffered output	21	V _{CC}	Power supply
10	PD2	Power down control 2	22	LB_LNA_IN	Lowband LNA input
11	GND	Ground	23	GND	Ground
12	LB_VCO_OUT	Lowband VCO buffered output	24	LB_LNA_OUT	Lowband LNA output

Low voltage dual-band RF front-end

SA3600

BLOCK DIAGRAM

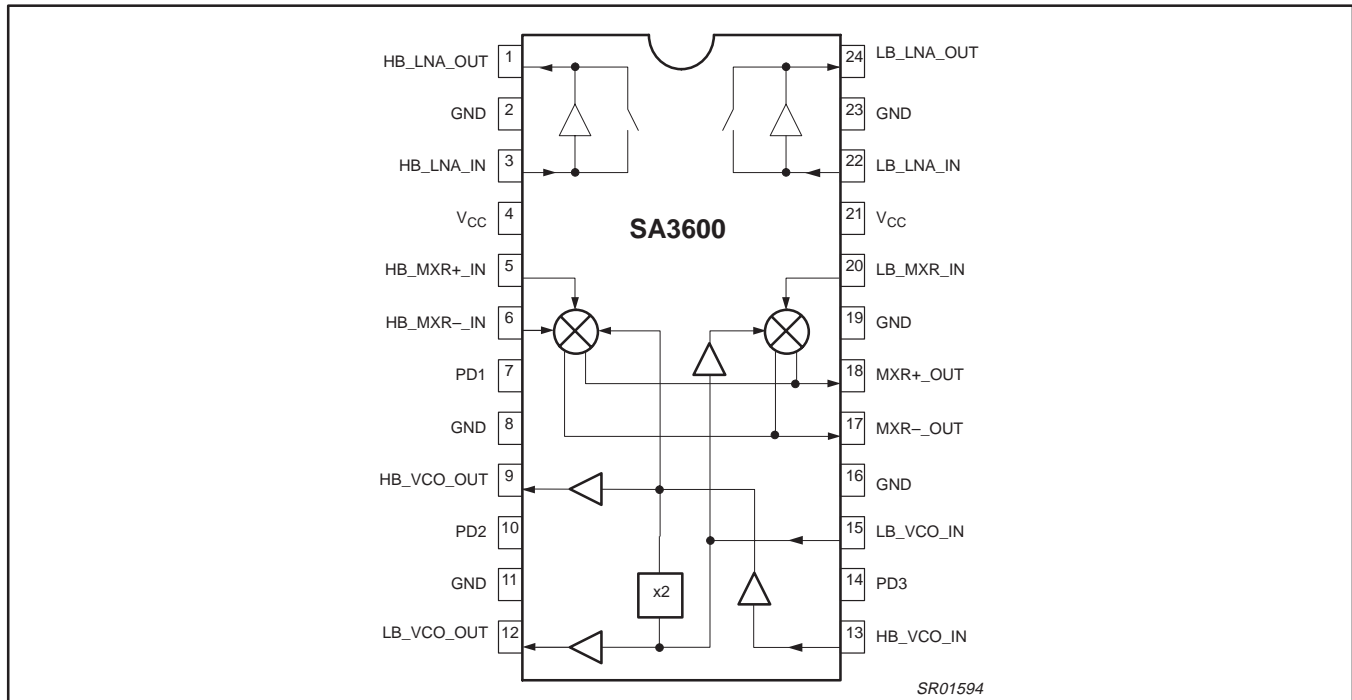

Figure 1. Block Diagram

MODE SELECT LOGIC

PD1	PD2	PD3	OPERATING MODE	Cel LNA	Cel MXR	PCS LNA	PCS MXR	x2 DBL	LB LO O/P	HB LO O/P
0	0	0	Sleep mode	off	off	off	off	off	off	off
0	0	1	Tx mode, LO lowband buffer	off	off	off	off	off	on	off
0	1	0	Rx mode cellular, low gain	off	on	off	off	off	on	off
0	1	1	Rx mode cellular, high gain	on	on	off	off	off	on	off
1	0	0	Rx mode PCS, low gain, x2	off	off	off	on	on	on	off
1	0	1	Rx mode PCS, high gain, x2	off	off	on	on	on	on	off
1	1	0	Rx mode PCS, low gain, no x2	off	off	off	on	off	off	on
1	1	1	Rx mode PCS, high gain, no x2	off	off	on	on	off	off	on

Low voltage dual-band RF front-end

SA3600

OPERATION

The SA3600 is a highly integrated dual-band radio frequency (RF) front-end integrated circuit (IC) targeted for TDMA applications. This IC is split into separate low-band (LB) and high-band (HB) receivers. The LB receiver contains a low noise amplifier (LNA) and mixer that are designed to operate in the cellular frequency range (869–894MHz). The HB receiver contains an LNA and mixer that are designed to operate in the PCS frequency range (1930–1990 MHz). The SA3600 also contains a frequency doubler that can drive the HB mixer local oscillator (LO) port, allowing a single-band voltage controlled oscillator (VCO) to be used to drive both mixers. Modes for bypassing the doubler are also provided, in the case where a dual-band VCO is used.

The SA3600 has eight modes of operation that control the LNAs, mixers, LO buffers and doubler. The select pins (PD1,2,3) are used to change modes of operation. The internal select logic powers the device down (0,0,0), turns on the LB LO buffer for use in transmit mode (0,0,1), enables cellular receive mode for high and low gain (0,1,X), enables PCS receive mode for high and low gain both without doubler (1,1,X) and with doubler (1,0,X).

Low-Band Receive Section

The LB circuit contains a LNA followed by a wide dynamic range active mixer. In a typical application circuit, the LNA output uses an external pull-up inductor to VCC and is AC coupled. The mixer IF outputs are differential and are combined with the high-band IF mixer outputs thereby eliminating the need for extra output pins. External inductors and capacitors can be used to convert the differential mixer outputs to single-ended. Furthermore, the LNA provides two gain settings: high gain (17dB) and low gain (–15 dB). The desired gain state can be selected by setting the logic pins (PD1,PD2,PD3) appropriately.

High-Band Receive Section

The HB circuit contains a LNA followed by a Gilbert cell mixer with differential inputs. The LNA output uses an internal pull-up inductor to VCC, which eliminates the need for an external pull-up. The mixer IF outputs are differential and are combined with the low-band IF mixer outputs thereby eliminating the need for extra output pins. Similar to the LB LNA, the HB LNA has two gain settings: high gain (16 dB) and low gain (–15 dB).

Control Logic Section

Pins PD1, PD2, and PD3, control the logic functions of the SA3600. The PD1 selects between LB and HB operations. In LB receive mode, the LB LNA is in high gain mode (or on) when PD1,2,3 are (0,1,1). In all other modes, the LB LNA is off. The LB mixer is on when PD1,2,3 are (0,1,X). In all other modes, the LB mixer is off. During transmit mode when PD1,2,3 are (0,0,1), the LB LO buffer is on, enabling use of the LO signal for the transmitter.

In HB receive mode, the HB LNA is in high gain mode (or on) when PD1,2,3 are (1,X,1). In all other modes, the HB LNA is off. The HB mixer is on when PD1,2,3 are (1,X,X), and is off in all other modes. The on-chip frequency doubler (X2) is on in (1,0,X) modes. When the frequency doubler is on, the input signal from the LB LO buffer is doubled in frequency, which can then be used to drive the HB mixer LO port. The frequency doubler can also be bypassed in modes (1,1,X), in which case the HB mixer is driven directly by an external 2 GHz LO signal.

Local Oscillator (LO) Section

The LB LO buffers are on for all modes except sleep mode, when PD1,2,3 are (0,0,0), and for HB receive mode without doubler, PD1,2,3 are (1,1,X). The HB LO buffers are on only when PD1,2,3 are (1,1,X). The PD1,2,3 pins are used to power-up/down all LO input buffers, which minimizes the pulling effect on the external VCO when entering receive or transmit mode.

Low voltage dual-band RF front-end

SA3600

ABSOLUTE MAXIMUM RATINGS¹

SYMBOL	PARAMETER	LIMITS		UNITS
		MIN.	MAX.	
V _{CC}	Supply voltage	-0.3	+4.5	V
V _{IN}	Voltage applied to any other pin	-0.3	V _{CC} +0.3	V
P _D	Power dissipation, T _{amb} = +25 °C (still air)		555	mW
T _{J MAX}	Maximum junction temperature		150	°C
P _{MAX}	Power input/output		+20	dBm
I _{MAX}	DC current into any I/O pin	-10	+10	mA
T _{STG}	Storage temperature range	-65	+150	°C
T _O	Operating temperature	-40	+85	°C

NOTES:

1. IC is protected against ESD voltages up to 500 V (human body model).

DC ELECTRICAL CHARACTERISTICS

Unless otherwise specified, all Input/Output ports are single-ended.

DC PARAMETERS

V_{CC} = +3.0 V, T_{amb} = +25°C unless otherwise specified

SYMBOL	PARAMETER	TEST CONDITIONS			TESTER LIMITS			UNIT
		PD1	PD2	PD3	MIN	TYP	MAX	
I _{CC}	Sleep mode	0	0	0		0.1	1	μA
	Tx mode, LO lowband buffer	0	0	1		4.3	5.5	mA
	Rx mode cellular, low gain	0	1	0		10.1	12	mA
	Rx mode cellular, high gain	0	1	1		14	16.5	mA
	Rx mode PCS, low gain, x2	1	0	0		17.5	21	mA
	Rx mode PCS, high gain, x2	1	0	1		23.5	28	mA
	Rx mode PCS, low gain, no x2	1	1	0		14.5	17.5	mA
	Rx mode PCS, high gain, no x2	1	1	1		20.5	24.5	mA
V _{IH}	Input HIGH voltage				0.5xV _{CC}		V _{CC} +0.3	V
V _{IL}	Input LOW voltage				-0.3		0.2xV _{CC}	V
I _{BIAS}	Input bias current	Logic 1 or logic 0			-5		+5	μA

Low voltage dual-band RF front-end

SA3600

AC ELECTRICAL CHARACTERISTICS $V_{CC} = +3.0\text{ V}$, $f_{RF} = 881\text{ MHz}$, $f_{LO} = 963\text{ MHz}$, $T_{amb} = +25^\circ\text{C}$, unless otherwise specified

SYMBOL	PARAMETER	TEST CONDITIONS	LIMITS					UNIT
			MIN.	-3σ	TYP	$+3\sigma$	MAX.	
Cascaded Gain Section								
G_{SYS}	LB LNA + Mixer, High Gain	Filter loss = 3 dB	20.5		23.5		26.5	dB
G_{BYP}	LB LNA + Mixer, Low Gain	Filter loss = 3 dB	-11.5		-8.5		-5.5	dB
Low-band LNA Section								
f_{RF}	RF input frequency range		869				894	MHz
G_{ENA}	Small signal gain ENABLED			16.1	17	17.9		dB
NF_{ENA}	Noise figure ENABLED			1.5	1.7	1.9		dB
$IIP3_{ENA}$	Input 3rd order Intercept Point			-8.1	-7	-5.9		dBm
$P1dB_{ENA}$	Input 1 dB Compression Point				-20			dBm
G_{BYP}	Small signal gain BYPASSED				-15			dB
NF_{BYP}	Noise figure BYPASSED				15			dB
$IIP3_{BYP}$	Input 3rd order Intercept Point				15			dBm
Z_{IN}	Input return loss ²	50 Ω system			10			dB
Z_{OUT}	Output return loss ²	50 Ω system			10			dB
T_{SW}	ENABLE/DISABLE speed ¹						20	μs
Low-band Mixer Section								
f_{RF}	RF input frequency range		869				894	MHz
f_{IF}	IF output frequency range		70				200	MHz
f_{LO}	LO input range		939				1100	MHz
G_{MXR}	Small signal gain	$P_{LO} = -5\text{ dBm}$		9	9.5	10		dB
NF_{MXR}	SSB Noise figure	$P_{LO} = -5\text{ dBm}$		8.6	9.5	10.4		dB
$IIP3_{MXR}$	Input 3rd order Intercept Point	$P_{LO} = -5\text{ dBm}$		5.1	6	6.9		dBm
$P1dB_{MXR}$	Input 1 dB Compression Point	$P_{LO} = -5\text{ dBm}$			-14			dBm
P_{LO}	LO input power range		-7		-5		-3	dBm
Z_{IN}	Input return loss ²	50 Ω system			10			dB
Z_{OUT}	Output return loss ²	50 Ω system			10			dB
2-Tone	Two-tone spurious rejection:	$P_{LO} = -5\text{ dBm}$						
	$2(f_{RF}-f_{TX}), f_{RF}-f_{TX}=f_{IF}/2$	$f_{RF}=890.0\text{ MHz @ -36 dBm}$ $f_{TX}=848.9\text{ MHz @ -20 dBm}$			-110			dBm
	$3(f_{RF}-f_{TX}), f_{RF}-f_{TX}=f_{IF}/3$	$f_{RF}=876.3\text{ MHz @ -36 dBm}$ $f_{TX}=848.9\text{ MHz @ -20 dBm}$			-110			dBm
RF-LO	RF to LO isolation				25			dB
LO-RF	LO to RF isolation				40			dB
T_{SW}	ENABLE/DISABLE speed ¹						20	μs
Low-band LO Buffer Section								
P_{LO}	LO Input frequency range		939				1100	MHz
P_{IN}	LO Input power	50 Ω matched LB_VCO_IN	-7		-5		-3	dBm
P_{OUT}	LO Output power	50 Ω matched LB_VCO_OUT		-8	-7.5	-7		dBm
Z_{IN}	Input return loss ²	50 Ω system			10			dB
Z_{OUT}	Output return loss ²	50 Ω system			10			dB
	Harmonic content	$P_{LO} = -5\text{ dBm}$			-20			dBc
T_{SW}	ENABLE/DISABLE speed ¹						20	μs

Low voltage dual-band RF front-end

SA3600

AC ELECTRICAL CHARACTERISTICS $V_{CC} = +3.0\text{ V}$, $f_{RF} = 1960\text{ MHz}$, $f_{LO} = 2042\text{ MHz}$, $T_{amb} = +25^\circ\text{C}$, unless otherwise specified

SYMBOL	PARAMETER	TEST CONDITIONS	LIMITS					UNIT
			MIN.	-3 σ	TYP	+3 σ	MAX.	
Cascaded Gain Section								
G_{SYS}	HB LNA + Mixer, High Gain	Filter loss = 3 dB	18.5		21.5		24.5	dB
G_{BYP}	HB LNA + Mixer, Low Gain	Filter loss = 3 dB	-12.5		-9.5		-6.5	dB
High-band LNA Section								
f_{RF}	RF input frequency range		1930				1990	MHz
G_{ENA}	Small signal gain ENABLED			15	16	17		dB
NF_{ENA}	Noise figure ENABLED			1.9	2.2	2.5		dB
$IIP3_{ENA}$	Input 3rd order Intercept Point			-6.5	-5	-3.5		dBm
$P1dB_{ENA}$	Input 1 dB Compression Point				-14			dBm
G_{BYP}	Small signal gain BYPASSED				-15			dB
NF_{BYP}	Noise figure BYPASSED				15			dB
$IIP3_{BYP}$	Input 3rd order Intercept Point				15			dBm
Z_{IN}	Input return loss ²	50 Ω system, ENA and BYP			10			dB
Z_{OUT}	Output return loss	50 Ω system, ENA and BYP			10			dB
T_{SW}	ENABLE/DISABLE speed ¹						20	μs
High-band Mixer Section								
f_{RF}	RF input frequency range		1930				1990	MHz
f_{IF}	IF output frequency range		70				200	MHz
f_{LO}	LO input range		2000				2190	MHz
G_{MXR}	Small signal gain	$P_{LO} = -5\text{ dBm}$		7.8	8.5	9.2		dB
NF_{MXR}	SSB Noise figure, doubler off	$P_{LO} = -5\text{ dBm}$		7.6	8.5	9.4		dB
	SSB Noise figure, doubler on	$P_{LO} = -5\text{ dBm}$		8.1	9	9.9		dB
$IIP3_{MXR}$	Input 3rd order Intercept Point, doubler off	$P_{LO} = -5\text{ dBm}$		4	5.5	7		dBm
	Input 3rd order Intercept Point, doubler on	$P_{LO} = -5\text{ dBm}$		1.9	3	4.1		dBm
$P1dB_{MXR}$	Input 1 dB Compression Point	$P_{LO} = -5\text{ dBm}$			-14			dBm
IF/2 rej.	Half-IF spurious rejection $2(f_{RF}-f_{LO})$, $f_{RF}-f_{LO}=f_{IF}/2$, doubler off	$f_{RF}=1972.0\text{ MHz @ -36 dBm}$ $f_{LO}=2013.1\text{ MHz @ -5 dBm}$			-90			dBm
	Half-IF spurious rejection $2(f_{RF}-f_{LO})$, $f_{RF}-f_{LO}=f_{IF}/2$, doubler on				-85			dBm
IF/3 rej.	Third-IF spurious rejection $3(f_{RF}-f_{LO})$, $f_{RF}-f_{LO}=f_{IF}/3$	$f_{RF}=1985.7\text{ MHz @ -36 dBm}$ $f_{LO}=2013.1\text{ MHz @ -5 dBm}$			-114			dBm
2-tone	Two-tone spurious rejection: $f_{RF}-f_{TX}$, $f_{RF}-f_{TX}=f_{IF}$	$P_{LO} = -5\text{ dBm}$, $f_{RF}=1933.0\text{ MHz @ -36 dBm}$ $f_{TX}=1850.8\text{ MHz @ -20 dBm}$			-70			dBm
	$2(f_{RF}-f_{TX})$, $f_{RF}-f_{TX}=f_{IF}/2$	$f_{RF}=1951.0\text{ MHz @ -36 dBm}$ $f_{TX}=1909.9\text{ MHz @ -20 dBm}$			-115			dBm
	$3(f_{RF}-f_{TX})$, $f_{RF}-f_{TX}=f_{IF}/3$	$f_{RF}=1937.3\text{ MHz @ -36 dBm}$ $f_{TX}=1909.9\text{ MHz @ -20 dBm}$			-125			dBm
P_{LO}	LO input power range		-7		-5		-3	dBm
Z_{IN}	Input return loss ²	50 Ω system			10			dB
Z_{OUT}	Output return loss ²	50 Ω system			10			dB
RF-LO	RF to LO isolation				40			dB
LO-RF	LO to RF isolation				30			dB
T_{SW}	ENABLE/DISABLE speed ¹						20	μs

Low voltage dual-band RF front-end

SA3600

AC ELECTRICAL CHARACTERISTICS $V_{CC} = +3.0\text{ V}$, $T_{amb} = +25^{\circ}\text{C}$, unless otherwise specified

SYMBOL	PARAMETER	TEST CONDITIONS	LIMITS					UNITS
			MIN.	-3 σ	TYP	+3 σ	MAX.	
High-band LO Buffer Section								
P_{LO}	LO Input frequency range		2000				2190	MHz
P_{IN}	LO Input power	50 Ω matched HB_VCO_IN	-7		-5		-3	dBm
P_{OUT}	LO Output power	50 Ω matched HB_VCO_OUT		-8.8	-8	-7.2		dBm
Z_{IN}	Input return loss ²	50 Ω system			10			dB
Z_{OUT}	Output return loss ²	50 Ω system			10			dB
	Harmonic content	$P_{LO} = -5\text{ dBm}$			-20			dBc
T_{SW}	ENABLE/DISABLE speed ¹						20	μs
x2 LO Doubler Section								
f_{LO}	LO Input frequency		1000				1095	MHz
P_{IN}	LO Input power	50 Ω matched LB_VCO_IN	-7		-5		-3	dBm
Z_{IN}	Input return loss ²	50 Ω system			10			dB
Z_{OUT}	Output return loss ²	50 Ω system			10			dB
T_{SW}	ENABLE/DISABLE speed ¹						20	μs

NOTES:

1. Dependent on external components.
2. External matching required.

Low voltage dual-band RF front-end

SA3600

PIN NO	PIN MNEMONIC	DC V	EQUIVALENT CIRCUIT
1	HB LNA OUT		<p>SR01786</p>
3	HB LNA IN	0.8	<p>SR01787</p>
4	V _{CC}		<p>SR01788</p>
5	HB MXR+ IN	1.2	
6	HB MXR- IN	1.2	
7	PD1	Apply externally	<p>SR01789</p>
10	PD2		
14	PD3		
9	HB VCO OUT	Pull-up externally to V _{CC}	<p>SR01790</p>

Low voltage dual-band RF front-end

SA3600

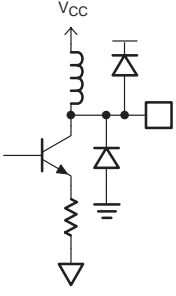
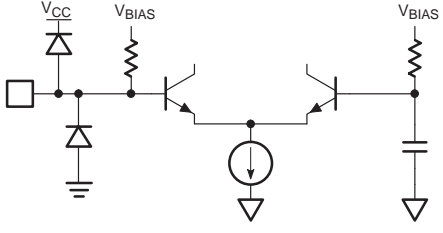
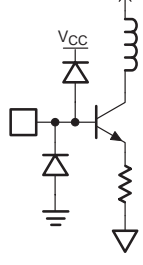
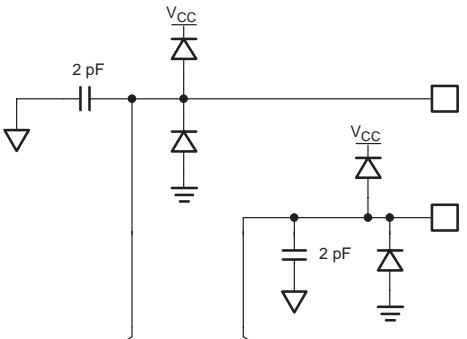
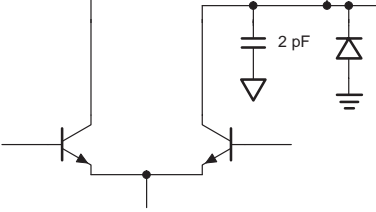
PIN NO	PIN MNEMONIC	DC V	EQUIVALENT CIRCUIT
12	LB VCO OUT	$V_{CC} - 0.2 V$	 <p style="text-align: center;">SR01791</p>
13	HB VCO IN	1.9	 <p style="text-align: center;">SR01792</p>
15	LB VCO IN	1.0	 <p style="text-align: center;">SR01793</p>
17	MXR- OUT	Pull-up externally to V_{CC}	
18	MXR+ OUT		 <p style="text-align: center;">SR01794</p>

Low voltage dual-band RF front-end

SA3600

PIN NO	PIN MNEMONIC	DC V	EQUIVALENT CIRCUIT
20	LB MXR IN	1.2	
22	LB LNA IN	0.8	
24	LB LNA OUT	Pull-up externally to VCC	

Low voltage dual-band RF front-end

SA3600

PERFORMANCE CHARACTERISTICS

$V_{CC} = +3.0\text{ V}$, $T_{amb} = +25^\circ\text{C}$; unless otherwise specified.

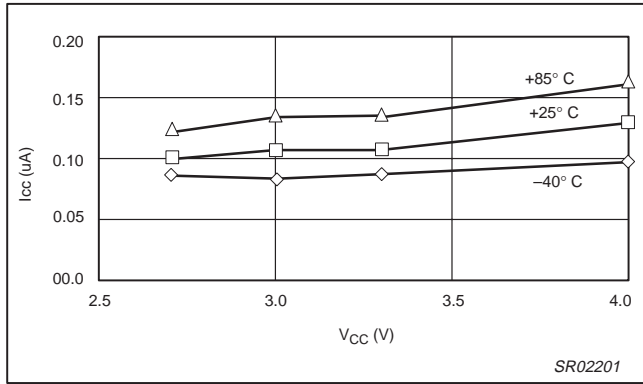

Figure 2. I_{CC} versus V_{CC} (mode 000 – sleep mode)

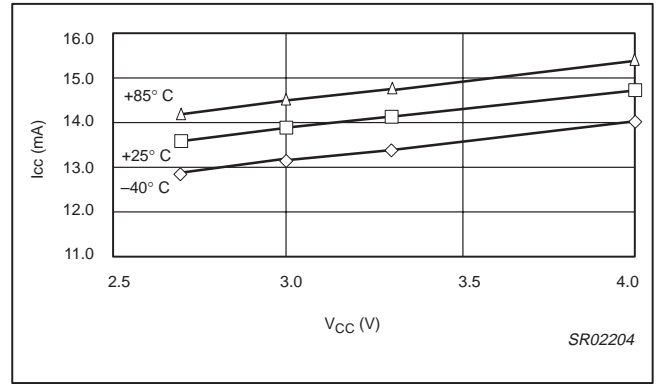

Figure 5. I_{CC} versus V_{CC} (mode 011 – LB receive, high gain)

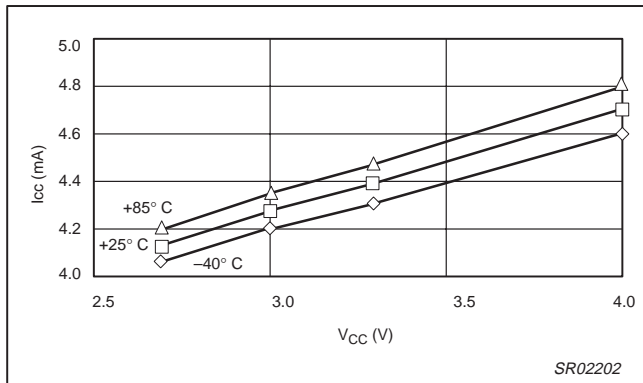

Figure 3. I_{CC} versus V_{CC} (mode 001 – transmit mode)

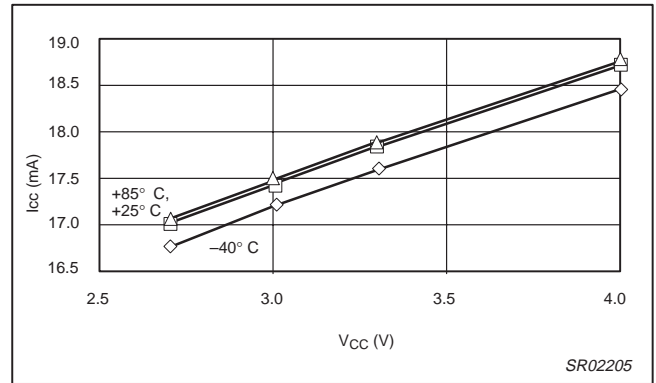

Figure 6. I_{CC} versus V_{CC} (mode 100 – HB receive, low gain, doubler on)

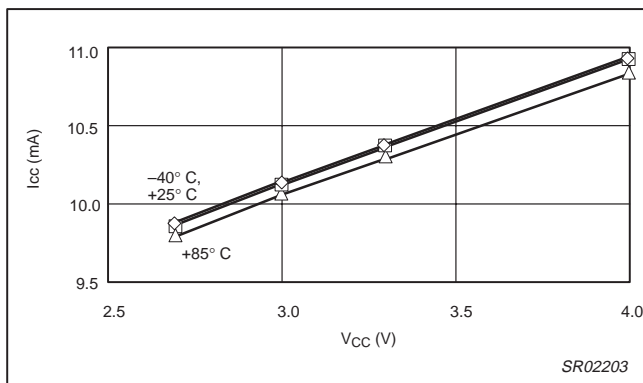

Figure 4. I_{CC} versus V_{CC} (mode 010 – LB receive, low gain)

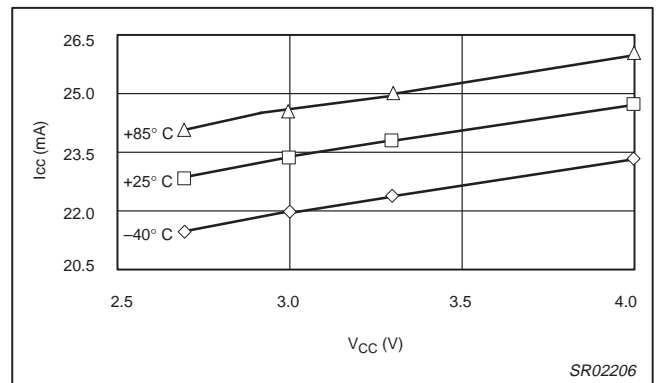

Figure 7. I_{CC} versus V_{CC} (mode 101 – HB receive, high gain, doubler on)

Low voltage dual-band RF front-end

SA3600

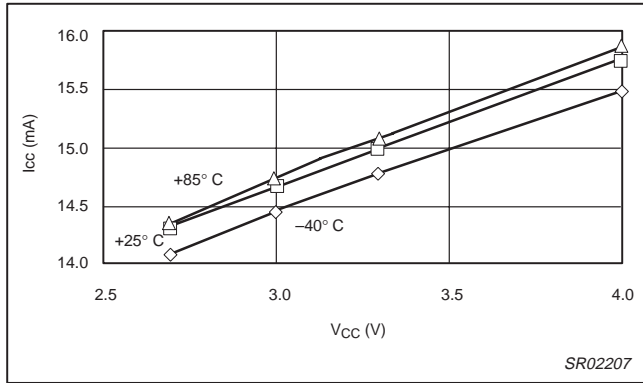

Figure 8. I_{CC} versus V_{CC} (mode 110 – HB receive, low gain, doubler off)

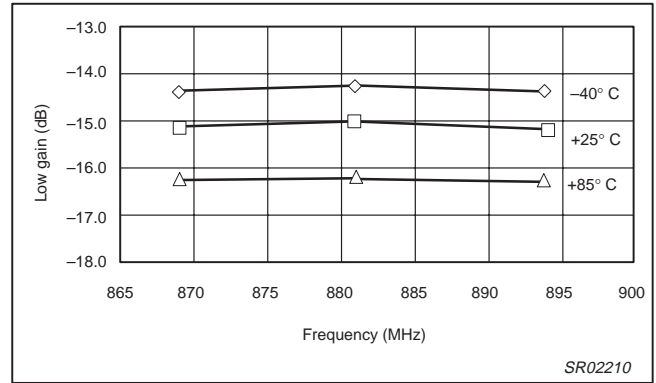

Figure 11. LB LNA low gain versus frequency

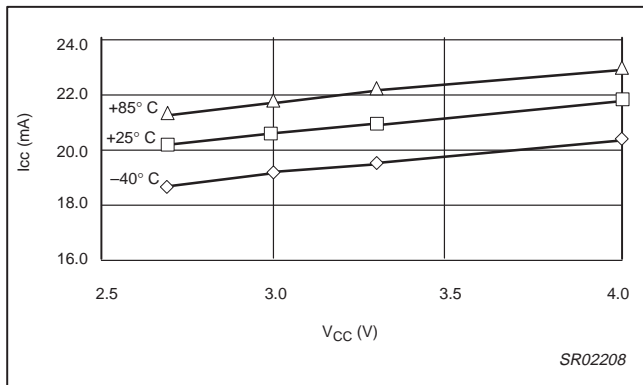

Figure 9. I_{CC} versus V_{CC} (mode 111 – HB receive, high gain, doubler off)

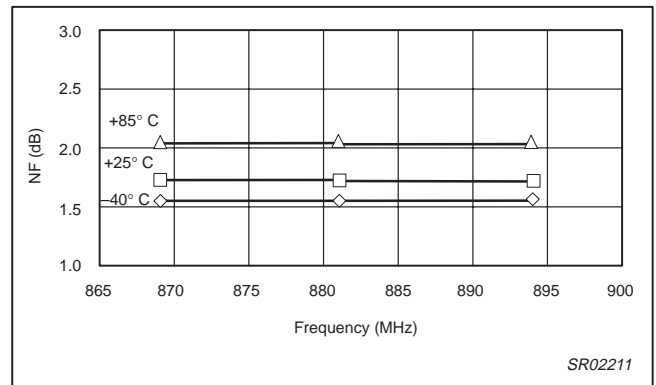

Figure 12. LB LNA noise figure versus frequency (high gain mode)

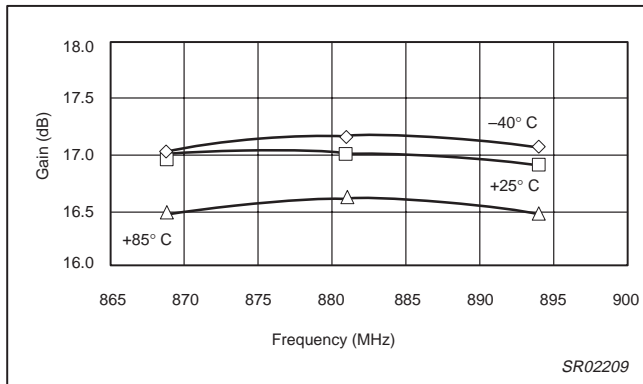

Figure 10. LB LNA gain versus frequency

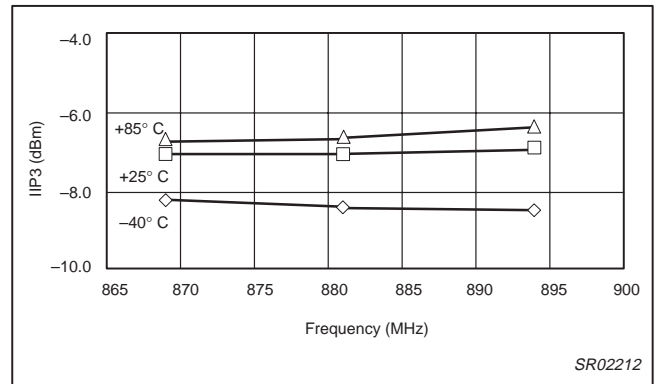

Figure 13. LB LNA IIP3 versus frequency (high gain mode)

Low voltage dual-band RF front-end

SA3600

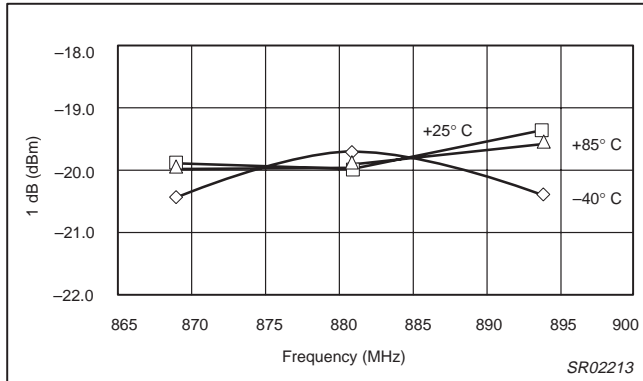

Figure 14. LB LNA 1 dB compression versus frequency (high gain mode)

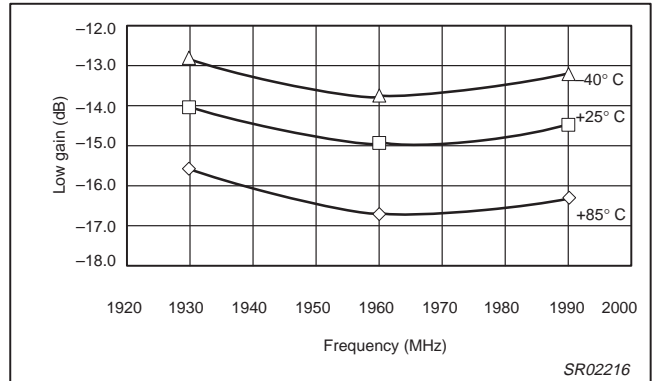

Figure 17. HB LNA low gain versus frequency

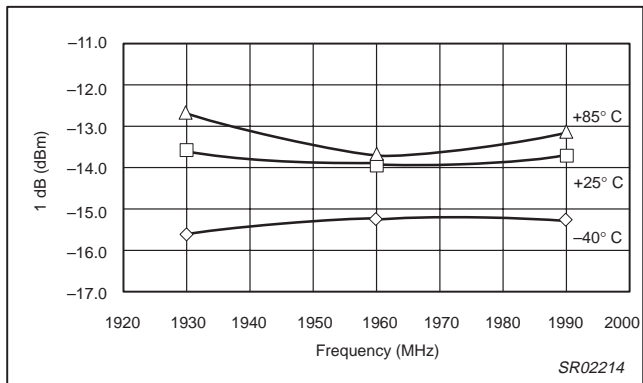

Figure 15. HB LNA 1 dB compression versus frequency (high gain mode)

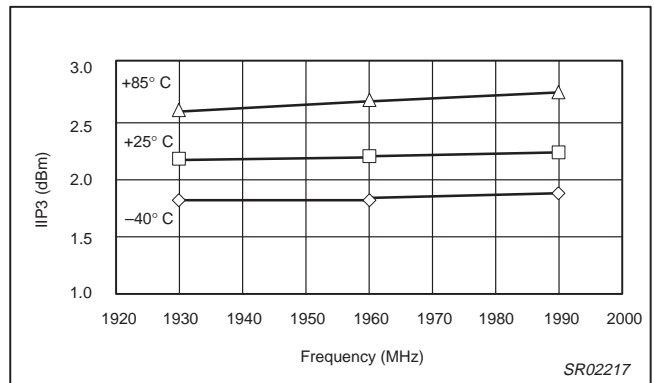

Figure 18. HB LNA noise figure versus frequency (high gain mode)

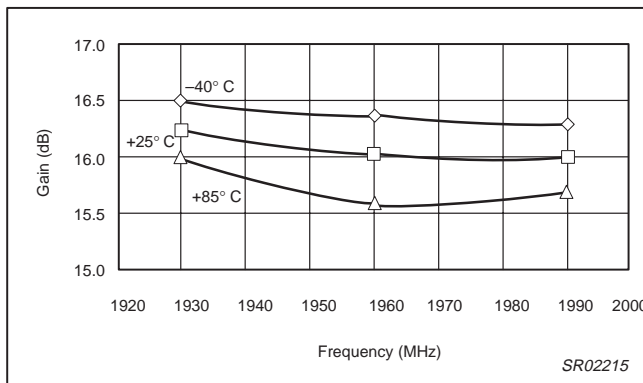

Figure 16. HB LNA gain versus frequency

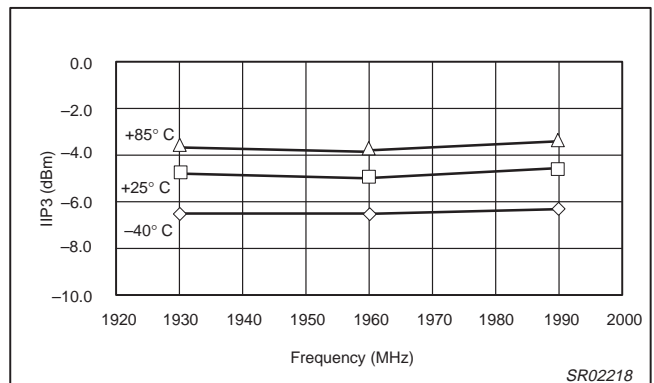

Figure 19. HB LNA IIP3 versus frequency (high gain mode)

Low voltage dual-band RF front-end

SA3600

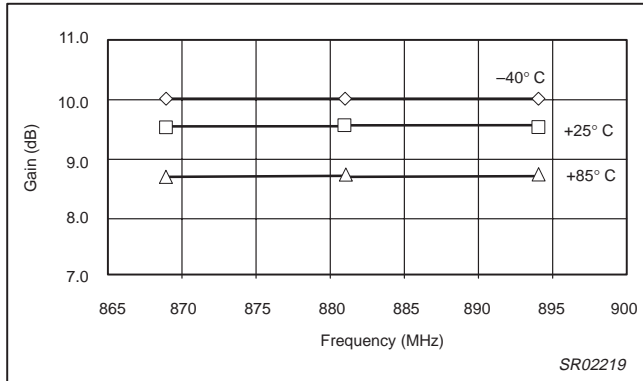

Figure 20. LB mixer conversion gain versus frequency

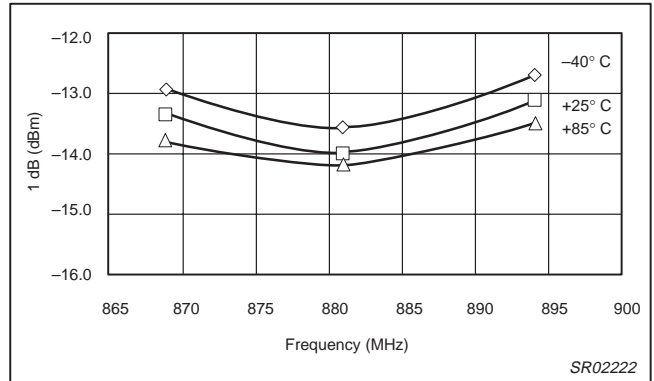

Figure 23. LB mixer 1 dB compression versus frequency

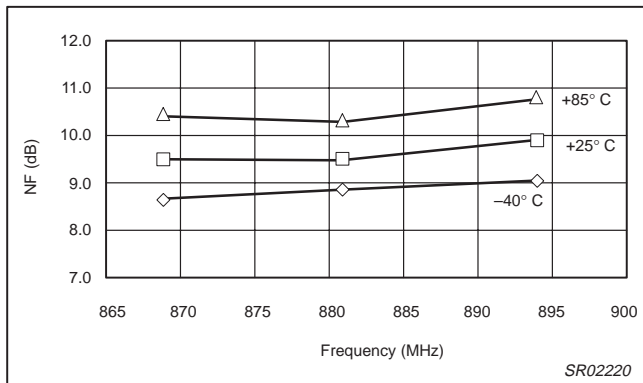

Figure 21. LB mixer noise figure versus frequency

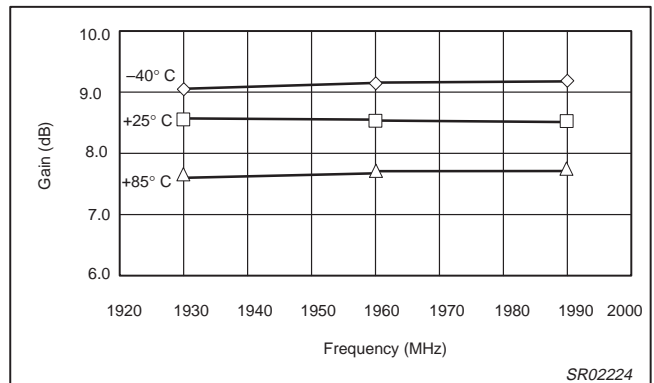

Figure 24. HB mixer conversion gain versus frequency, doubler off

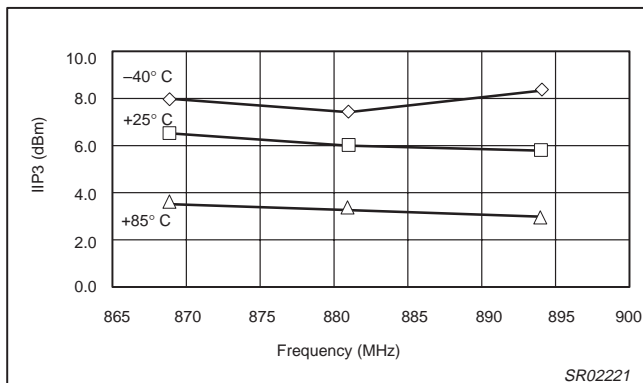

Figure 22. LB mixer input IP3 versus frequency

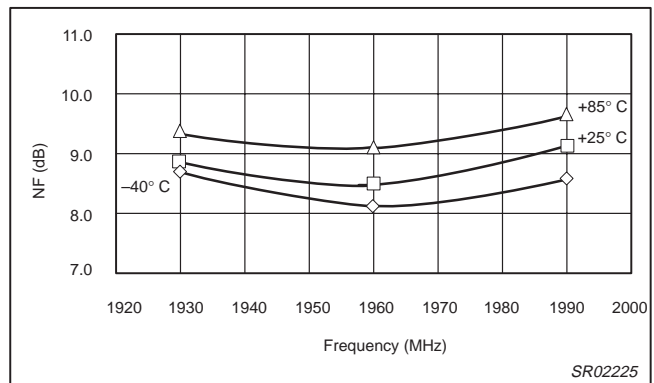

Figure 25. HB mixer noise figure versus frequency, doubler off

Low voltage dual-band RF front-end

SA3600

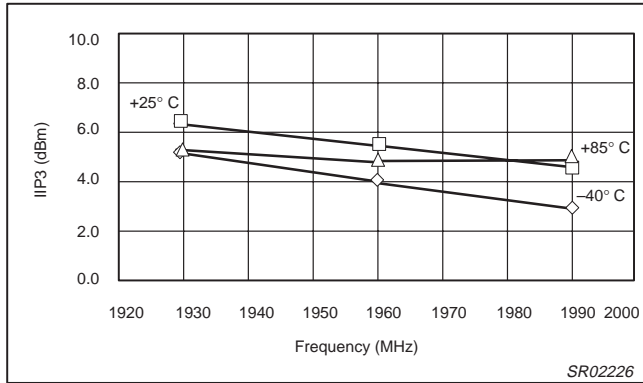

Figure 26. HB mixer input IP3 versus frequency, doubler off

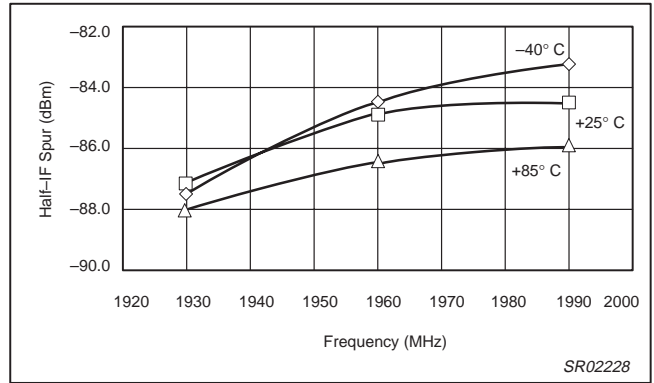

Figure 29. HB mixer half-IF spur versus frequency (input = -36 dBm, doubler on)

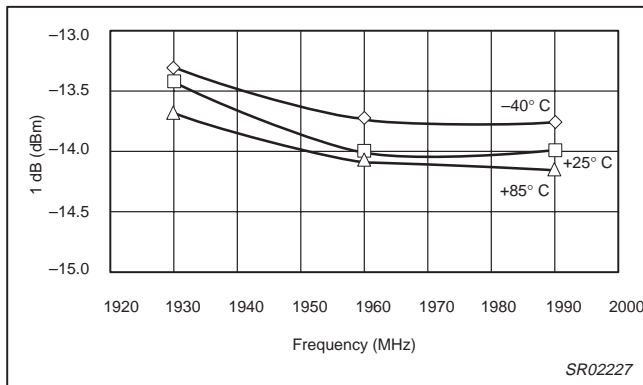

Figure 27. HB mixer 1 dB compression versus frequency, doubler off

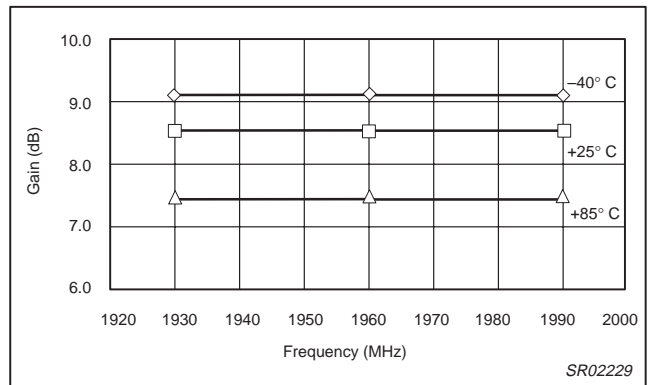

Figure 30. HB mixer conversion gain versus frequency, doubler on

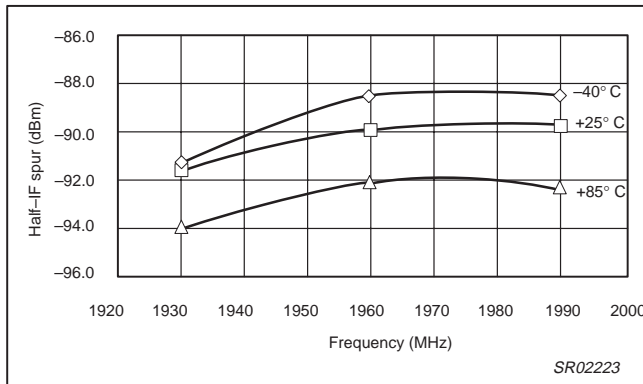

Figure 28. HB mixer half-IF spur versus frequency (input = -36 dBm, doubler off)

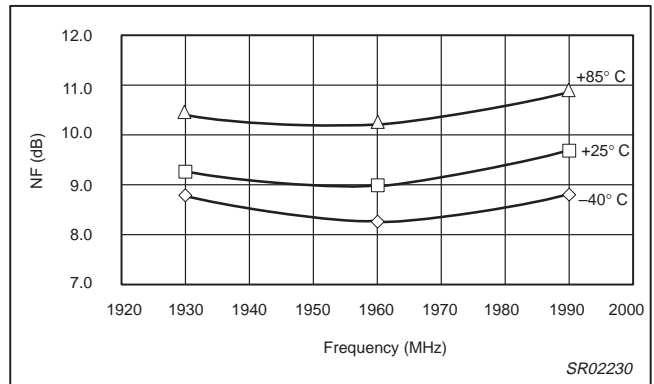

Figure 31. HB mixer noise figure versus frequency, doubler on

Low voltage dual-band RF front-end

SA3600

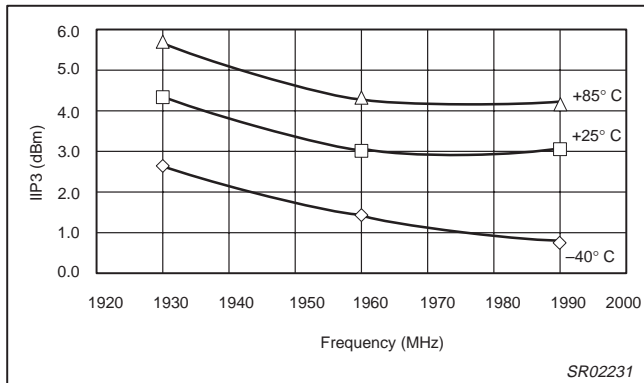

Figure 32. HB mixer input IP3 versus frequency, doubler on

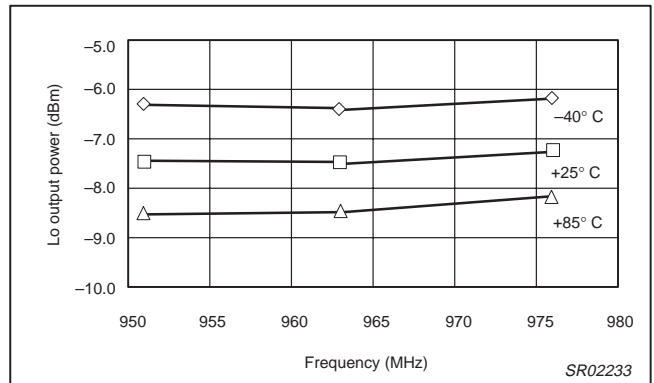

Figure 34. LB LO output power versus frequency (mode 010)

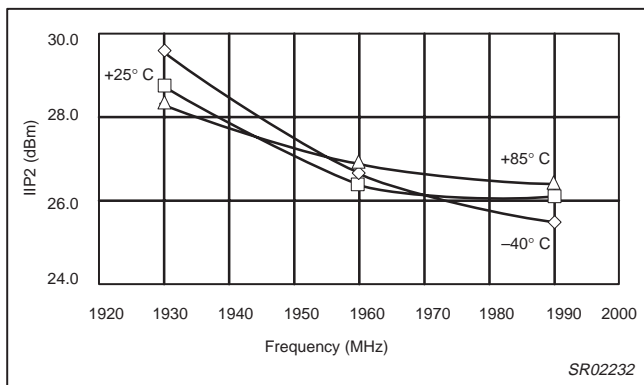

Figure 33. HB mixer input IP2 versus frequency, doubler on

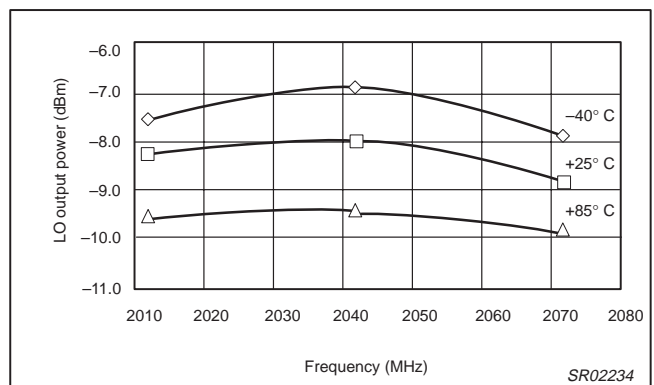
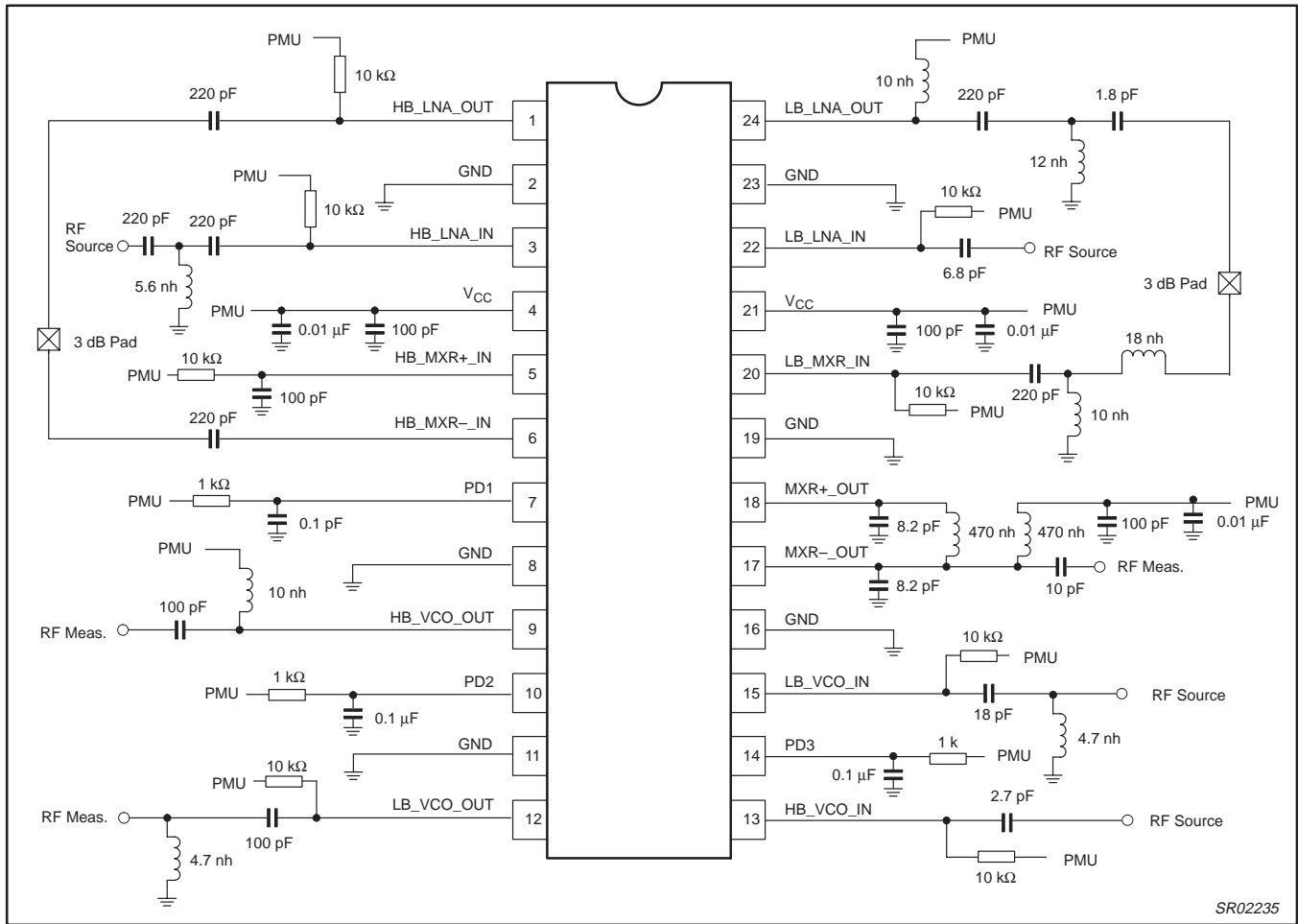

Figure 35. HB LO output power versus frequency (mode 110)

Low voltage dual-band RF front-end

SA3600



SR02235

Figure 36. SA3600 production test circuit schematic

Low voltage dual-band RF front-end

SA3600

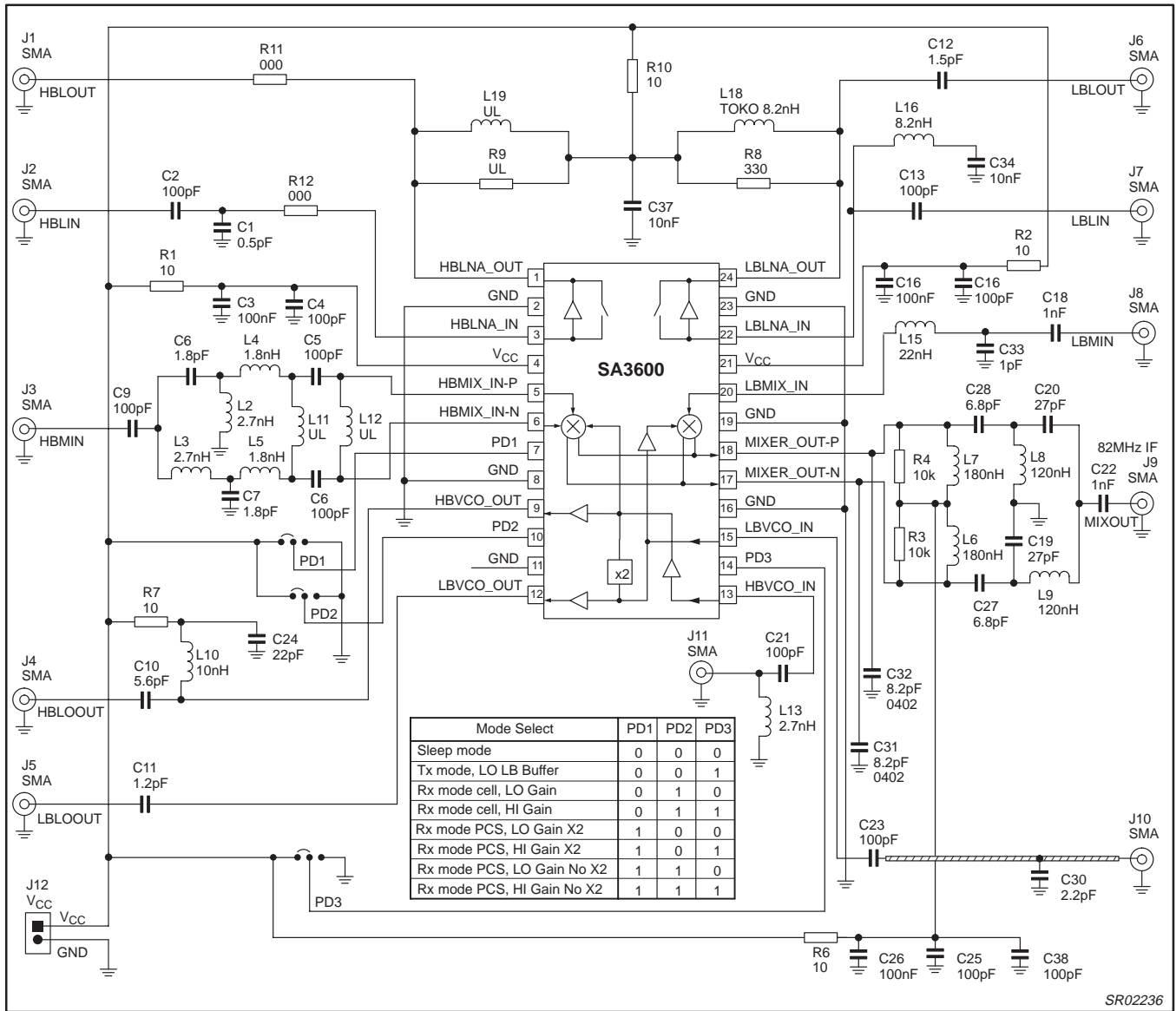

Figure 37. SA3600 Application circuit ($f_{IF} = 82$ MHz)

Low voltage dual-band RF front-end

SA3600

Table 1. Low-band LNA S-parameters (high gain mode)

Freq (MHz)	S11 (U)	<S11 (deg)	S21 (U)	<S21 (deg)	S12 (U)	<S12 (deg)	S22 (U)	<S22 (deg)
800	0.42	-89	5.19	89	0.006	14	0.98	-37
810	0.42	-89	5.17	89	0.006	19	0.98	-37
820	0.41	-90	5.11	88	0.005	45	0.98	-38
830	0.41	-91	5.11	87	0.004	11	0.98	-38
840	0.41	-91	5.03	86	0.008	14	0.98	-38
850	0.41	-92	4.97	85	0.007	-2	0.98	-39
860	0.40	-92	4.97	84	0.006	32	0.98	-40
870	0.40	-93	4.92	83	0.008	8	0.98	-40
880	0.40	-93	4.85	82	0.007	-9	0.98	-41
890	0.39	-93	4.84	81	0.006	-18	0.98	-42
900	0.39	-93	4.77	81	0.005	3	0.98	-42
910	0.39	-94	4.73	79	0.005	-12	0.97	-42
920	0.38	-94	4.67	79	0.009	3	0.98	-43
930	0.38	-94	4.61	78	0.007	13	0.98	-43
940	0.38	-95	4.55	77	0.003	-1	0.98	-44
950	0.37	-95	4.49	77	0.006	-33	0.98	-44
960	0.37	-95	4.43	76	0.005	-29	0.98	-44
970	0.37	-96	4.36	75	0.008	-46	0.98	-45
980	0.36	-96	4.30	75	0.006	8	0.97	-46
990	0.36	-96	4.25	74	0.009	-24	0.98	-47
1000	0.36	-97	4.23	74	0.005	21	0.98	-47
1010	0.36	-96	4.16	73	0.007	-8	0.98	-47
1020	0.36	-97	4.15	73	0.008	-20	0.98	-48
1030	0.36	-97	4.11	73	0.008	-22	0.97	-48
1040	0.35	-97	4.07	71	0.007	-55	0.97	-49
1050	0.35	-97	4.04	71	0.009	-35	0.98	-49

Low voltage dual-band RF front-end

SA3600

Table 2. Low-band LO input (pin 15) and output (pin 12) S-parameters

Freq(MHz)	S11 (U)	<S11 (deg)	S22 (U)	<S22 (deg)
670	0.37	-168	0.46	75
680	0.37	-168	0.47	73
690	0.35	-169	0.49	71
700	0.33	-171	0.50	69
710	0.32	-171	0.50	67
720	0.31	-171	0.51	66
730	0.30	-172	0.52	64
740	0.28	-171	0.53	63
750	0.27	-171	0.53	61
760	0.26	-170	0.54	60
770	0.25	-170	0.55	58
780	0.24	-168	0.56	56
790	0.23	-168	0.56	55
800	0.22	-165	0.58	54
810	0.21	-162	0.58	52
820	0.20	-160	0.59	51
830	0.20	-157	0.59	49
840	0.21	-153	0.60	48
850	0.21	-149	0.60	46
860	0.20	-147	0.61	45
870	0.21	-145	0.62	44
880	0.22	-141	0.62	42
890	0.23	-140	0.62	41
900	0.24	-137	0.63	40
910	0.25	-136	0.64	38
920	0.26	-136	0.64	37
930	0.27	-134	0.64	35
940	0.29	-134	0.65	35
950	0.30	-135	0.65	33
960	0.31	-134	0.65	32
970	0.32	-134	0.65	31
980	0.34	-135	0.66	30
990	0.35	-136	0.66	29
1000	0.37	-136	0.66	28
1010	0.38	-137	0.66	26
1020	0.39	-138	0.66	26
1030	0.41	-139	0.66	25
1040	0.42	-140	0.66	24
1050	0.43	-141	0.67	23
1060	0.44	-142	0.66	22

Low voltage dual-band RF front-end

SA3600

Table 2. Low-band LO input (pin 15) and output (pin 12) S-parameters (continued)

Freq(MHz)	S11 (U)	<S11 (deg)	S22 (U)	<S22 (deg)
1070	0.46	-143	0.66	21
1080	0.48	-144	0.66	21
1090	0.49	-145	0.66	20
1100	0.51	-147	0.66	20
1110	0.52	-150	0.67	19
1120	0.53	-151	0.67	18
1130	0.53	-153	0.67	18
1140	0.54	-155	0.67	18
1150	0.55	-156	0.68	17
1160	0.56	-157	0.68	16
1170	0.57	-159	0.68	16

Low voltage dual-band RF front-end

SA3600

Table 3. Mixer output S-parameters

Both pins (17, 18)		
Freq(MHz)	S11 (U)	<S11 (deg)
70	1.00	-8
80	1.00	-9
90	0.99	-10
100	0.99	-11
110	0.99	-12
120	0.99	-13
130	0.99	-14
140	0.99	-16
150	0.99	-16
160	0.99	-18
170	0.99	-19
180	0.99	-20
190	0.99	-21
200	0.99	-22

Low voltage dual-band RF front-end

SA3600

Table 4. Low-band mixer input S-parameters

Freq(MHz)	S11 (U)	<S11 (deg)
800	0.84	-14
810	0.85	-14
820	0.85	-14
830	0.85	-15
840	0.84	-15
850	0.85	-15
860	0.85	-15
870	0.84	-15
880	0.85	-15
890	0.85	-15
900	0.84	-16
910	0.85	-15
920	0.84	-16
930	0.85	-16
940	0.85	-17
950	0.85	-17
960	0.85	-17
970	0.84	-17
980	0.85	-17
990	0.84	-18
1000	0.84	-18
1010	0.85	-18
1020	0.84	-18
1030	0.85	-19
1040	0.84	-19
1050	0.85	-19

Low voltage dual-band RF front-end

SA3600

Table 5. High-band LNA S-parameters

Freq (MHz)	S11 (U)	<S11 (deg)	S21 (U)	<S21 (deg)	S12 (U)	<S12 (deg)	S22 (U)	<S22 (deg)
1800	0.38	156	6.73	172	0.05	105	0.13	-106
1810	0.37	156	6.77	170	0.05	113	0.11	-100
1820	0.37	155	6.82	168	0.05	109	0.10	-95
1830	0.37	154	6.79	167	0.05	107	0.10	-88
1840	0.36	155	6.84	165	0.05	106	0.09	-74
1850	0.36	154	6.80	164	0.05	102	0.09	-67
1860	0.35	155	6.81	162	0.05	108	0.10	-51
1870	0.35	154	6.85	161	0.05	101	0.10	-47
1880	0.34	152	6.84	159	0.05	102	0.12	-41
1890	0.33	154	6.84	158	0.05	107	0.13	-36
1900	0.33	153	6.83	157	0.05	102	0.14	-32
1910	0.33	154	6.83	155	0.05	101	0.15	-30
1920	0.32	153	6.87	154	0.05	102	0.17	-28
1930	0.32	154	6.84	152	0.05	99	0.18	-28
1940	0.32	153	6.86	151	0.05	101	0.19	-26
1950	0.32	153	6.84	149	0.05	103	0.21	-26
1960	0.32	154	6.78	148	0.05	101	0.22	-26
1970	0.32	155	6.80	146	0.05	100	0.24	-26
1980	0.31	154	6.75	145	0.04	100	0.26	-26
1990	0.32	156	6.72	143	0.04	99	0.27	-27
2000	0.31	155	6.68	142	0.05	100	0.28	-27
2010	0.31	156	6.68	141	0.05	103	0.30	-30
2020	0.31	157	6.65	139	0.04	104	0.31	-31
2030	0.31	158	6.63	138	0.04	96	0.32	-30
2040	0.31	158	6.59	137	0.05	105	0.33	-32
2050	0.31	159	6.58	135	0.05	104	0.34	-34

Low voltage dual-band RF front-end

SA3600

Table 6. High-band LO input (pin 13) and output (pin 9) S-parameters

Freq(MHz)	S11 (U)	<S11 (deg)	S22 (U)	<S22 (deg)
1700	0.82	-36	0.31	86
1710	0.82	-36	0.30	85
1720	0.82	-37	0.29	83
1730	0.82	-36	0.29	81
1740	0.82	-37	0.29	81
1750	0.83	-37	0.27	79
1760	0.82	-37	0.26	76
1770	0.82	-38	0.25	76
1780	0.82	-38	0.24	74
1790	0.83	-39	0.24	72
1800	0.82	-39	0.23	71
1810	0.82	-39	0.21	69
1820	0.83	-40	0.20	68
1830	0.82	-40	0.20	66
1840	0.82	-41	0.18	67
1850	0.82	-41	0.16	63
1860	0.82	-42	0.16	61
1870	0.82	-42	0.14	60
1880	0.82	-42	0.12	56
1890	0.82	-43	0.11	52
1900	0.82	-43	0.11	53
1910	0.81	-44	0.08	47
1920	0.82	-44	0.07	42
1930	0.81	-45	0.06	34
1940	0.81	-46	0.04	29
1950	0.81	-46	0.03	-1
1960	0.81	-47	0.02	-21
1970	0.80	-47	0.03	-57
1980	0.80	-48	0.04	-85
1990	0.80	-48	0.05	-103
2000	0.80	-48	0.07	-112
2010	0.80	-49	0.08	-112
2020	0.80	-50	0.10	-119
2030	0.80	-51	0.12	-120
2040	0.79	-51	0.13	-125
2050	0.79	-52	0.15	-127
2060	0.79	-52	0.16	-130
2070	0.79	-52	0.18	-133
2080	0.78	-53	0.20	-135
2090	0.77	-54	0.21	-136

Low voltage dual-band RF front-end

SA3600

Table 6. High-band LO input (pin 13) and output (pin 9) S-parameters (continued)

Freq(MHz)	S11 (U)	<S11 (deg)	S22 (U)	<S22 (deg)
2100	0.78	-54	0.23	-138
2110	0.77	-55	0.24	-139
2120	0.77	-56	0.26	-142
2130	0.77	-57	0.27	-144
2140	0.76	-57	0.29	-144
2150	0.77	-58	0.29	-145
2160	0.76	-58	0.31	-147
2170	0.76	-59	0.33	-148
2180	0.76	-60	0.34	-150
2190	0.76	-60	0.35	-150
2200	0.76	-61	0.36	-152

Low voltage dual-band RF front-end

SA3600

TSSOP24: plastic thin shrink small outline package; 24 leads; body width 4.4 mm

SOT355-1

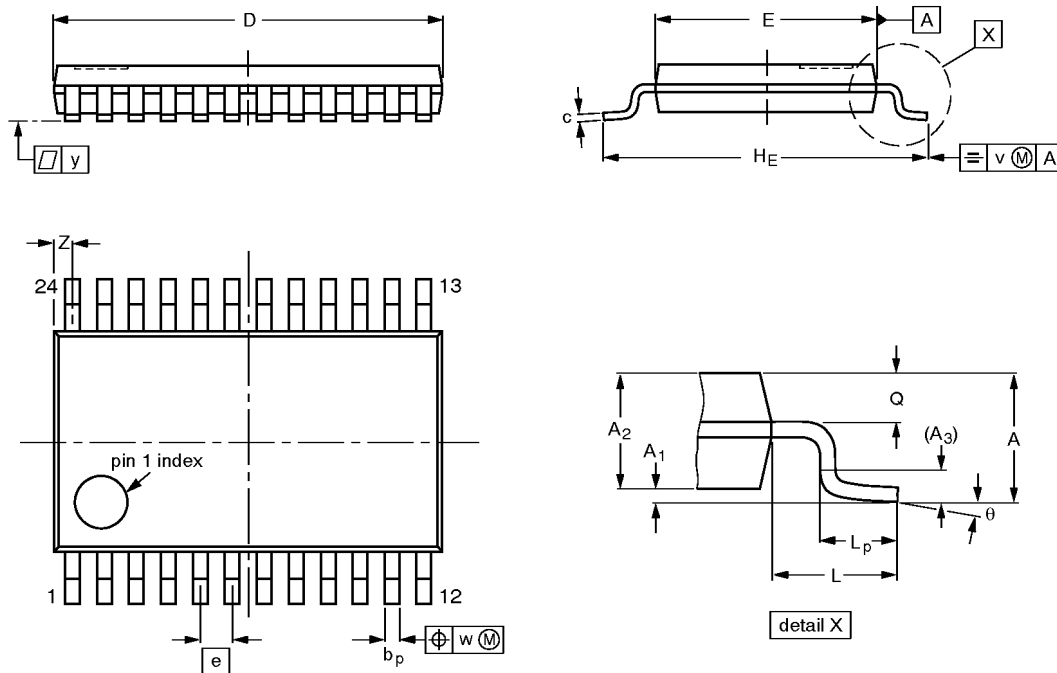

DIMENSIONS (mm are the original dimensions)

UNIT	A max.	A ₁	A ₂	A ₃	b _p	c	D ⁽¹⁾	E ⁽²⁾	e	H _E	L	L _p	Q	v	w	y	Z ⁽¹⁾	θ
mm	1.10	0.15 0.05	0.95 0.80	0.25	0.30 0.19	0.2 0.1	7.9 7.7	4.5 4.3	0.65	6.6 6.2	1.0	0.75 0.50	0.4 0.3	0.2	0.13	0.1	0.5 0.2	8° 0°

Notes

1. Plastic or metal protrusions of 0.15 mm maximum per side are not included.
2. Plastic interlead protrusions of 0.25 mm maximum per side are not included.

OUTLINE VERSION	REFERENCES				EUROPEAN PROJECTION	ISSUE DATE
	IEC	JEDEC	EIAJ			
SOT355-1		MO-153AD				93-06-16 95-02-04

Low voltage dual-band RF front-end

SA3600

NOTES

Low voltage dual-band RF front-end

SA3600

Data sheet status

Data sheet status	Product status	Definition [1]
Objective specification	Development	This data sheet contains the design target or goal specifications for product development. Specification may change in any manner without notice.
Preliminary specification	Qualification	This data sheet contains preliminary data, and supplementary data will be published at a later date. Philips Semiconductors reserves the right to make changes at any time without notice in order to improve design and supply the best possible product.
Product specification	Production	This data sheet contains final specifications. Philips Semiconductors reserves the right to make changes at any time without notice in order to improve design and supply the best possible product.

[1] Please consult the most recently issued datasheet before initiating or completing a design.

Definitions

Short-form specification — The data in a short-form specification is extracted from a full data sheet with the same type number and title. For detailed information see the relevant data sheet or data handbook.

Limiting values definition — Limiting values given are in accordance with the Absolute Maximum Rating System (IEC 134). Stress above one or more of the limiting values may cause permanent damage to the device. These are stress ratings only and operation of the device at these or at any other conditions above those given in the Characteristics sections of the specification is not implied. Exposure to limiting values for extended periods may affect device reliability.

Application information — Applications that are described herein for any of these products are for illustrative purposes only. Philips Semiconductors make no representation or warranty that such applications will be suitable for the specified use without further testing or modification.

Disclaimers

Life support — These products are not designed for use in life support appliances, devices or systems where malfunction of these products can reasonably be expected to result in personal injury. Philips Semiconductors customers using or selling these products for use in such applications do so at their own risk and agree to fully indemnify Philips Semiconductors for any damages resulting from such application.

Right to make changes — Philips Semiconductors reserves the right to make changes, without notice, in the products, including circuits, standard cells, and/or software, described or contained herein in order to improve design and/or performance. Philips Semiconductors assumes no responsibility or liability for the use of any of these products, conveys no license or title under any patent, copyright, or mask work right to these products, and makes no representations or warranties that these products are free from patent, copyright, or mask work right infringement, unless otherwise specified.

Philips Semiconductors
811 East Arques Avenue
P.O. Box 3409
Sunnyvale, California 94088-3409
Telephone 800-234-7381

© Copyright Philips Electronics North America Corporation 1999
All rights reserved. Printed in U.S.A.

Date of release: 11-99

Document order number:

9397-750-06558

Let's make things better.