

## Interactive Catalog Replaces Catalog Pages

Honeywell Sensing and Control has replaced the PDF product catalog with the new **Interactive Catalog**. The **Interactive Catalog** is a power search tool that makes it easier to find product information. It includes more installation, application, and technical information than ever before.



**Click this icon to try the new  
Interactive Catalog.**

---

### **Sensing and Control**

Honeywell Inc.

11 West Spring Street

Freeport, Illinois 61032

# Basic Switches

## Standard

### STANDARD BASIC SWITCH CUT-A-WAY

The cut-a-way shown is representative of the standard basic switches described in this catalog.

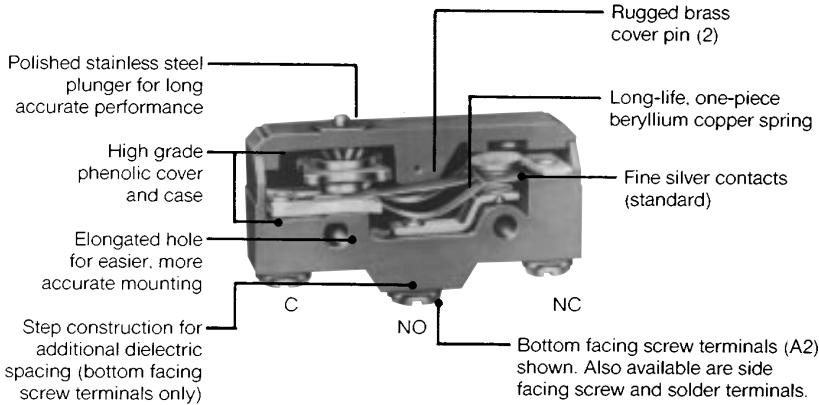

### FEATURES

- Operating force as low as 4 oz. (113 grams) maximum
- Sensitive differential travel as low as .0002 to .0003 inches (0,005 to 0,008 mm)
- Power load switching capability to 25 amperes
- Motor handling capacity to 2 horsepower at 250 VAC
- Long mechanical life
- High temperature constructions for up to +400°F (204°C)
- Momentary or maintained contact action
- Alloy contacts available for special application needs
- Variety of integral actuators
- Variety of auxiliary actuators
- Variety of terminal designs
- Optional sealed plunger and cover
- Stainless steel snap spring available
- Military standard construction available with over 50 listings on the MIL-S-8805 Qualified products list
- UL recognized, CSA certified

### GENERAL INFORMATION

MICRO SWITCH standard basic switches are precision snap-action mechanisms enclosed in accurately molded plastic cases. These switches are carefully manufactured and thoroughly inspected. They are industry known for their compactness, light weight, accurate repeatability and long life.

The type BZ switch design meets most applications needs. Modifications of the standard silver contact design and material, spring configuration, and plunger locations give the type BM, BA and BE switches greater electrical load handling capacity. Other changes in materials and switch design provide operating characteristics, temperature tolerances, and sealing to cover a wide range of special requirements.

### MOUNTING DIMENSIONS

Mounting dimensions are included at the end of each product section. They are shown in English and metric equivalents. These dimensions are for reference only. For exacting layout work, request an engineering layout work, request an engineering drawing from the 800 number.

### GENERAL SWITCH IDENTIFICATION

First letter in catalog listing designates:

- B = Single-pole double-throw
- W = Single-pole single-throw (normally closed)
- Y = Single-pole single-throw (normally open)

Second letter in catalog listing designates:

- Z = Standard 15-amp version
- M = 22-amp version
- A = Standard 20-amp version
- E = 25-amp version

Mounting holes for Types BZ, BM, BA, BE, DT, MT, and 6AS switches accept pins or screws of .139 inch (3,53 mm) diameter.

### RECOMMENDED TORQUE (max.)

- Mounting screws . . . . . 3 in./lbs.\*
- Terminal screws . . . . . 4 in./lbs.
- Panel mount bushing . . . . . 4-6 in./lbs.

\* Note: Tightening mounting screws above 3 in./lbs. changes operating characteristics and increases the possibility of cracking the case.

This section covers only **over 100** of our most popular BZ/BA type Series catalog listings. If you don't find what you're looking for, it's likely one of the approximately **1800** other active listings will meet your needs. Contact the 800 number.

### UL/CSA

Our basic switches are Component Recognized by Underwriters' Laboratories, Inc. and certified by Canadian Standards Association. The BA, BZ, and BM line is covered as Special Use Switches to UL Standard 1054; the BE line is covered as an Industrial Motor Controller to UL Standard 508.

Agency File References are:

BA	UL File E12252, issued 12-09-88
BM	UL File E12252, issued 12-08-88
BZ	UL File E12252, issued 6-29-89
BE-1,2,5	UL File E22779, Vol. 4, Sec. 1
BE-R	UL File E22779, Vol. 4, Sec. 2

Standard Basic Switches

# Basic Switches

## Standard

BZ/BA Series

### AVAILABLE TERMINALS

Most of the BZ/BA catalog listings have A2 type terminals. Several other terminal styles are shown and others are available. Specific information should be requested from the 800 number or local Authorized Distributor.

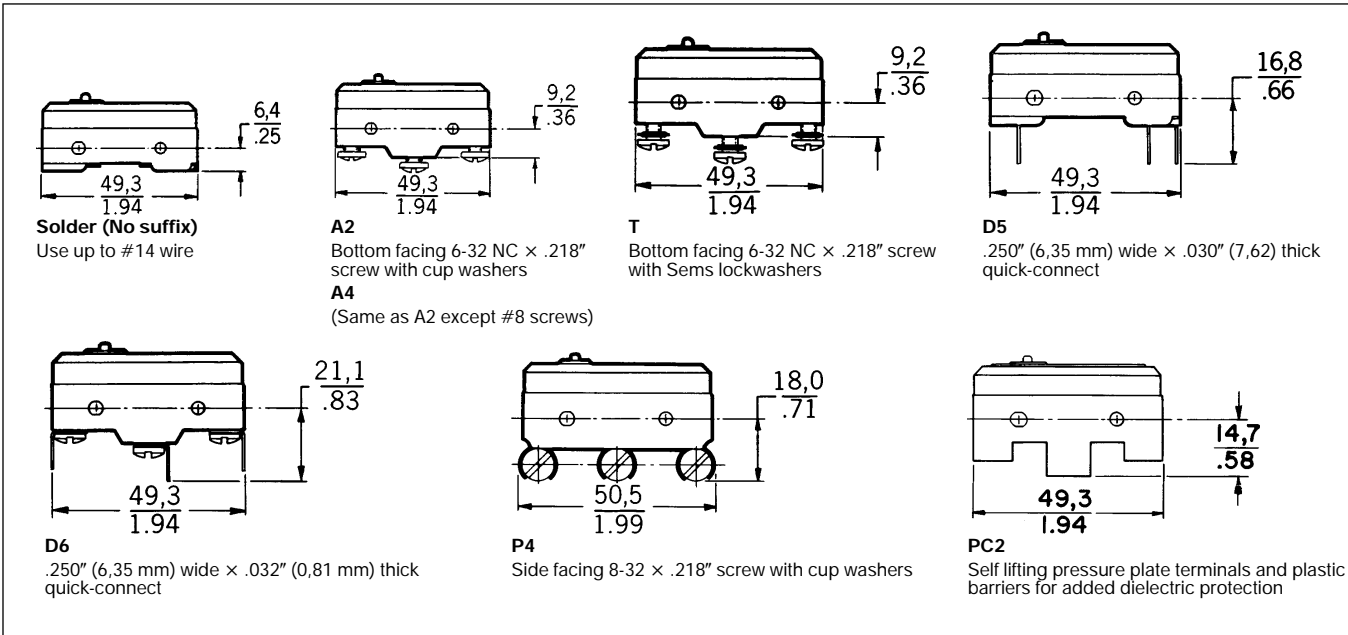

### ACTUATORS

BA, BE, BM and BZ standard basic switches use the actuators described.

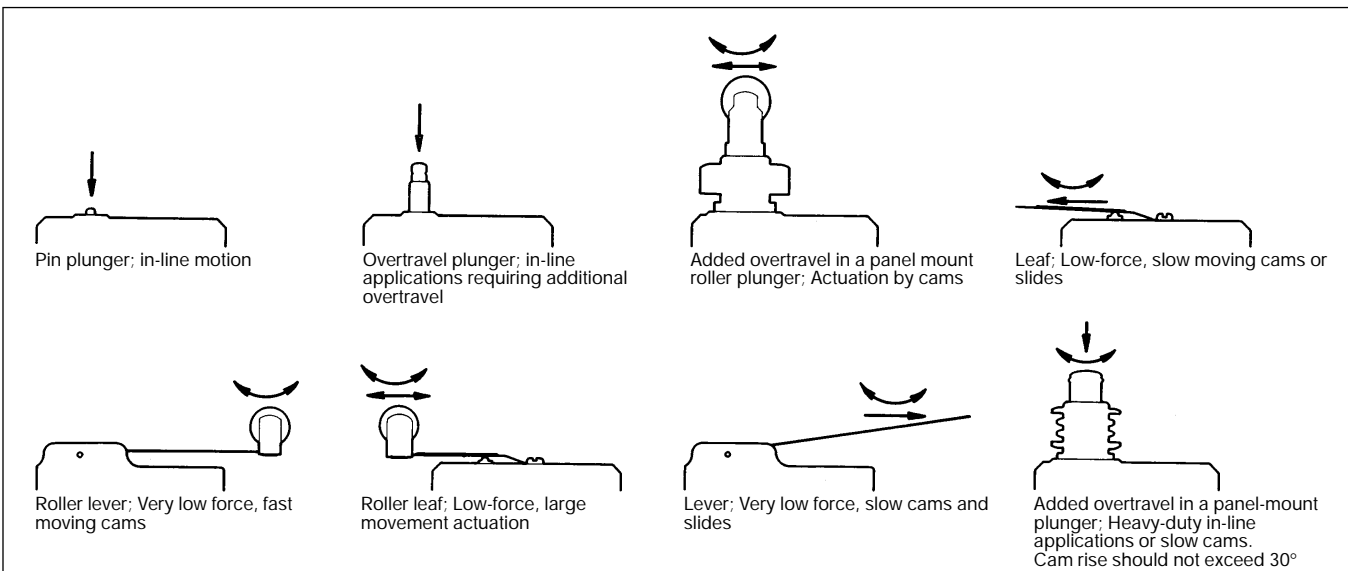

# Basic Switches

## Standard

## BZ/BA Series

**Characteristics:** O.F. — Operating Force; R.F. — Release Force; P.T. — Pretravel; O.T. — Overtravel; D.T. — Differential Travel; O.P. — Operating Position.

### ORDER GUIDE by ascending electrical capability

#### PIN PLUNGER

#### BZ/BA TYPE



Dim. Dwg. Fig. 1

#### SEALED TYPE



Dim. Dwg. Fig. 2

#### BA/BE TYPE



Dim. Dwg. Fig. 3



Dim. Dwg. Fig. 4

Catalog Listing	Recommended For	Electrical Data And UL Codes Page 46	O.F. newtons ounces	R.F. min. newtons ounces	P.T. max. mm inches	O.T. min. mm inches	D.T. mm inches	O.P.** mm inches
BZ-2R72-A2	Applications requiring gold alloy contacts	1 Amp <b>P</b>	2,5-3,61 <b>9-13</b>	1,11 <b>4</b>	0,38 <b>.015</b>	0,13 <b>.005</b>	0,01-0,05 <b>.0004-.0020</b>	15,88 <b>.625</b>
BZ-2R725551-A2	Gold alloy contacts Dustproof and splash resistant seal	1 Amp <b>P</b>	2,22-4,17 <b>8-15</b>	1,11 <b>4</b>	— <b>—</b>	0,13 <b>.005</b>	0,01-0,06 <b>.0004-.0025</b>	15,88 <b>.625</b>
BZ-2R244-A2	Operating in temp. to +400°F (204°C) for 100 hours	5 Amps <b>B</b>	2,5-3,61 <b>9-13</b>	1,11 <b>4</b>	0,38 <b>.015</b>	0,13 <b>.005</b>	0,01-0,05 <b>.0004-.0020</b>	15,88 <b>.625</b>
BZ-R21-A2	Lower force	10 Amps <b>C</b>	1,11 <b>4</b>	0,7 <b>2.5</b>	0,30 <b>.012</b>	0,13 <b>.005</b>	0,005-0,013 <b>.0002-.0005</b>	15,88 <b>.625</b>
BZ-2R-A2	Most applications SPDT	15 Amps <b>A</b>	2,5-3,61 <b>9-13</b>	1,11 <b>4</b>	0,38 <b>.015</b>	0,13 <b>.005</b>	0,01-0,05 <b>.0004-.0020</b>	15,88 <b>.625</b>
WZ-2R-A2	SPST (normally closed)	15 Amps <b>A</b>	2,5-3,61 <b>9-13</b>	1,11 <b>4</b>	0,38 <b>.015</b>	0,13 <b>.005</b>	0,01-0,05 <b>.0004-.0020</b>	15,88 <b>.625</b>
YZ-2R-A2	SPST (normally open)	15 Amps <b>A</b>	2,5-3,61 <b>9-13</b>	1,11 <b>4</b>	0,38 <b>.015</b>	0,13 <b>.005</b>	0,01-0,05 <b>.0004-.0020</b>	15,88 <b>.625</b>
BZ-R-A2	Less differential travel	15 Amps <b>D</b>	1,95-2,5 <b>7-9</b>	1,11 <b>4</b>	0,30 <b>.012</b>	0,13 <b>.005</b>	0,005-0,008 <b>.0002-.0003</b>	15,88 <b>.625</b>
BZ-R19-A2	Best repeatability	15 Amps <b>D</b>	1,95-3,34 <b>7-12</b>	1,11 <b>4</b>	0,30 <b>.012</b>	0,13-0,2 <b>.005-.008</b>	0,005-0,02 <b>.0002-.0008</b>	16,26 <b>.640</b>
BZ-2R24-A2	Operating in temp. to +250°F (121°C)	15 Amps <b>A</b>	2,5-3,61 <b>9-13</b>	1,11 <b>4</b>	0,38 <b>.015</b>	0,13 <b>.005</b>	0,01-0,05 <b>.0004-.0020</b>	15,88 <b>.625</b>
BZ-2RT04 (8805/1-004)	MIL-S-8805 application requirements	15 Amps <b>A</b>	2,5-3,61 <b>9-13</b>	1,67 <b>6</b>	0,38 <b>.015</b>	0,13 <b>.005</b>	0,01-0,05 <b>.0004-.0020</b>	15,88 <b>.625</b>
BZ-2R05-A2	Best stability under varying humidity	15 Amps <b>A</b>	2,5-3,61 <b>9-13</b>	1,11 <b>4</b>	0,38 <b>.015</b>	0,13 <b>.005</b>	0,01-0,05 <b>.0004-.0020</b>	15,88 <b>.625</b>
BZ-2R5551-A2	Dustproof and splash resistant seal	15 Amp <b>A</b>	2,5-4,17 <b>9-15</b>	1,11 <b>4</b>	— <b>—</b>	0,13 <b>.005</b>	0,01-0,06 <b>.0004-.0025</b>	15,88 <b>.625</b>
BZ-2R55-A2-S	Best service for sealed construction. Stainless steel internal snap spring.	15 Amps <b>A</b>	2,5-4,17 <b>9-15</b>	1,11 <b>4</b>	— <b>—</b>	0,13 <b>.005</b>	0,01-0,06 <b>.0004-.0025</b>	15,88 <b>.625</b>
BA-2R-A2	Up to 20 ampere load handling	20 Amps <b>G</b>	3,89-6,12 <b>14-22</b>	2,78 <b>10</b>	1,27 <b>.050</b>	0,25 <b>.010</b>	0,05-0,19 <b>.0020-.0075</b>	16,26 <b>.640</b>
BA-2R24-A2	Operating in temperature to +250°F (121°C)	20 Amps <b>G</b>	3,89-6,12 <b>14-22</b>	2,78 <b>10</b>	1,27 <b>.050</b>	0,25 <b>.010</b>	0,05-0,19 <b>.0020-.0075</b>	16,26 <b>.640</b>
BM-1R-A2	Up to 22 ampere load handling	22 Amps <b>F</b>	1,95-2,78 <b>7-10</b>	1,11 <b>4</b>	0,38 <b>.015</b>	0,13 <b>.005</b>	0,013-0,025 <b>.0005-.0010</b>	15,88 <b>.625</b>
BE-2R-A4	Up to 25 ampere load handling	25 Amps <b>H</b>	3,89-6,12 <b>14-22</b>	2,78 <b>10</b>	1,27 <b>.050</b>	0,25 <b>.010</b>	0,05-0,19 <b>.0020-.0075</b>	16,26 <b>.640</b>

Standard Basic Switches

BZ-RX	Manual reset (maintained contact) applications, solder terminals	15 Amps <b>E</b>	1,95-2,5 <b>7-9</b> 0,56-2,78* <b>2-10</b>	— <b>—</b> — <b>—</b>	0,30 <b>.012</b> — <b>—</b>	0,13 <b>.005</b> 0,38* <b>.015</b>	— <b>—</b>	15,88 <b>.625</b>
WA-1RX-A4	Manual reset SPST-NC, A4 terminals	20 Amps <b>W</b>	5,56 <b>20</b> 6,95* <b>25</b>	— <b>—</b> — <b>—</b>	— <b>—</b> — <b>—</b>	0,25 <b>.010</b> — <b>—</b>	0,20 <b>.008</b> — <b>—</b>	16,26 <b>.64</b> 27,9* <b>1.10</b>

\* Reset characteristics.

Except where stated \*\* ±0,38mm ±.015 in.

All catalog listings shown are not necessarily stock items. Stocking depends on sales experience.

Auxiliary actuators see p. 62-63.

# Basic Switches

## Standard

## BZ/BA Series

**Characteristics:** O.F. — Operating Force;  
 R.F. — Release Force; P.T. — Pretravel;  
 O.T. — Overtravel; D.T. — Differential Travel;  
 O.P. — Operating Position.

### OVERTRAVEL PLUNGER

### ORDER GUIDE

Catalog Listing	Recommended For	Electrical Data and UL Codes Page 46	O.F. newtons ounces	R.F. min. newtons ounces	P.T. max. mm inches	O.T. min. mm inches	D.T. mm inches	O.P.* mm inches
<b>BZ-2RD72-A2</b>	Applications requiring gold alloy contacts	1 Amp <b>P</b>	2,5-3,61 <b>9-13</b>	1,11 <b>4</b>	0,38 <b>.015</b>	1,52 <b>.060</b>	0,01-0,05 <b>.0004-.0020</b>	21,21 <b>.835</b>
<b>BZ-2RD-A2</b>	Added overtravel. For manual operation and slow 20° (max) cam rise	15 Amps <b>A</b>	2,5-3,61 <b>9-13</b>	1,11 <b>4</b>	0,38 <b>.015</b>	1,52 <b>.060</b>	0,01-0,05 <b>.0004-.0020</b>	21,21 <b>.835</b>
<b>BZ-2RD24-A2</b>	Operating in temperature to +250°F (121°C)	15 Amps <b>A</b>	2,5-3,61 <b>9-13</b>	1,11 <b>4</b>	0,38 <b>.015</b>	1,52 <b>.060</b>	0,01-0,05 <b>.0004-.0020</b>	21,21 <b>.835</b>
<b>BM-1RD-A2</b>	Up to 22 ampere load handling	22 Amps <b>F</b>	1,95-2,78 <b>7-10</b>	1,11 <b>4</b>	0,38 <b>.015</b>	1,52 <b>.060</b>	0,013-0,025 <b>.0005-.0010</b>	21,21 <b>.835</b>

<b>BZ-2RDS725551-A2</b>	Applications requiring gold alloy contacts plus dustproof and splash resistant seal	1 Amp <b>P</b>	3,61-5,28 <b>13-19</b>	1,11 <b>4</b>	—	1,52 <b>.060</b>	0,01-0,063 <b>.0004-.0025</b>	28,20 <b>1.110</b>
<b>BZ-2RDS5551-A2</b>	Dustproof and splash resistant seal	15 Amps <b>A</b>	3,61-5,28 <b>13-19</b>	1,11 <b>4</b>	—	1,52 <b>.060</b>	0,01-0,063 <b>.0004-.0025</b>	28,20 <b>1.110</b>

<b>BA-2RB-A2</b>	Up to 20 ampere load handling	20 Amps <b>G</b>	3,89-6,12 <b>14-22</b>	2,78 <b>10</b>	1,27 <b>.050</b>	2,39 <b>.094</b>	0,05-0,19 <b>.0020-.0075</b>	26,20 <b>1.03</b>
<b>BE-2RB-A4</b>	Up to 25 ampere load handling	25 Amps <b>H</b>	3,89-6,12 <b>14-22</b>	2,78 <b>10</b>	1,27 <b>.050</b>	2,39 <b>.094</b>	0,05-0,19 <b>.0020-.0075</b>	26,20 <b>1.03</b>

<b>BZ-2RS72-A2</b>	Applications requiring gold alloy contacts	1 Amp <b>P</b>	2,5-3,61 <b>9-13</b>	1,11 <b>4</b>	0,38 <b>.015</b>	1,52 <b>.060</b>	0,01-0,05 <b>.0004-.0020</b>	28,20 <b>1.110</b>
<b>BZ-2RS-A2</b>	Added overtravel. For in-line operation and with JR auxiliary actuators	15 Amps <b>A</b>	2,5-3,61 <b>9-13</b>	1,11 <b>4</b>	0,38 <b>.015</b>	1,52 <b>.060</b>	0,01-0,063 <b>.0004-.0025</b>	28,20 <b>1.110</b>
<b>BZ-2RS24-A2</b>	Operating in temperature to +250°F (121°C)	15 Amps <b>A</b>	2,5-3,61 <b>9-13</b>	1,11 <b>4</b>	0,38 <b>.015</b>	1,52 <b>.060</b>	0,01-0,05 <b>.0004-.0020</b>	28,20 <b>1.110</b>
<b>BZ-2RST04 M8805/1-012)</b>	MIL-S-8805 application requirements	15 Amps <b>A</b>	2,5-3,61 <b>9-13</b>	1,67 <b>6</b>	0,38 <b>.015</b>	1,52 <b>.060</b>	0,01-0,05 <b>.0004-.0020</b>	28,20 <b>1.110</b>
<b>BZ-RSX</b>	Manual reset solder terminals	15 Amps <b>E</b>	1,95-2,64 <b>7-9</b>	— —	0,30 <b>.012</b>	0,64 <b>.025</b>	— —	2,79 <b>1.11</b>
<b>BM-1RS-A2</b>	Up to 22 ampere load handling	22 Amps <b>F</b>	1,95-2,78 <b>7-10</b>	1,11 <b>4</b>	0,38 <b>.015</b>	1,52 <b>.060</b>	0,013-0,025 <b>.0005-.0010</b>	28,20 <b>1.110</b>

<b>BZ-2RS7225551-A2</b>	Applications requiring gold alloy contacts plus dustproof and splash resistant seal	1 Amp <b>P</b>	2,5-4,17 <b>9-15</b>	1,11 <b>4</b>	—	1,52 <b>.060</b>	0,01-0,063 <b>.0004-.0025</b>	28,20 <b>1.110</b>
<b>BZ-2RS5551-A2</b>	Dustproof and splash resistant seal	15 Amps <b>A</b>	2,5-4,17 <b>9-15</b>	1,11 <b>4</b>	—	1,52 <b>.060</b>	0,01-0,063 <b>.0004-.0025</b>	28,20 <b>1.110</b>

\*±0,51 mm  
±.020 in.



Dim. Dwg. Fig. 11



Dim. Dwg. Fig. 12



Dim. Dwg. Fig. 13



Dim. Dwg. Fig. 14



Dim. Dwg. Fig. 15

# Basic Switches

## Standard

# BZ/BA Series

### OVERTRAVEL PLUNGER



Dim. Dwg. Fig. 16

### ORDER GUIDE

Catalog Listing	Recommended For	Electrical Data and UL Codes Page 46	O.F. newtons ounces	R.F. min. newtons ounces	P.T. max. mm inches	O.T. min. mm inches	D.T. mm inches	O.P.** mm inches
<b>BZ-2RQ-A2</b>	Added overtravel. For manual in-line operation and for slow 30° (max) rise cams	15 Amps <b>A</b>	2,5-3,61 <b>9-13</b>	1,11 <b>4</b>	0,38 <b>.015</b>	5,56 <b>.219</b>	0,01-0,05 <b>.0004-.0020</b>	38,10±0,51 <b>1.500±.020</b>
<b>BZ-2RQ24-A2</b>	Operating in temperature to ±250°F (121°C)	15 Amps <b>A</b>	2,5-3,61 <b>9-13</b>	1,11 <b>4</b>	0,38 <b>.015</b>	5,56 <b>.219</b>	0,01-0,05 <b>.0004-.0020</b>	38,10±0,51 <b>1.500±.020</b>

### BZ/BM TYPE



Dim. Dwg. Fig. 17

### BA TYPE



Dim. Dwg. Fig. 18

<b>BZ-2RQ172-A2</b>	Applications requiring gold alloy contacts	1 Amp <b>P</b>	2,5-3,61 <b>9-13</b>	1,11 <b>4</b>	0,38 <b>.015</b>	5,56 <b>.219</b>	0,01-0,05 <b>.0004-.0020</b>	21,82 <b>.859</b>
<b>BZ-2RQ1-A2</b>	BZ-2RQ-A2 type applications with panel mount	15 Amps <b>A</b>	2,5-3,61 <b>9-13</b>	1,11 <b>4</b>	0,38 <b>.015</b>	5,56 <b>.219</b>	0,01-0,05 <b>.0004-.0020</b>	21,82 <b>.859</b>
<b>BZ-2RQ1T04 (M8805/1-020)</b>	MIL-S-8805 application requirements	15 Amps <b>A</b>	2,5-3,61 <b>9-13</b>	1,67 <b>6</b>	0,38 <b>.015</b>	5,56 <b>.219</b>	0,01-0,05 <b>.0004-.0020</b>	21,82 <b>.859</b>
<b>BZ-2RQ124-A2</b>	Operating in temperature to ±250°F (121°C)	15 Amps <b>A</b>	2,5-3,61 <b>9-13</b>	1,11 <b>4</b>	0,38 <b>.015</b>	5,56 <b>.219</b>	0,01-0,05 <b>.0004-.0020</b>	21,82 <b>.859</b>
<b>BZ-2RN702</b>	Furnished with unassembled seal boot.	15 Amps <b>X</b>	2,5-3,61 <b>9-13</b>	1,11 <b>4</b>	0,38 <b>0.15</b>	3,18 <b>.125</b>	0,01-0,05 <b>.0004-.0020</b>	48,4±0,50 <b>1.906±.020</b>
<b>BZ-RQ1X</b>	Manual reset. Solder terminals	15 Amps <b>E</b>	1,67-2,64 <b>6-9.5</b>	- <b>-</b>	0,30 <b>0.12</b>	5,56 <b>.219</b>	- <b>-</b>	23,42±1,14 <b>.922±.045</b> 7,14* .281*
<b>BA-2RQ1-A2</b>	Up to 20 ampere load handling	20 Amps <b>G</b>	3,89-6,12 <b>14-22</b>	2,78 <b>10</b>	1,27 <b>.050</b>	5,56 <b>.219</b>	0,05-0,19 <b>.0020-.0075</b>	21,82 <b>.859</b>
<b>BM-1RQ1-A2</b>	Up to 22 ampere load handling	22 Amps <b>F</b>	1,95-2,78 <b>7-10</b>	1,11 <b>4</b>	0,38 <b>.015</b>	5,56 <b>.219</b>	0,013-0,025 <b>.0005-.0010</b>	21,82 <b>.859</b>

Standard Basic Switches

<b>BZ-2RQ1872-A2</b>	Applications requiring gold alloy contacts	1 Amp <b>P</b>	2,5-3,61 <b>9-13</b>	1,11 <b>4</b>	0,38 <b>.015</b>	3,56 <b>.140</b>	0,01-0,05 <b>.0004-.0020</b>	33,32±1,14 <b>1.312±.045</b>
<b>BZ-2RQ18-A2</b>	Added overtravel. Roller plunger for rapid cam (30° max) rise and slide operation. Panel mount	15 Amps <b>A</b>	2,5-3,61 <b>9-13</b>	1,11 <b>4</b>	0,38 <b>.015</b>	3,56 <b>.140</b>	0,01-0,05 <b>.0004-.0020</b>	33,32±1,14 <b>1.312±.045</b>
<b>BZ-2RQ1824-A2</b>	Operating in temperature to ±250°F (121°C)	15 Amps <b>A</b>	2,5-3,61 <b>9-13</b>	1,11 <b>4</b>	0,38 <b>.015</b>	3,56 <b>.140</b>	0,01-0,05 <b>.0004-.0020</b>	33,32±1,14 <b>1.312±.045</b>
<b>BZ-2AQ18T1</b>	Double-break circuitry	15 Amps <b>T</b>	3,89-6,68 <b>14-24</b>	1,11 <b>4</b>	0,51 <b>.020</b>	3,58 <b>.141</b>	0,03-0,10 <b>.001-.004</b>	33,35±1,19 <b>1.313±.047</b>
<b>BM-1RQ18-A2</b>	Up to 22 ampere load handling	22 Amps <b>F</b>	1,95-2,78 <b>7-10</b>	1,11 <b>4</b>	0,38 <b>.015</b>	3,56 <b>.140</b>	0,013-0,025 <b>.0005-.0010</b>	33,32±1,14 <b>1.312±.045</b>

<b>BZ-2RQ181-A2</b>	Applications requiring roller plunger 90° to major axis of switch	15 Amps <b>A</b>	2,5-3,61 <b>9-13</b>	1,11 <b>4</b>	0,38 <b>.015</b>	3,56 <b>.140</b>	0,01-0,05 <b>.0004-.0020</b>	33,32±1,14 <b>1.312±.045</b>
---------------------	---	---------------------	-------------------------	------------------	---------------------	---------------------	---------------------------------	---------------------------------

\* Reset characteristics.

Except where stated \*\* ±0,76 mm ±.030 in.

# Basic Switches

## Standard

# BZ/BA Series

**Characteristics:** O.F. — Operating Force; R.F. — Release Force;  
P.T. — Pretravel; O.T. — Overtravel; D.T. — Differential Travel;  
O.P. — Operating Position.

### STRAIGHT LEVER

### ORDER GUIDE

#### BZ/BM TYPE



Dim. Dwg. Fig. 21

#### BA TYPE



Dim. Dwg. Fig. 23

#### ADJUSTABLE



Dim. Dwg. Fig. 22



Dim. Dwg. Fig. 24

Catalog Listing	Recommended For	Electrical Data and UL Codes Page 46	O.F. max. newtons ounces	R.F. min. newtons ounces	P.T. max. mm inches	O.T. min. mm inches	D.T. mm inches	O.P.** mm inches
BZ-2RW8072-A2	Applications requiring gold alloy contacts	1 Amp P	0,7 2.5	0,14 0.5	—	5,56 .219	0,18-1,27 .007-.050	19,1 .750
BZ-2RW80722555105-A2	Best stability under varying humidity. Gold alloy contacts with seal	1 Amp P	0,7 2.5	0,14 0.5	—	5,56 .219	0,18-1,27 .007-.050	19,1 .750
BZ-2RW8244-A2	Operating in temp. to +400°F (204°C) for 100 hours	5 Amps B	0,7 2.5	0,14 0.5	—	5,56 .219	0,18-1,27 .007-.050	19,1 .750
BZ-RW8435-A2	Lowest operating force (without external return spring)	10 Amps I	0,07 .25	—	6,76 .266	5,56 .219	0,08-0,38 .003-.015	19,1 .750
BZ-2RW876T	1.25 inch lever requirements	15 Amps A	1,67 6	0,42 1.5	—	0,42 .141	0,10-0,63 .004-.025	19,1 .750
BZ-2RW80-A2	2.5 inch lever requirements	15 Amps A	0,7 2.5	0,14 0.5	—	5,56 .219	0,18-1,27 .007-.050	19,1 .750
BZ-2RW84-A2	Lower force (without external return spring)	15 Amps A	0,28 1	0,03 0.125	8,33 .328	5,56 .219	0,18-1,27 .007-.050	19,1 .750
BZ-2RW805551-A2	Dustproof and splash resistant seal	15 Amps A	0,7 2.5	0,14 0.5	—	5,56 .219	0,18-1,27 .007-.050	19,1 .750
BZ-2RWT04 (M8805/1-044)	ML-S-8805 application requirements	15 Amps A	0,28-0,90 1-3.25	0,21 0.75	7,52 .296	4,37 .172	2,36 .093	19,1 .750
BZ-2RW824-A2	Operating in temperature to +250°F (121°C)	15 Amps A	0,7 2.5	0,14 0.5	—	5,56 .219	0,18-1,27 .007-.050	19,1 .750
BZ-RW80X	Manual reset solder terminals	15 Amps E	0,63 2.25	—	—	5,56 .219	— —	19,05 .750
						0,38* .015	- -	7,14* .281
BZ-2RW863-A2	6 inch lever requirements	15 Amps A	0,28 1	—	—	12,7 .500	0,46-3,68 .018-.145	19,1±1,52 .750±.060
BA-2RV-A2	Up to 20 ampere load handling	20 Amps G	0,7 2.5	0,14 0.5	15,88 .625	1,98 .078	2,77 .109	19,1 .750
BM-1RW84-A2	Up to 22 ampere load handling	22 Amps F	0,28 1	0,03 0.125	7,54 .297	5,56 .219	0,13-0,84 .005-.033	19,1 .750
BE-2RV-A4	Up to 25 ampere load handling	25 Amps H	0,7 2.5	0,14 0.5	15,88 .625	1,98 .078	2,77 .109 max.	19,1 .750

\* Reset characteristics.

BZ-2RW899-A2	Adjustable operating point (17 mm to 22 mm) .670" to .880"	15 Amps A	0,7 2.5	0,14 0.5	—	3,54† .125	0,18-1,27 .007-.050	17,02-22,35 .670-.880
--------------	--	--------------	------------	-------------	---	---------------	------------------------	--------------------------

BZ-2RM-A2	Reverse acting actuator (switch plunger depressed in free position)	15 Amps A	1,67 6	0,28 1	5,56 .219	5,56 .219	0,10-0,89 .004-.035	19,1 .750
-----------	---	--------------	-----------	-----------	--------------	--------------	------------------------	--------------

† From  $\frac{17}{670}$  mm O.P.

Except where stated \*\* ±0.76 mm ±.030 in.

### SIMULATED ROLLER



Dim. Dwg. Fig. 27

### ORDER GUIDE

Catalog Listing	Recommended For	Electrical Data And UL Code Page 46	O.F. max. newtons ounces	R.F. min. newtons ounces	P.T. max. mm inches	O.T. min. mm inches	D.T. mm inches	O.P.** mm inches
<b>BZ-2RW80147-A2</b>	1.05 inch (26,7 mm) (simulated roller) lever applications	15 Amps <b>A</b>	1,67 <b>6</b>	0,42 <b>1.5</b>	—	2,39 <b>.094</b>	0,08-0,51 <b>.003-.020</b>	30,17 <b>1.188</b>
<b>BZ-2RW80196-A2</b>	1.90 inch (48,3 mm) (simulated roller) lever applications	15 Amps <b>A</b>	0,97 <b>3.5</b>	0,21 <b>0.75</b>	—	3,96 <b>.156</b>	0,10-1,0 <b>.004-.040</b>	30,17±0,76 <b>1.188±.030</b>

### ROLLER LEVER

#### BZ/BM TYPE



Dim. Dwg. Fig. 25



Dim. Dwg. Fig. 28

#### BA/BE TYPE



Dim. Dwg. Fig. 26

<b>BZ-2RW82272-A2</b>	Applications requiring gold alloy contacts	1 Amp <b>P</b>	1,67 <b>6</b>	0,42 <b>1.5</b>	—	2,39 <b>.094</b>	0,08-0,51 <b>.003-.020</b>	30,17 <b>1.188</b>
<b>BZ-2RW822725551-A2</b>	Applications requiring gold alloy contacts plus dustproof and splash resistant seal	1 Amp <b>P</b>	1,67 <b>6</b>	0,42 <b>1.5</b>	—	2,39 <b>.094</b>	0,08-0,51 <b>.003-.020</b>	30,17 <b>1.188</b>
<b>BZ-2RW822-A2</b>	1.05 inch (26,7 mm) (steel roller) lever applications	15 Amps <b>A</b>	1,67 <b>6</b>	0,42 <b>1.5</b>	—	2,39 <b>.094</b>	0,08-0,51 <b>.003-.020</b>	30,17 <b>1.188</b>
<b>BZ-2RW8222-A2</b>	Roller turned 90°	15 Amps <b>A</b>	0,7-1,81 <b>2.5-6.5</b>	0,35 <b>1.25</b>	—	3,58 <b>.141 max.</b>	0,08-0,51 <b>.003-.020</b>	30,75 <b>1.25</b>
<b>BZ-2RW82224-A2</b>	Operating in temperature to +250°F (121°C)	15 Amps <b>A</b>	1,67 <b>6</b>	0,42 <b>1.5</b>	—	2,39 <b>.094</b>	0,08-0,51 <b>.003-.020</b>	30,17 <b>1.188</b>
<b>BZ-2RW8225551-A2</b>	Dustproof and splash resistant seal	15 Amps <b>A</b>	1,67 <b>6</b>	0,42 <b>1.5</b>	—	2,39 <b>.094</b>	0,08-0,51 <b>.003-.020</b>	30,17 <b>1.188</b>
<b>BZ-2RW82255-A2-S</b>	Best service for sealed construction. Stainless steel internal snap spring.	15 Amps <b>A</b>	1,67 <b>6</b>	0,42 <b>1.5</b>	—	2,39 <b>.094</b>	0,08-0,51 <b>.003-.020</b>	30,17 <b>1.188</b>
<b>BA-2RV22-A2</b>	Up to 20 ampere load handling	20 Amps <b>G</b>	1,67 <b>6</b>	0,42 <b>1.5</b>	6,35 <b>.250</b>	0,76 <b>.030</b>	1,14 <b>.045 max.</b>	29,77 <b>1.172</b>
<b>BM-1RW822-A2</b>	Up to 22 ampere load handling	22 Amps <b>F</b>	1,67 <b>6</b>	0,42 <b>1.5</b>	—	2,39 <b>.094</b>	0,025-0,33 <b>.001-.013</b>	30,17 <b>1.188</b>
<b>BE-2RV22-A4</b>	Up to 25 ampere load handling	25 Amps <b>H</b>	1,67 <b>6</b>	0,42 <b>1.5</b>	6,35 <b>.250</b>	0,76 <b>.030</b>	1,14 <b>.045 max.</b>	29,77 <b>1.172</b>

<b>BZ-2RW82299-A2</b>	Adjustable operating point. Roller lever 1.05 inch (26,7 mm)	15 Amps <b>A</b>	1,67 <b>6</b>	0,42 <b>1.5</b>	—	1,02 <b>.040</b>	0,08-0,51 <b>.003-.020</b>	29,77-30,56 <b>1.172-1.203</b>
<b>BZ-2RW8299-A2</b>	Adjustable operating point. Roller lever 1.90 inch (48,3 mm)	15 Amps <b>A</b>	0,97 <b>3.5</b>	0,21 <b>0.75</b>	—	2,16 <b>.085</b>	0,10-1,0 <b>.004-.040</b>	29,2-31,5 <b>1.150-1.24</b>

Standard  
Basic Switches

Except where stated \* ±0,38 mm  
±.015 in.



### Characteristics:

O.F. — Operating Force; R.F. — Release Force; P.T. — Pretravel;

O.T. — Overtravel; D.T. — Differential Travel;

O.P. — Operating Position.

### ROLLER LEVER

### ORDER GUIDE

#### BZ/BM TYPE



Dim. Dwg. Fig. 29

#### BA/BE TYPE



Dim. Dwg. Fig. 30



Dim. Dwg. Fig. 31



Dim. Dwg. Fig. 32

Catalog Listing	Recommended For	Electrical Data And UL Code Page 46	O.F. max. newtons ounces	R.F. min. newtons ounces	P.T. max. mm inches	O.T. min. mm inches	D.T. mm inches	O.P.* mm inches
<b>BZ-2RW82725551-A2</b>	Applications requiring gold alloy contacts, plus dustproof, and splash resistant seal	1 Amp <b>P</b>	0,97 <b>3.5</b>	0,21 <b>0.75</b>	—	3,96 <b>.156</b>	0,10-1,0 <b>.004-.040</b>	30,17±0,76 <b>1.188±.030</b>
<b>BZ-2RW82-A2</b>	1.90 inch (48,3 mm) (steel roller) lever applications	15 Amps <b>A</b>	0,97 <b>3.5</b>	0,21 <b>0.75</b>	—	3,96 <b>.156</b>	0,10-1,0 <b>.004-.040</b>	30,17±0,76 <b>1.188±.030</b>
<b>BZ-2RW825551-A2</b>	Dustproof and splash resistant seal	15 Amps <b>A</b>	0,97 <b>3.5</b>	0,21 <b>0.75</b>	—	3,96 <b>.156</b>	0,10-1,0 <b>.004-.040</b>	30,17±0,76 <b>1.188±.030</b>
<b>BZ-2RW8224-A2</b>	Operating in temperature to +250°F (121°C)	15 Amps <b>A</b>	0,97 <b>3.5</b>	0,21 <b>0.75</b>	—	3,96 <b>.156</b>	0,10-1,0 <b>.004-.040</b>	30,17±0,76 <b>1.188±.030</b>
<b>BA-2RV2-A2</b>	Up to 20 ampere load handling	20 Amps <b>G</b>	0,97 <b>3.5</b>	0,14 <b>0.5</b>	11,89 <b>.468</b>	1,52 <b>.060</b>	2,16 <b>.085</b>	30,17±0,76 <b>1.188±.030</b>
<b>BM-1RW82-A2</b>	Up to 22 ampere load handling	22 Amps <b>F</b>	0,97 <b>3.5</b>	0,21 <b>0.75</b>	—	3,96 <b>.156</b>	0,08-0,56 <b>.003-.022</b>	30,17±0,76 <b>1.188±.030</b>
<b>BE-2RV2-A4</b>	Up to 25 ampere load handling	25 Amps <b>H</b>	0,97 <b>3.5</b>	0,14 <b>0.5</b>	11,89 <b>.468</b>	1,52 <b>.060</b>	2,16 <b>.085 max.</b>	30,17±0,76 <b>1.188±.030</b>

NOTE: For adjustable operate point and simulated roller lever switches, refer to previous page.

<b>BZ-RW922-A2</b>	Best repeatability and O.P. stability	10 Amps <b>I</b>	3,34 <b>12</b>	1,11 <b>4</b>	0,38 <b>.015</b>	2,54 <b>.100</b>	0,013-0,025 <b>.0005-.0010</b>	31,37 <b>1.235</b>
--------------------	---------------------------------------	---------------------	-------------------	------------------	---------------------	---------------------	-----------------------------------	-----------------------

<b>BZ-2RW826-A2</b>	One-way roller (9,4 mm × 3,8 mm) .37" dia. × .15" wide roller	15 Amps <b>A</b>	1,67 <b>6</b>	0,42 <b>1.5</b>	—	2,39 <b>.094</b>	0,08-0,51 <b>.003-.020</b>	41,34 <b>1.625</b>
<b>BZ-2RW825-A2</b>	One-way roller (4,83 mm × 4,83 mm) .19" dia. × .19" wide roller	15 Amps <b>A</b>	2,22 <b>8</b>	0,42 <b>1.5</b>	—	1,52 <b>.060</b>	0,38 <b>.015</b>	28,96 <b>1.14</b>

Except where stated \* ±0,38 mm ±.015 in.

# Basic Switches

## Standard

BZ/BA Series

### FLEXIBLE LEAF

### ORDER GUIDE

Catalog Listing	Recommended For	Electrical Data and UL Codes Page 46	O.F. max. newtons ounces	R.F. min. newtons ounces	P.T. max. mm inches	O.T. min. mm inches	D.T. max. mm inches	O.P.** mm inches
<b>BZ-2RL-A2</b>	Force and stability of the flexible leaf actuator	15 Amps <b>A</b>	1,39 <b>5</b>	0,14 <b>0.5</b>	-	1,52 <b>.060</b>	1,27 <b>.050</b>	17,48 <b>.688</b>
<b>BZ-2RL5551-A2</b>	Dustproof and splash resistant seal	15 Amps <b>A</b>	1,95 <b>7</b>	0,14 <b>0.5</b>	-	1,52 <b>.060</b>	1,27 <b>.050</b>	17,48 <b>.688</b>
<b>BZ-2RLT04 (M8805/1-001)</b>	MIL-S-8805 application requirements	15 Amps <b>A</b>	1,39 <b>5</b>	0,14 <b>0.5</b>	-	1,52 <b>.060</b>	1,27 <b>.050</b>	17,48 <b>.688</b>
<b>BZ-2RL24-A2</b>	Operating in temperature to +250°F (121°C)	15 Amps <b>A</b>	1,39 <b>5</b>	0,14 <b>0.5</b>	-	1,52 <b>.060</b>	1,27 <b>.050</b>	17,48 <b>.688</b>
<b>BZ-RLX</b>	Manual reset. Solder terminals	15 Amps <b>E</b>	0,83 <b>3</b>	- -	- -	1,57 <b>.062</b> 0,38* <b>.015</b>	- - -	17,48 <b>.688</b> 7,14* <b>.281</b>
<b>BA-2RL-A2</b>	Up to 20 ampere load handling	20 Amps <b>G</b>	2,5 <b>9</b>	0,28 <b>1</b>	-	1,57 <b>.062</b>	1,57 <b>.062</b>	17,48 <b>.688</b>
<b>BE-2RL-A4</b>	Up to 25 ampere load handling	25 Amps <b>H</b>	2,5 <b>9</b>	0,28 <b>1</b>	-	1,57 <b>.062</b>	1,57 <b>.062</b>	17,48 <b>.688</b>

#### BZ TYPE



Dim. Dwg. Fig. 33

#### BA/BE TYPE



Dim. Dwg. Fig. 34

### FLEXIBLE ROLLER LEAF

### ORDER GUIDE

Catalog Listing	Recommended For	Electrical Data and UL Codes Page 46	O.F. max. newtons ounces	R.F. min. newtons ounces	P.T. max. mm inches	O.T. min. mm inches	D.T. max. mm inches	O.P.* mm inches
<b>BZ-RL24-A2</b>	Operating in temp. to +250°F (121°C) for 100 hours	5 Amps <b>B</b>	1,39 <b>5</b>	0,14 <b>0.5</b>	-	1,52 <b>.060</b>	1,27 <b>.050</b>	28,6 <b>1.125</b>
<b>BZ-2RL2-A2</b>	Force and stability of the flexible leaf with roller	15 Amps <b>A</b>	1,39 <b>5</b>	0,14 <b>0.5</b>	-	1,52 <b>.060</b>	1,27 <b>.050</b>	28,6 <b>1.125</b>
<b>BZ-2RL25551-A2</b>	Dustproof and splash resistant seal	15 Amps <b>A</b>	1,95 <b>7</b>	0,14 <b>0.5</b>	-	1,52 <b>.060</b>	1,27 <b>.050</b>	28,6 <b>1.125</b>
<b>BZ-2RL2T04 (M8805/1-036)</b>	MIL-S-8805 application requirements	15 Amps <b>A</b>	1,04-1,39 <b>3.75-5</b>	0,14 <b>0.5</b>	-	1,52 <b>.060</b>	1,27 <b>.050</b>	28,6 <b>1.125</b>
<b>BA-2RL2-A2</b>	Up to 20 ampere load handling	20 Amps <b>G</b>	2,5 <b>9</b>	0,28 <b>1</b>	-	1,52 <b>.060</b>	1,65 <b>.065</b>	28,6 <b>1.125</b>
<b>BE-2RL2-A4</b>	Up to 25 ampere load handling	25 Amps <b>H</b>	2,5 <b>9</b>	0,28 <b>1</b>	-	1,52 <b>.060</b>	1,65 <b>.065</b>	28,6 <b>1.125</b>

#### BZ TYPE



Dim. Dwg. Fig. 35

#### BA/BE TYPE



Dim. Dwg. Fig. 36

\* Reset characteristics

\*\* ±0.76 mm  
±.030 in.

Standard Basic Switches

### GENERAL INFORMATION SPECIAL CIRCUITRY SWITCHES

"Special sequence" switches provide unusual circuit control. A make-before-break switch provides circuit continuity while switching from N.C. to N.O. In another make-before-make switch, upon actuation, one circuit is made an interval before the second circuit. Another switch

provides a single pulse or momentary closure of the contacts with each cycle of operation.

Double break versions can interrupt greater inductive loads and feature shorting bar construction. A split contact version allows control of the two isolated circuits.



**Characteristics:** O.F. – Operating Force;  
R.F. – Release Force; P.T. – Pretravel;  
O.T. – Overtravel; D.T. – Differential Travel;  
O.P. – Operating Position.

### PIN PLUNGER

#### ORDER GUIDE



Dim. Dwg. Fig 5

Catalog Listing	Recommended For	Electrical Data and UL Codes Page 46	O.F. newtons ounces	R.F. min. newtons ounces	P.T. max. mm inches	O.T. min. mm inches	D.T. mm inches	O.P.* mm inches
BZ-2G-A2	Make-before-break contact action	10 Amps C	5,56 20 max.	2,22 8	0,76 .030	0,13 .005	0,38 .015	15,9 .625

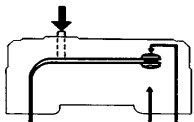

Unoperated

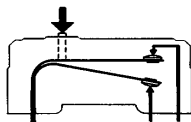

Intermediate

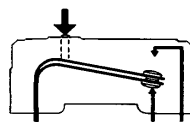

Fully Operated

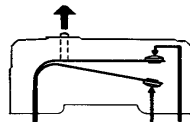

Intermediate Release

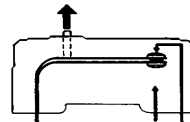

Fully Released



Dim. Dwg. Fig. 6

6BS1-B	Make-before-make contact action	10 Amps R	9,73 35 max.	2,78 10	-	-	-	-
--------	---------------------------------	--------------	-----------------	------------	---	---	---	---

\*±0,38 mm  
± .015 in.

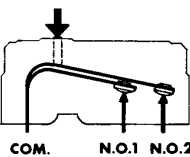
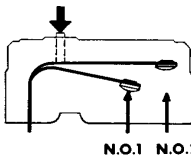
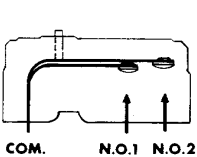

Dim. Dwg. Fig. 4-A

10BS210	Adjustable differential travel	20 Amps Y	3,10-5,56 11-20	2,78 10	-	0,25 .010 at max. setting	0,04-0,06 .0015-.0025 0,18 .007 at max. setting	16,3 .64
---------	--------------------------------	--------------	--------------------	------------	---	------------------------------	--	-------------

# Basic Switches

## Standard

BZ/BA Series

PIN PLUNGER —  
SPECIAL CIRCUITRY

### ORDER GUIDE



Dim. Dwg. Fig. 8

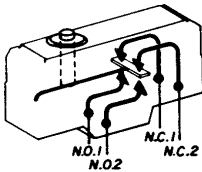

Dim. Dwg. Fig. 9

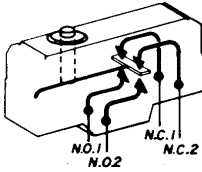

Dim. Dwg. Fig. 10

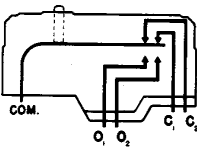

Catalog Listing	Recommended For	Electrical Data and UL Codes Page 46	O.F. newtons ounces	R.F. min. newtons ounces	P.T. max. mm inches	O.T. min. mm inches	D.T. mm inches	O.P.* mm inches
<b>BZ-3AT</b>	Double-break, low voltage DC applications	15 Amps <b>T</b>	4,45-7,23 <b>16-26</b>	1,11 <b>4</b>	0,76 <b>.030</b>	0,13 <b>.005</b>	0,051-0,13 <b>.002-.005</b>	15,9 <b>.625</b>
<b>BZ-2AW80T</b>	As above, with 2.5 inch lever	15 Amps <b>T</b>	0,90 <b>3.25</b>	0,14 <b>.25</b>	- <b>-</b>	5,56 <b>.219</b>	0,51 <b>2.54</b>	19,05±0,76 <b>.750±.030</b>
<b>BZ-2AW82T</b>	As above, with 1.9 inch roller lever	15 Amps <b>T</b>	1,25 <b>4.5</b>	0,21 <b>.75</b>	- <b>-</b>	3,96 <b>.156</b>	0,38-1,91 <b>.015-.075</b>	30,18±0,76 <b>1.188±.030</b>
<b>BZ-2AW822T</b>	As above, with 1.05 inch roller lever	15 Amps <b>T</b>	2,36 <b>8.5</b>	0,42 <b>1.5</b>	- <b>-</b>	2,39 <b>.094</b>	0,20-2,39 <b>.008-.030</b>	30,18±0,76 <b>1.188±.030</b>

<b>BA-3ST</b>	Double-break, low voltage DC applications	25 Amps <b>M</b>	7,23-10,6 <b>26-38</b>	2,78 <b>10</b>	1,65 <b>.065</b>	0,25 <b>.010</b>	0,18-0,38 <b>.007-.015</b>	16,3 <b>.640</b>
---------------	---	---------------------	---------------------------	-------------------	---------------------	---------------------	-------------------------------	---------------------

<b>BZ-3YT (MS25383-1)</b>	MIL-S-8805 application requirements. (split contact)	5 Amps <b>U</b>	4,45-7,23 <b>16-26</b>	1,11 <b>4</b>	0,76 <b>.030</b>	0,13 <b>.005</b>	0,025-0,1 <b>.001-.004</b>	15,9 <b>.625</b>
<b>BZ-3YWT80</b>	As above, with 2.50 inch lever	5 Amps <b>U</b>	0,97 <b>3.5</b>	0,14 <b>.5</b>	- <b>-</b>	5,56 <b>.219</b>	0,51-2,54 <b>.020-.100</b>	19,05±0,76 <b>.750±.030</b>
<b>BZ-3YWT82</b>	As above, with 1.9 inch roller lever	5 Amps <b>U</b>	1,25 <b>4.5</b>	0,21 <b>.75</b>	- <b>-</b>	3,96 <b>.156</b>	0,38-1,91 <b>.015-.075</b>	30,18±0,76 <b>1.188±.030</b>
<b>BZ-3YWT822</b>	As above, with 1.05 inch roller lever	5 Amps <b>U</b>	1,95 <b>7</b>	0,42 <b>1.5</b>	- <b>-</b>	2,39 <b>.094</b>	0,20-1,02 <b>.008-.040</b>	30,19 <b>.188</b>

Except where stated \* ±0,38 mm  
±.015 in.

Standard  
Basic Switches

# Basic Switches

## Standard

# BZ/BA Series

### MOUNTING DIMENSIONS (For reference only)

#### PIN PLUNGERS

BZ/BM

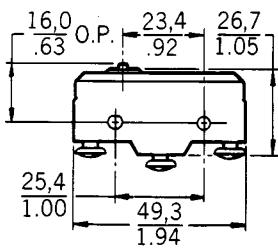

Fig. 1

BA/BE

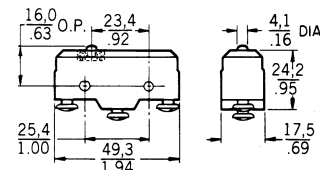

Fig. 2

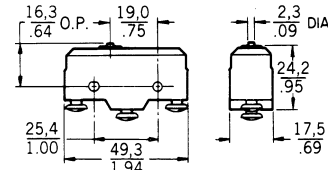

Fig. 3

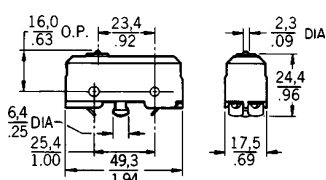

Fig. 4

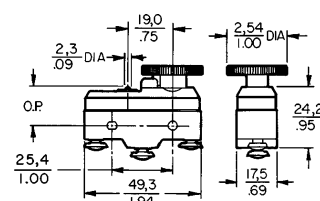

Fig. 4-A

#### PIN PLUNGERS — SPECIAL CIRCUITRY

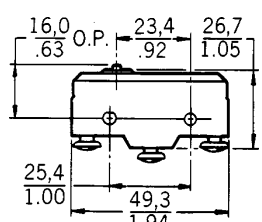

Fig. 5

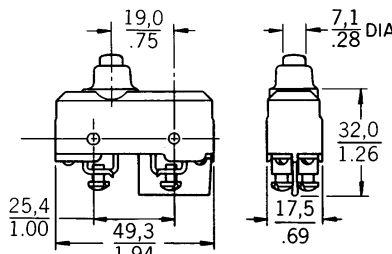

Fig. 6

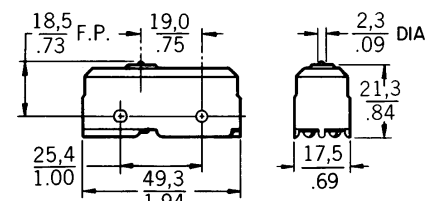

Fig. 7

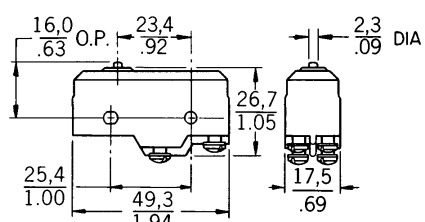

Fig. 8

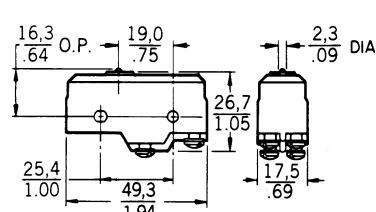

Fig. 9

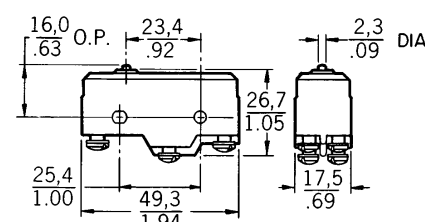

Fig. 10

Mounting holes accept pins or screws of .139" (3.53 mm) diameter.

Key: 0.0 = mm  
0.00 = inches

# Basic Switches Standard

BZ/BA Series

MOUNTING DIMENSIONS (For reference only)

## OVERTRAVEL PLUNGERS

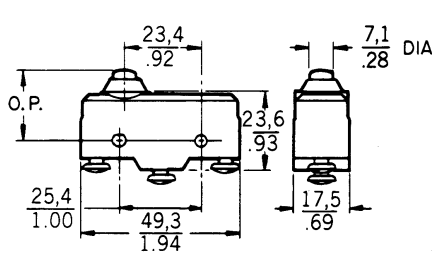

Fig. 11

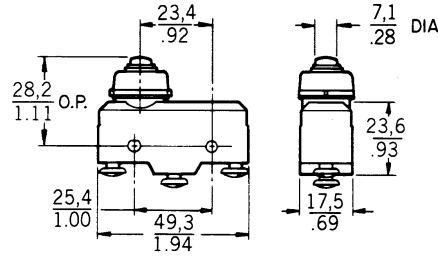

Fig. 12

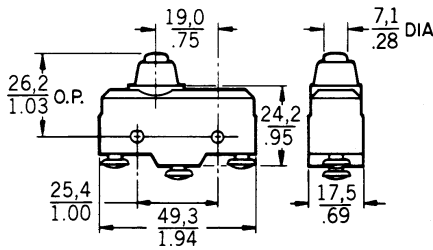

Fig. 13

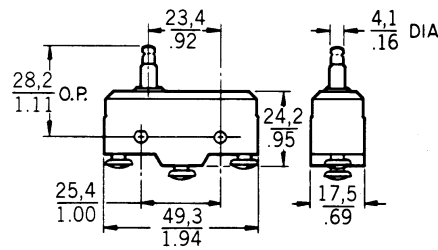

Fig. 14

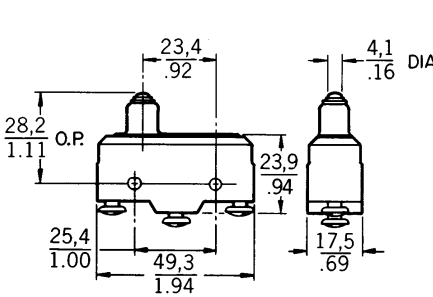

Fig. 15

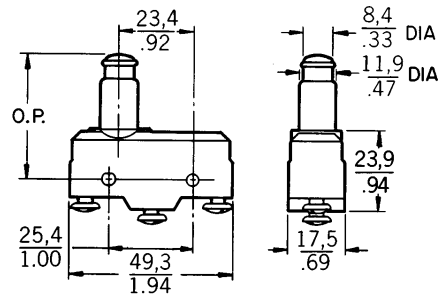
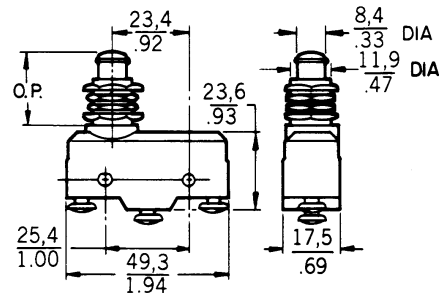
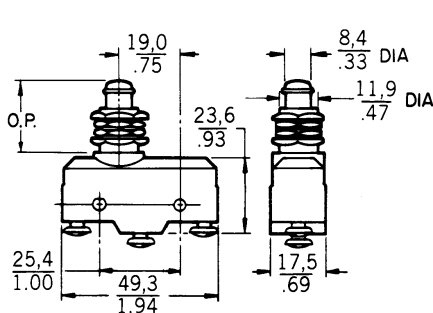

Fig. 16



\*Fig. 17



\*Fig. 18

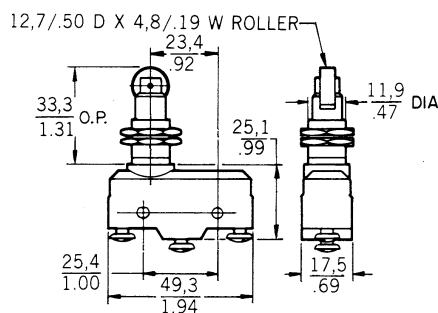

\*Fig. 19

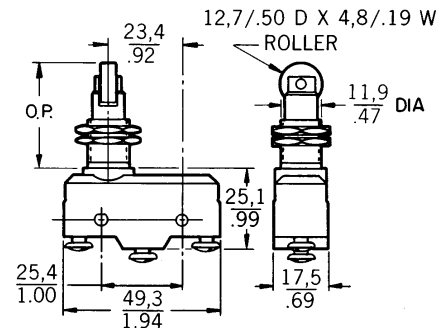

\*Fig. 20

Standard  
Basic Switches

\* Threaded bushings are 15/32-32ns.

# Basic Switches

## Standard

BZ/BA Series

MOUNTING DIMENSIONS (For reference only)

### STRAIGHT LEVERS

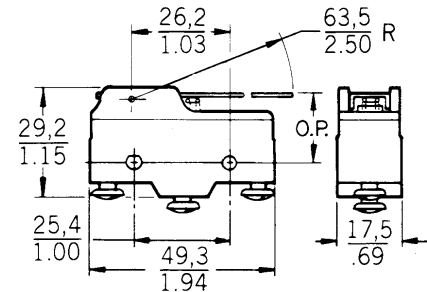

Fig. 21

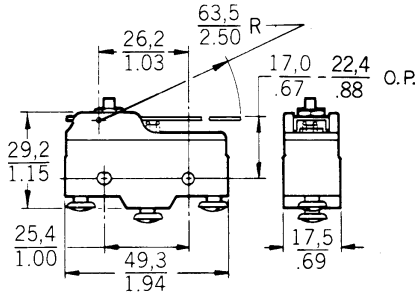

Fig. 22

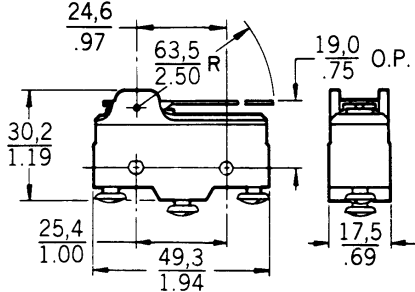

Fig. 23

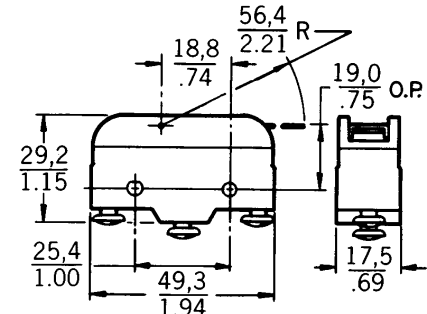

Fig. 24

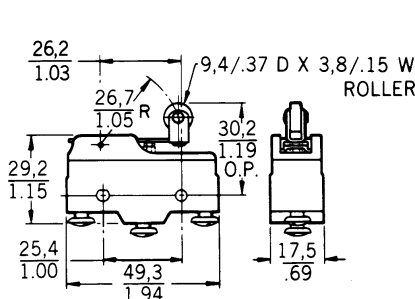

Fig. 25

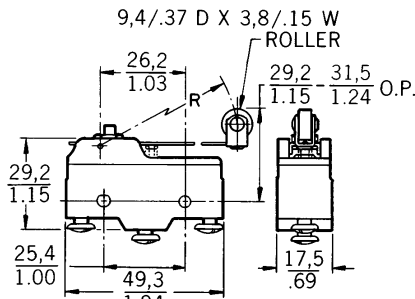

Fig. 26

R = 26,7/1.05 FOR BZ-2RW82299-A2  
48,3/1.90 FOR BZ-2RW8299-A2

### FLEXIBLE LEAF ACTUATOR

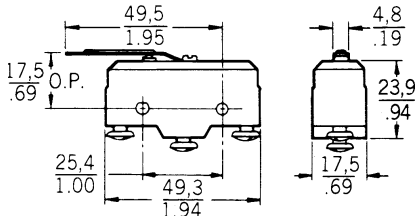

Fig. 33

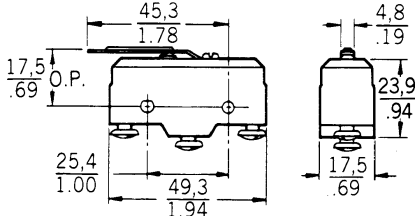

Fig. 34

# Basic Switches

## Standard

BZ/BA Series

### MOUNTING DIMENSIONS

### ROLLER LEVERS

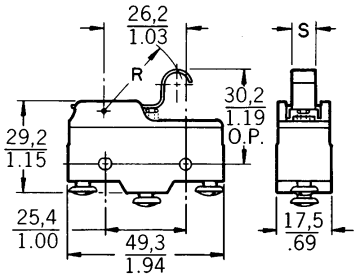

R = 26,7/1.05 FOR BZ-2RW80147-A2  
48,3/1.90 FOR BZ-2RW80196-A2

S = 7,9/0.31 FOR BZ-2RW80147-A2  
4,8/0.19 FOR BZ-2RW80196-A2

Fig. 27

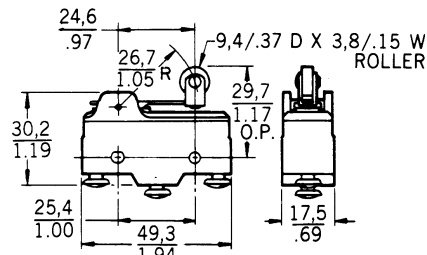

Fig. 28

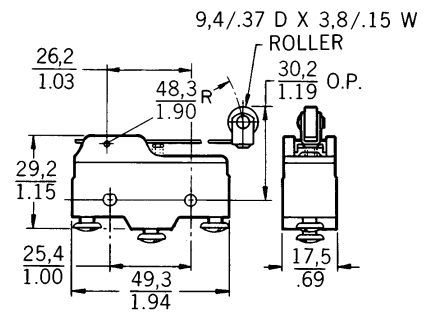

Fig. 29

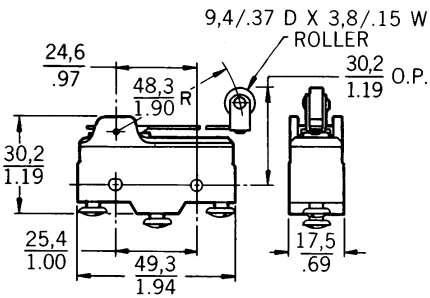

Fig. 30

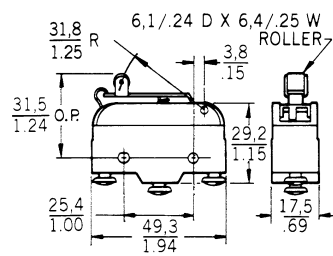
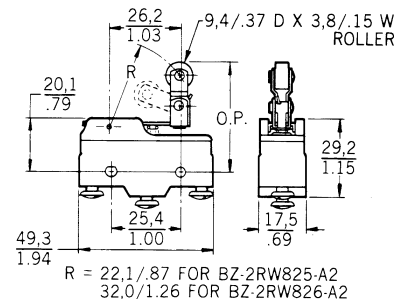

Fig. 31



R = 22,1/0.87 FOR BZ-2RW825-A2  
32,0/1.26 FOR BZ-2RW826-A2

Fig. 32

Standard  
Basic Switches

### FLEXIBLE ROLLER LEAF

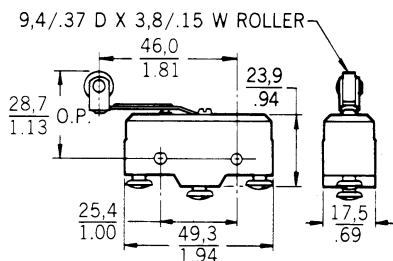

Fig. 35

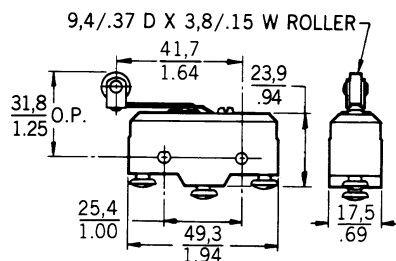

Fig. 36

Mounting holes accept pins or screws of .139" (3.53 mm) diameter.

Key:  $\frac{0,0}{0.00} = \text{mm}$   
 $\frac{0.00}{0.00} = \text{inches}$