





# 2-LINE CHIP STYLE COMMON MODE CHOKES

## ChipChoke™ CCMC Series



-  Available in 0805 (2012) and 1206 (3216) size
-  For USB2.0 and other high speed differential signal lines (IEEE1394, LVDS)
-  Suppression of common mode noise without attenuating the signal
-  Large range of common mode impedance to fit with signal frequency and noise level
-  Magnetic shield versions available for lower Rdc and higher current features



### Electrical Specifications @ 25°C

Part Number Tolerance (25%)	Common Mode Impedance @ 100MHz (Ω)	DC Resistance (Ω MAX)	Rated Voltage (Vdc)	Rated Current (mA MAX)	Withstanding Voltage (Vdc)	Insulation Resistance (MΩ MIN)
<b>0805CCMCXTH – EPOXY COATING – 0805 SIZE</b>						
PE-0805CCMC670STH	67	0.35	50	330	125	10
PE-0805CCMC900STH	90	0.40	50	300	125	10
PE-0805CCMC121STH	120	0.45	50	280	125	10
PE-0805CCMC181STH	180	0.50	50	250	125	10
<b>0805CCMCXTS – MAGNETIC SHIELD – 0805 SIZE</b>						
PE-0805CCMC670STS	67	0.25	50	400	125	10
PE-0805CCMC900STS	90	0.35	50	330	125	10
PE-0805CCMC121STS	120	0.30	50	370	125	10
PE-0805CCMC181STS	180	0.35	50	330	125	10
PE-0805CCMC261STS	260	0.40	50	300	125	10
PE-0805CCMC361STS	360	0.45	50	280	125	10
<b>1206CCMCXTS – MAGNETIC SHIELD – 1206 SIZE</b>						
PE-1206CCMC900STS	90	0.30	50	370	125	10
PE-1206CCMC161STS	160	0.40	50	340	125	10
PE-1206CCMC261STS	260	0.50	50	310	125	10
PE-1206CCMC601STS	600	0.80	50	260	125	10
PE-1206CCMC102STS	1000	1.00	50	230	125	10
PE-1206CCMC222STS	2200	1.20	50	200	125	10

**NOTE:** These part numbers are lead-free and RoHS compliant. No additional suffix or identifier is required.

### Mechanicals

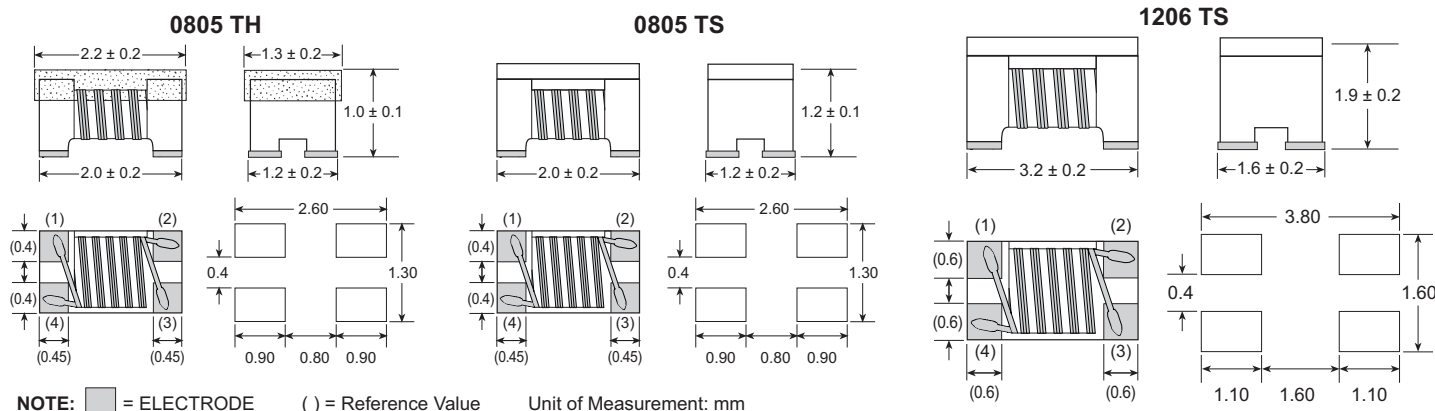

# 2-LINE CHIP STYLE COMMON MODE CHOKES

## ChipChoke™ CCMC Series



### Part Number Legend

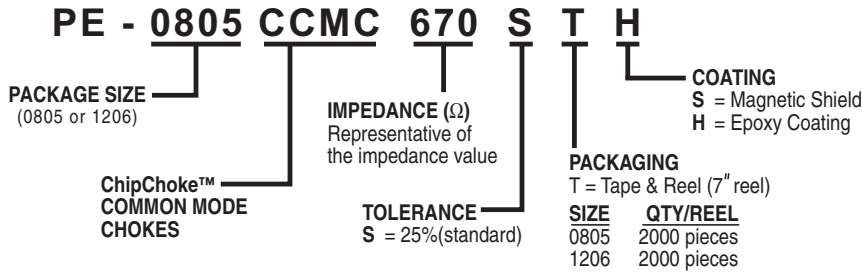

### Schematic

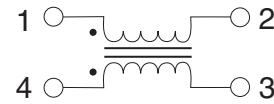

### Tape and Reel Specifications

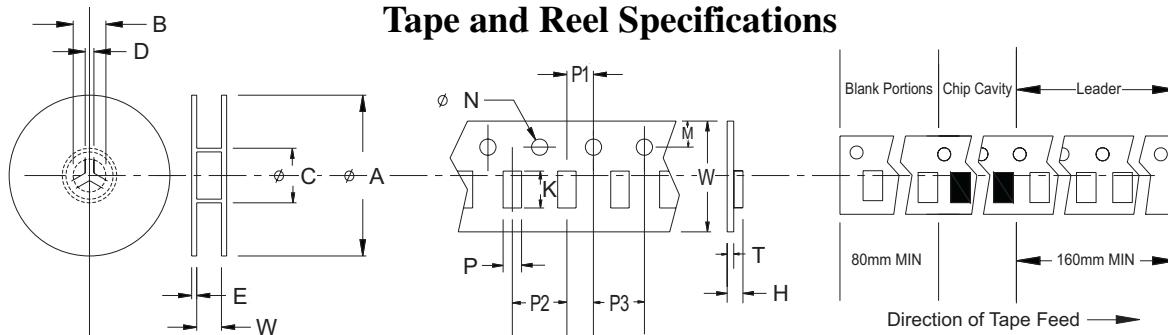

### Packaging Specifications

Series	Parts per Reel	Reel Dimensions (mm)					Tape Dimensions (mm)									
		A	B	C	D	E	W	P1	P2	P3	H	T	K	M	N	P
0805 TH	2000	178	21	75	2.0	2.5	8.0	2.0	4.0	4.0	1.08	0.3	2.33	1.75	1.5	1.48
0805 TS	2000	178	21	75	2.0	2.5	8.0	2.0	4.0	4.0	1.30	0.3	2.25	1.75	1.5	1.42
1206 TS	2000	178	21	75	2.0	2.5	8.0	2.0	4.0	4.0	2.10	0.2	3.50	1.75	1.5	1.90

### Impedance vs Frequency

#### PE-0805CCMCXXXSTH

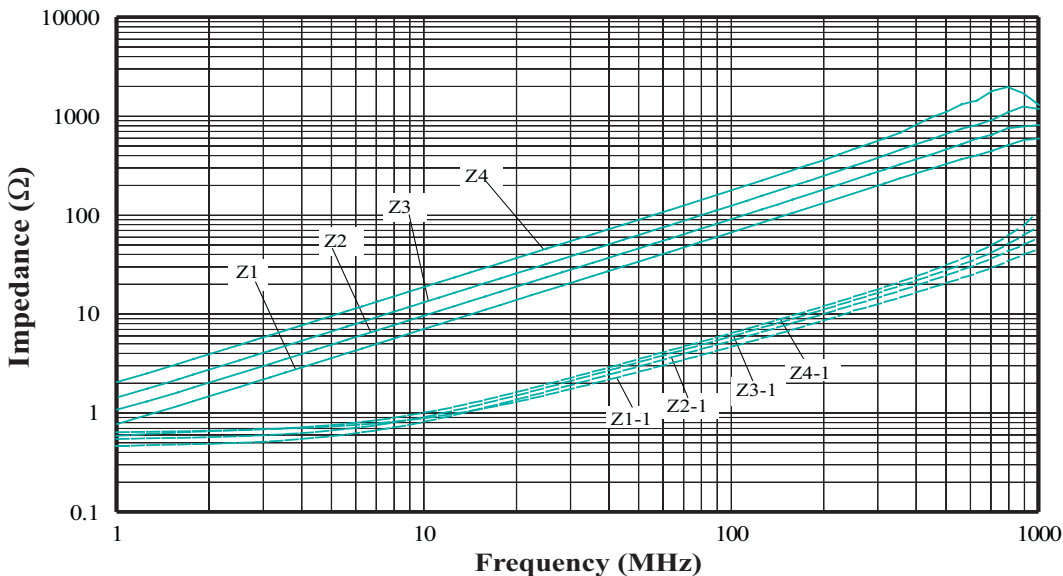

Common Mode	
ITEM	Part Number
Z1	PE-0805CCMC670STH
Z2	PE-0805CCMC900STH
Z3	PE-0805CCMC121STH
Z4	PE-0805CCMC181STH

Differential Mode	
ITEM	Part Number
Z1-1	PE-0805CCMC670STH
Z2-1	PE-0805CCMC900STH
Z3-1	PE-0805CCMC121STH
Z4-1	PE-0805CCMC181STH

# 2-LINE CHIP STYLE COMMON MODE CHOKES

## ChipChoke™ CCMC Series



### Impedance vs Frequency

#### PE-0805CCMCXXXSTS

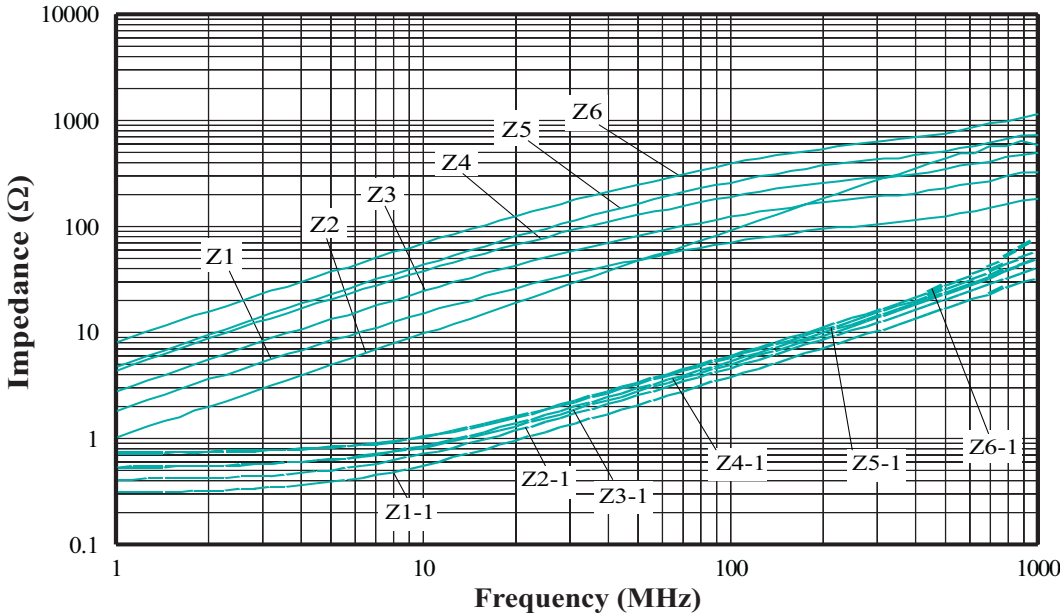

Common Mode	
ITEM	Part Number
Z1	PE-0805CCMC670STS
Z2	PE-0805CCMC900STS
Z3	PE-0805CCMC121STS
Z4	PE-0805CCMC181STS
Z5	PE-0805CCMC261STS
Z6	PE-0805CCMC361STS

Differential Mode	
ITEM	Part Number
Z1-1	PE-0805CCMC670STS
Z2-1	PE-0805CCMC900STS
Z3-1	PE-0805CCMC121STS
Z4-1	PE-0805CCMC181STS
Z5-1	PE-0805CCMC261STS
Z6-1	PE-0805CCMC361STS

#### PE-1206CCMCXXXSTS

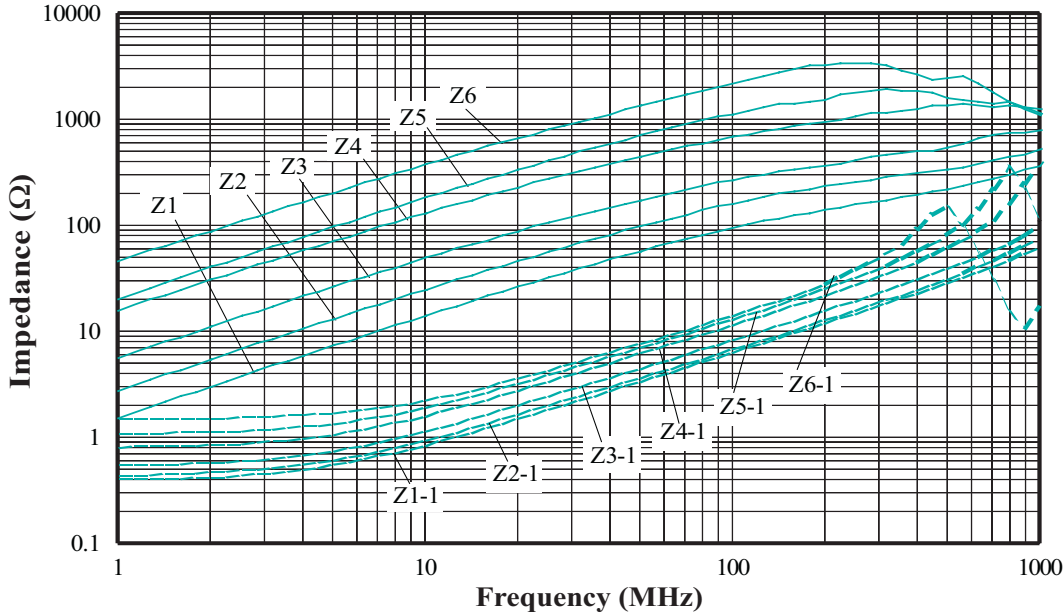

Common Mode	
ITEM	Part Number
Z1	PE-1206CCMC900STS
Z2	PE-1206CCMC161STS
Z3	PE-1206CCMC261STS
Z4	PE-1206CCMC601STS
Z5	PE-1206CCMC102STS
Z6	PE-1206CCMC222STS

Differential Mode	
ITEM	Part Number
Z1-1	PE-1206CCMC900STS
Z2-1	PE-1206CCMC161STS
Z3-1	PE-1206CCMC261STS
Z4-1	PE-1206CCMC601STS
Z5-1	PE-1206CCMC102STS
Z6-1	PE-1206CCMC222STS

### For More Information:

#### Pulse Worldwide Headquarters

12220 World Trade Drive  
San Diego, CA 92128  
U.S.A.  
[www.pulseeng.com](http://www.pulseeng.com)  
TEL: 858 674 8100  
FAX: 858 674 8262

#### Pulse Northern Europe

3 Huxley Road  
Surrey Research Park  
Guildford, Surrey GU2 5RE  
United Kingdom  
TEL: 44 1483 401700  
FAX: 44 1483 401701

#### Pulse Southern Europe

Zone Industrielle  
F-39270  
Orgelet  
France  
TEL: 33 3 84 35 04 04  
FAX: 33 3 84 25 46 41

#### Pulse China Headquarters

Room 1002  
No. 819  
Industrial District  
Changan, Dongguan  
China  
TEL: 86 769 5538070  
FAX: 86 769 5538870

#### Pulse North China

Room 1002  
No. 819  
Nanjing West Rd  
Shanghai  
China  
TEL: 86 21 32181071  
FAX: 86 21 32181396

#### Pulse South Asia

150 Kampong Ampat  
#07-01/02  
KA Centre  
Singapore 368324  
TEL: 65 6287 8998  
FAX: 65 6280 0080

#### Pulse North Asia

3F-4, No. 81, Sec. 1  
Hsin Tai Wu Road  
Hsi-Chih  
Taipei Hsien  
Taiwan  
TEL: 886 2 26980228  
FAX: 886 2 26980948

Performance warranty of products offered on this data sheet is limited to the parameters specified. Data is subject to change without notice. Other brand and product names mentioned herein may be trademarks or registered trademarks of their respective owners.

© Copyright, 2005. Pulse Engineering, Inc. All rights reserved.

[www.pulseeng.com](http://www.pulseeng.com)

W712.C (8/05)