

Magnetics for LM258X Flyback Regulator

These standard flyback regulator transformers are designed for use with National Semiconductor LM2585, LM2586, LM2587 and LM2588 **SIMPLE SWITCHER**® switching regulators.

They are available in surface mount and through hole configurations. All feature 500 V isolation between windings and a variety of available turns ratios.

Ref. number	Part number	L at 0 Adc ±15% (μ H)	L at Ipk min (μ H)	Volt-time product max (V μ sec)	Leakage Inductance ¹ max (μ H)	DCR (Ohms)		Turns ratio pri : sec	Output	Ipk ² (A)
						pri	sec			
T1 (SM)	Q4435-B	22	19.0	166.5	0.7	0.020	0.025	1 : 1	5 V, 1.6 A	4.85
T1 (PC)	Q4434-B	22	19.8	162.0	2.0	0.028	0.028	1 : 1	5 V, 1.6 A	5.0
T2 (SM)	Q4436-B	22	17.6	166.5	0.5	0.025	0.23 (10-11) 0.25 (9-8)	1 : 2.5 1 : 2.5	12 V, 0.35 A 12 V, 0.35 A	5.0
T2 (PC)	Q4337-B	22	19.8	162.0	2.0	0.030	0.32 (8-7) 0.32 (6-5)	1 : 2.5 1 : 2.5	12 V, 0.35 A 12 V, 0.35 A	5.0
T3 (PC)	Q4343-B	85	76.5	364.5	3.5	0.150	0.011 (10-9) 0.011 (7-6)	1 : 0.8 1 : 0.8	12 V, 1.4 A 12 V, 1.4 A	3.0
T4 (PC)	Q4344-B	85	76.5	364.5	3.5	0.145	0.20 (10-9) 0.20 (7-6) 0.03 (4-5)	1 : 0.8 1 : 0.8 1 : 0.35	12 V, 0.75 A 12 V, 0.75 A 5 V, 3.0 A	3.0
T5 (SM)	Q4437-B	55	47.3	299.7	2.0	0.110	0.035 (10-11) 0.30 (9-8) 0.32 (4-5)	1 : 0.5 1 : 1.167 1 : 1.167	5 V, 1.8 A 12 V, 0.25 A 12 V, 0.25 A	3.0
T5 (PC)	Q4338-B	66	59.4	499.5	3.5	0.090	0.039 (8-7) 0.58 (6-5) 0.60 (3-4)	1 : 0.5 1 : 1.167 1 : 1.167	5 V, 1.8 A 12 V, 0.25 A 12 V, 0.25 A	3.0
T6 (SM)	Q4438-B	65	57.0	299.7	3.0	0.065	0.15 (10-11) 0.15 (9-8)	1 : 1.2 1 : 1.2	12 V, 0.63 A 12 V, 0.63 A	3.0
T6 (PC)	Q4339-B	66	59.4	499.5	3.0	0.090	0.20 (8-7) 0.24 (5-6)	1 : 1.2 1 : 1.2	12 V, 0.63 A 12 V, 0.63 A	3.0
T7 (SM)	S6057-A	47	40.0	233.1	2.0	0.065	0.065	1 : 1	5 V, 0.9 A	3.0
T7 (PC)	S6000-A	47	40.0	212.6	2.0	0.065	0.042	1 : 1	5 V, 0.9 A	3.0

1. Leakage inductance measured across the primary at 0.10 Vrms, 100 kHz.
 2. DC current at which the primary inductance is measured.
 3. Operating temperature range -40° C to +85°C.
 4. Electrical specifications at 25° C.
- Refer to Doc 362 "Soldering Surface Mount Components" before soldering.

Core material Ferrite

Ambient temperature -40°C to +85°C

Storage temperature Component: -40°C to +85°C.
Packaging: -55°C to +80°C

Resistance to soldering heat (SM parts) Max three 30 second reflows at +235°C, parts cooled to room temperature between cycles

Moisture Sensitivity Level (MSL) 1 (unlimited floor life at <30°C / 85% relative humidity)

Mean Time Between Failures (MTBF) 26,315,789 hours

PCB washing Only pure water or alcohol recommended

Specifications subject to change without notice.
Please check our website for latest information.

Document 183-1 Revised 10/25/07

1102 Silver Lake Road Cary, Illinois 60013 Phone 847/639-6400 Fax 847/639-1469

E-mail info@coilcraft.com Web http://www.coilcraft.com

Magnetics for LM258X Flyback Regulator

Schematics – Surface Mount (SM)

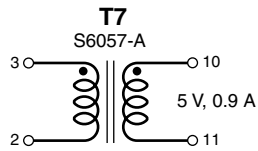
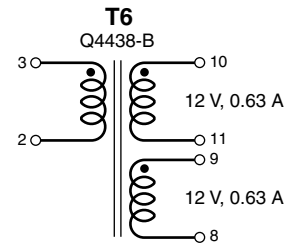
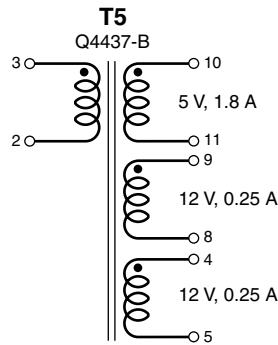
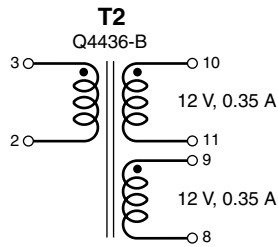
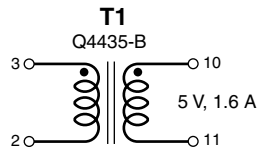

Schematics – Leaded (PC)

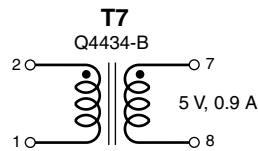
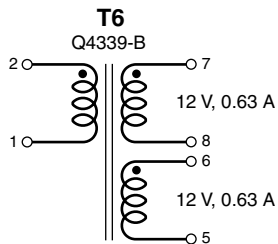
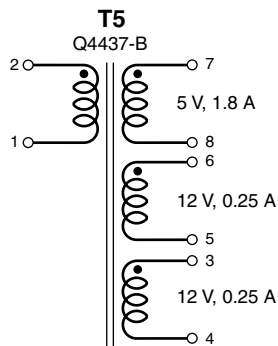
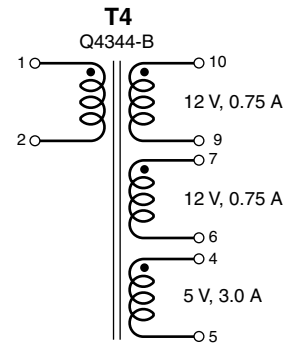
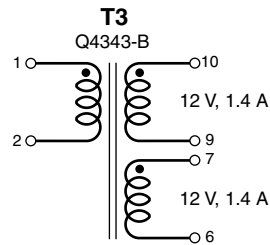
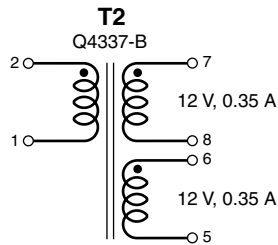
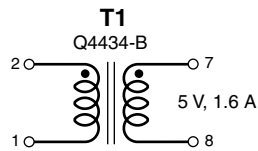

Magnetics for LM258X Flyback Regulator

Surface Mount

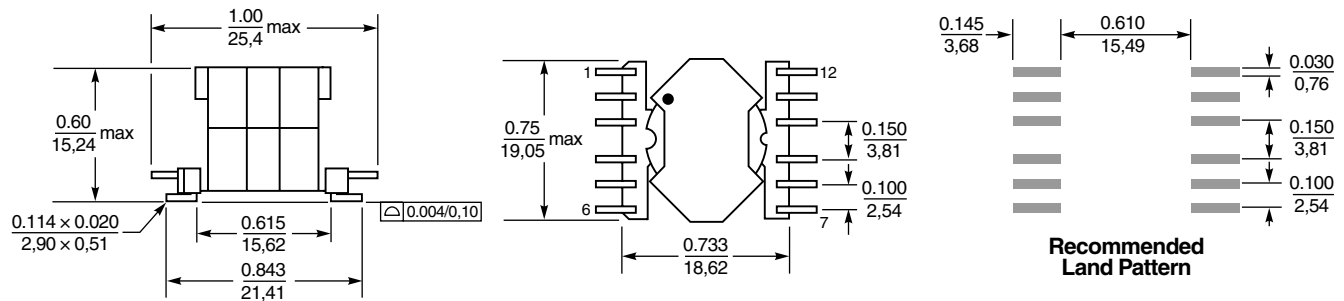

Terminations Tin-lead over tin over nickel over phos bronze.
Packaged 81 parts per tray

Leaded – T1, T2, T5, T6, T7

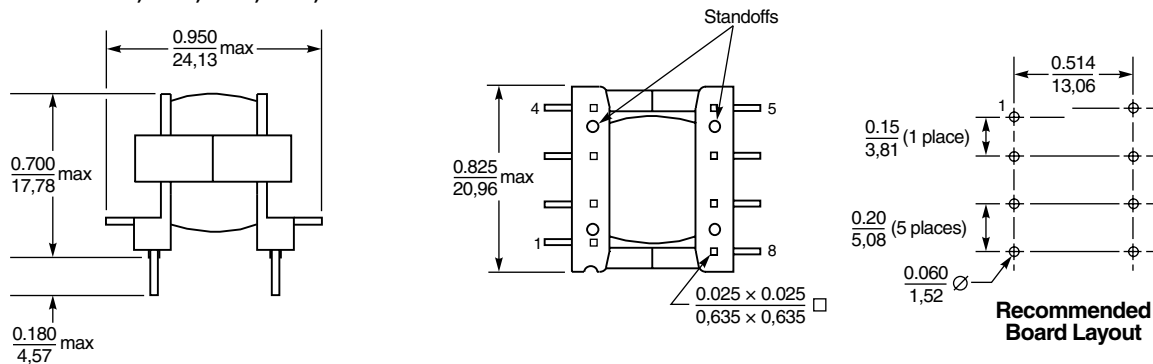

Terminations Tin-lead over tin over nickel over phos bronze.
Packaged 49 parts per tray

Leaded – T3, T4

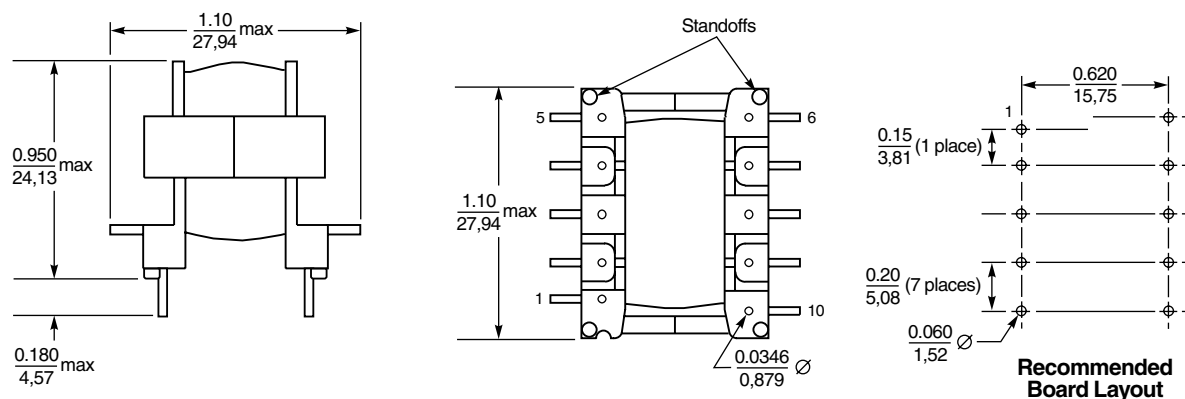

Terminations Tin-lead over tin over copper.
Packaged 30 parts per tray



Specifications subject to change without notice.
Please check our website for latest information.

Document 183-3 Revised 09/07/07

1102 Silver Lake Road Cary, Illinois 60013 Phone 847/639-6400 Fax 847/639-1469

E-mail info@coilcraft.com Web <http://www.coilcraft.com>