

LH51256L

CMOS 256K (32K × 8) Static RAM

FEATURES

- 32,768 × 8 bit organization
- Access times: 100/120 ns (MAX.)
- Power consumption:
 - Operating: 248 mW (MAX.)
(T_A = -40 to 85°C, minimum cycle)
 - Standby: 5.5 μW (MAX.)
(T_A = 0 to 60°C)
- Fully-static operation
- TTL compatible I/O
- Three-state outputs
- Single +5 V power supply
- Packages:
 - 28-pin, 600-mil DIP
 - 28-pin, 450-mil SOP

DESCRIPTION

The LH51256L is a 256K bit static RAM organized as 32,768 × 8 bits which provides low-power standby mode. It is fabricated using silicon-gate CMOS process technology.

PIN CONNECTIONS

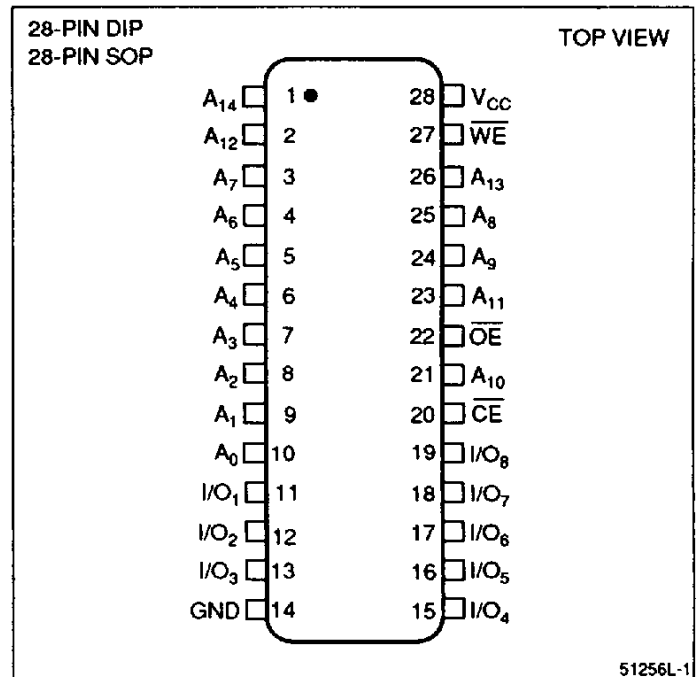

Figure 1. Pin Connections for DIP and SOP Packages

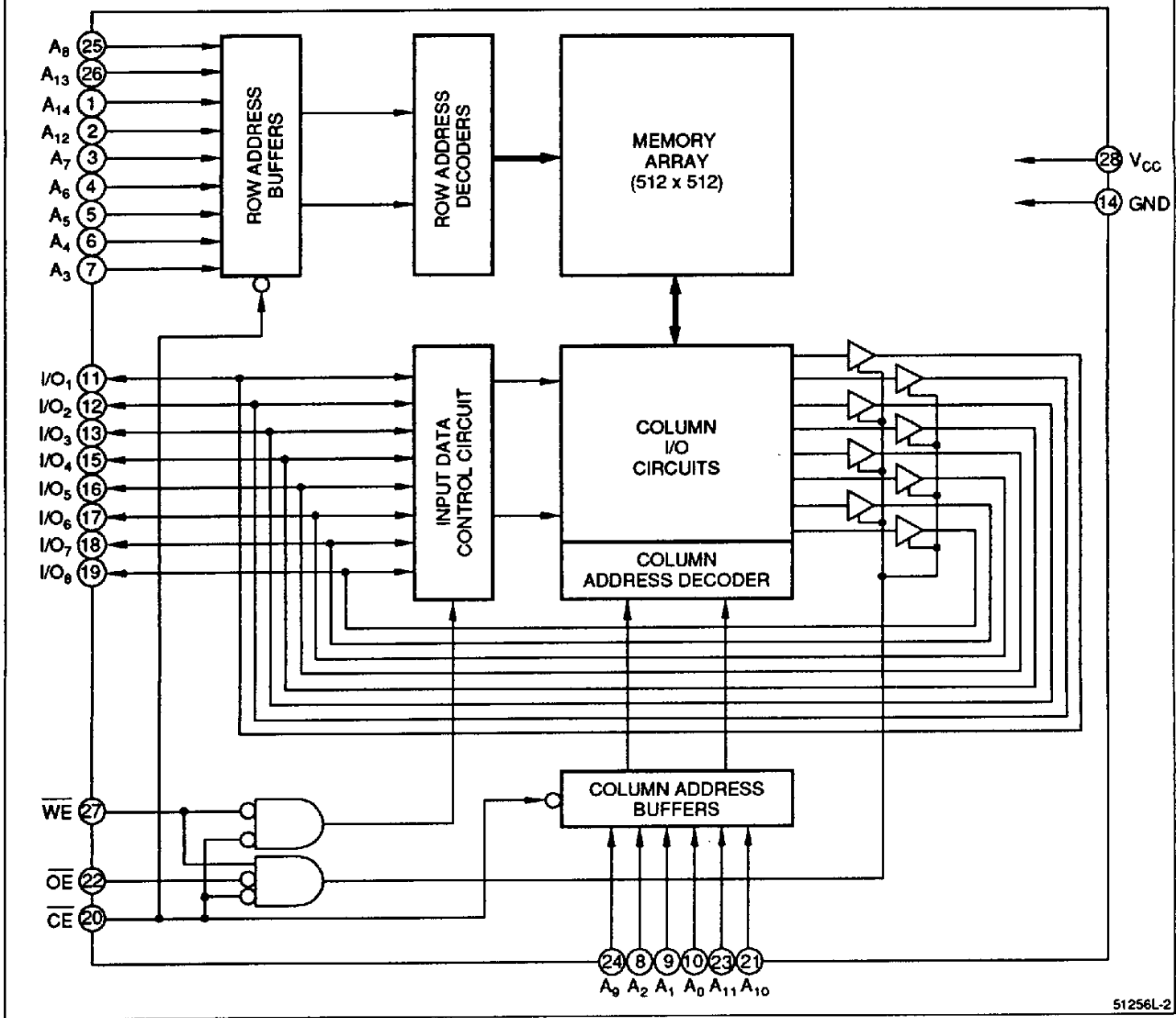

Figure 2. LH51256L Block Diagram

PIN DESCRIPTION

SIGNAL	PIN NAME
A ₀ - A ₁₄	Address input
\overline{CE}	Chip Enable input
\overline{WE}	Write Enable input
\overline{OE}	Output Enable input

SIGNAL	PIN NAME
I/O ₁ - I/O ₈	Data Input/Output
V _{cc}	Power supply
GND	Ground

TRUTH TABLE

\overline{CE}	\overline{WE}	\overline{OE}	MODE	I/O ₁ - I/O ₈	SUPPLY CURRENT	NOTE
H	X	X	Non selected	High-Z	Standby (I _{SB})	1
L	L	X	Write	D _{IN}	Operating (I _{CC})	1
L	H	L	Read	D _{OUT}	Operating (I _{CC})	
L	H	H	Output disable	High-Z	Operating (I _{CC})	

NOTE:

- X = H or L

ABSOLUTE MAXIMUM RATINGS

PARAMETER	SYMBOL	RATING	UNIT	NOTE
Supply voltage	V_{CC}	-0.3 to +7.0	V	1
Input voltage	V_{IN}	-0.3 to +7.0	V	1
Operating temperature	T_{opr}	-40 to +85	°C	
Storage temperature	T_{stg}	-55 to +150	°C	

NOTE:

- The maximum applicable voltage on any pin with respect to GND.

RECOMMENDED OPERATING CONDITIONS ($T_A = -40$ to $+85^\circ\text{C}$)

PARAMETER	SYMBOL	MIN.	TYP.	MAX.	UNIT
Supply voltage	V_{CC}	4.5	5.0	5.5	V
Input voltage	V_{IH}	2.2		$V_{CC} + 0.3$	V
	V_{IL}	-0.3		0.8	V

DC CHARACTERISTICS ($V_{CC} = 5\text{ V} \pm 10\%$, $T_A = -40$ to $+85^\circ\text{C}$)

PARAMETER	SYMBOL	CONDITIONS	MIN.	TYP.	MAX.	UNIT
Input leakage current	$ I_{LI} $	$V_{CC} = 5.5\text{ V}$ $V_{IN} = 0$ to V_{CC}			1	μA
Output leakage current	$ I_{LO} $	\overline{CE} or $\overline{OE} = V_{IH}$, $V_{IO} = 0$ to V_{CC}			1	μA
Operating current	I_{CC}	$\overline{CE} = V_{IL}$, Outputs open			45	mA
Standby current	I_{SB1}	$\overline{CE} = V_{IH}$			10	mA
	I_{SB}	$\overline{CE} \geq V_{CC} - 0.2\text{ V}$ $T_A = 0$ to $+60^\circ\text{C}$			1	μA
		$\overline{CE} \geq V_{CC} - 0.2\text{ V}$ $T_A = -40$ to $+85^\circ\text{C}$			5	μA
Output voltage	V_{OL}	$I_{OL} = 2.1\text{ mA}$			0.4	V
	V_{OH}	$I_{OH} = -1.0\text{ mA}$	2.4			V

AC CHARACTERISTICS

(1) READ CYCLE ($V_{CC} = 5\text{ V} \pm 10\%$, $T_A = -40$ to $+85^\circ\text{C}$)

PARAMETER	SYMBOL	LH51256/N-10L		LH51256/N-12L		UNIT	NOTE
		MIN.	MAX.	MIN.	MAX.		
Read cycle time	t_{RC}	100		120		ns	
Address access time	t_{AA}		100		120	ns	
Chip enable access time	t_{ACE}		100		120	ns	
Output enable access time	t_{OE}		50		60	ns	
Output hold time	t_{OH}	5		5		ns	
\overline{CE} Low to output in Low-Z	t_{LZ}	5		5		ns	1
\overline{OE} Low to output in Low-Z	t_{OLZ}	5		5		ns	1
\overline{CE} High to output in High-Z	t_{HZ}	0	30	0	30	ns	1
\overline{OE} High to output in High-Z	t_{OHZ}	0	30	0	30	ns	1

(2) WRITE CYCLE ($V_{CC} = 5 V \pm 10\%$, $T_A = -40$ to $+85^\circ C$)

PARAMETER	SYMBOL	LH51256/N-10L		LH51256/N-12L		UNIT	NOTE
		MIN.	MAX.	MIN.	MAX.		
Write cycle time	t _{wc}	100		120		ns	
\overline{CE} Low to end of write	t _{cw}	90		100		ns	
Address valid to end of write	t _{aw}	90		100		ns	
Address setup time	t _{as}	5		5		ns	
Write recovery time	t _{wr}	15		15		ns	
Write pulse width	t _{wp}	50		50		ns	
Input data setup time	t _{dw}	30		30		ns	
Input data hold time	t _{dH}	10		10		ns	
\overline{WE} High to output in High-Z	t _{ow}	0		0		ns	1
\overline{WE} Low to output in High-Z	t _{wz}	0	30	0	30	ns	1
\overline{OE} High to output in High-Z	t _{ohz}	0	30	0	30	ns	1

NOTE:
 1. Active output to high-impedance and high-impedance to output active tests specified for a ± 500 mV transition from steady state levels into the test load. $C_{LOAD} = 5$ pF.

AC TEST CONDITIONS

PARAMETER	MODE
Input voltage amplitude	0.6 V to 2.4 V
Input rise/fall time	10 ns
Timing reference level	1.5 V
Output load conditions	1TTL + $C_L = 100$ pF (Includes scope and jig capacitance)

CAPACITANCE¹ ($T_A = 25^\circ C$, $f = 1$ MHz)

PARAMETER	SYMBOL	CONDITIONS	MIN.	TYP.	MAX.	UNIT
Input capacitance	C_{IN}	$V_{IN} = 0$ V			7	pF
Input/output capacitance	$C_{I/O}$	$V_{I/O} = 0$ V			10	pF

NOTE:
 1. This parameter is sampled and not production tested.

DATA RETENTION CHARACTERISTICS ($T_A = -40$ TO $+85^\circ C$)

PARAMETER	SYMBOL	CONDITIONS	MIN.	TYP.	MAX.	UNIT	NOTE
Data retention voltage	V_{CCDR}	$\overline{CE} \geq V_{CCDR} - 0.2$ V	2.0			V	
Data retention current	I_{CCDR}	$V_{CCDR} = 3.0$ V, $\overline{CE} \geq V_{CCDR} - 0.2$ V, $T_A = 0$ to $+60^\circ C$, $V_{IN} = 0$ to V_{CCDR}			0.6	μA	
		$V_{CCDR} = 3.0$ V, $\overline{CE} \geq V_{CCDR} - 0.2$ V, $T_A = -40$ to $+85^\circ C$, $V_{IN} = 0$ to V_{CCDR}			3.0	μA	
\overline{CE} setup time	t _{cDR}		0			ns	
\overline{CE} hold time	t _{rDR}		t _{rC}			ns	1

NOTE:
 1. t_{rC} = Read cycle time

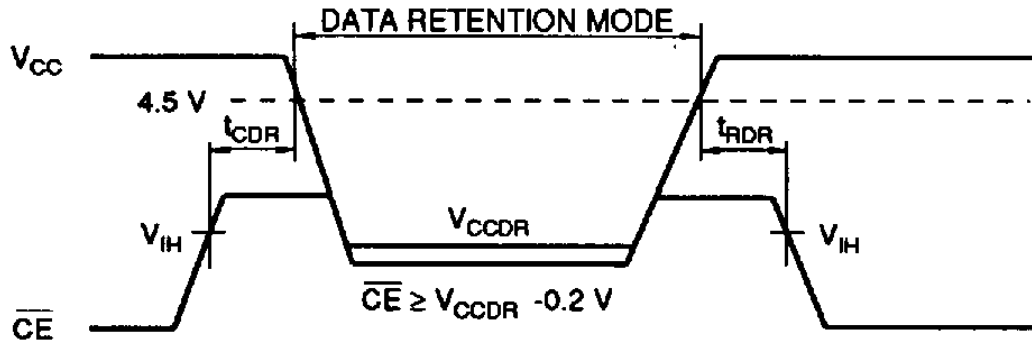
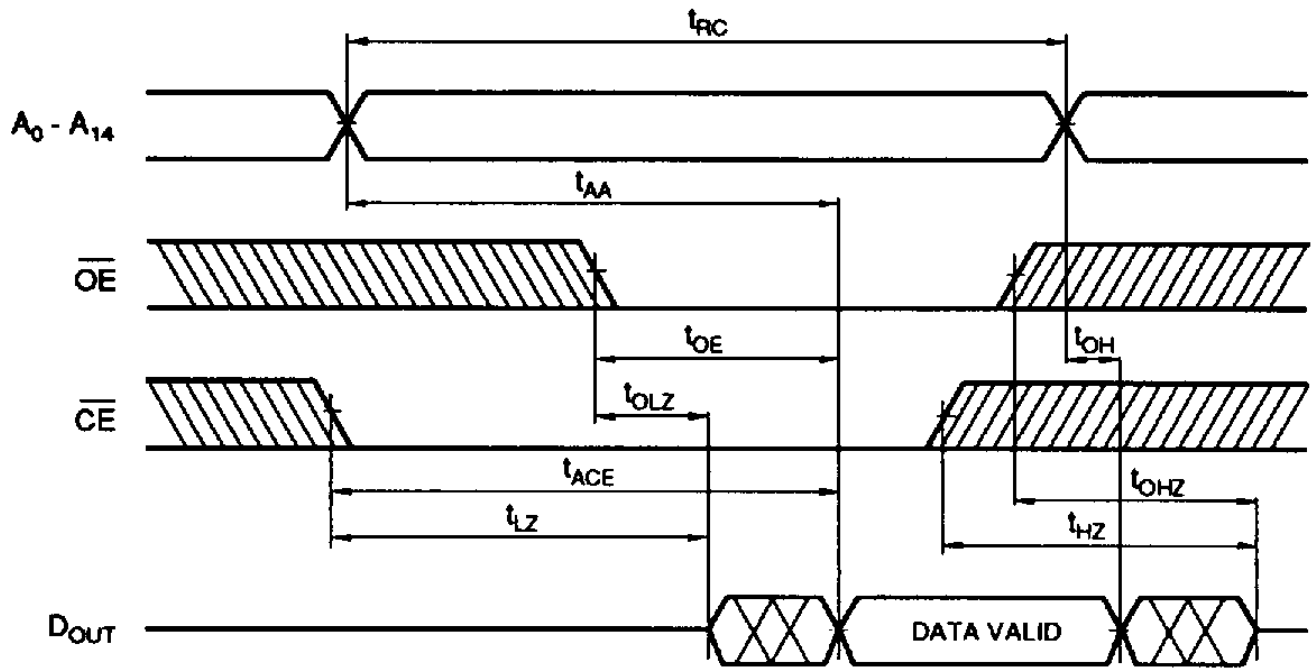
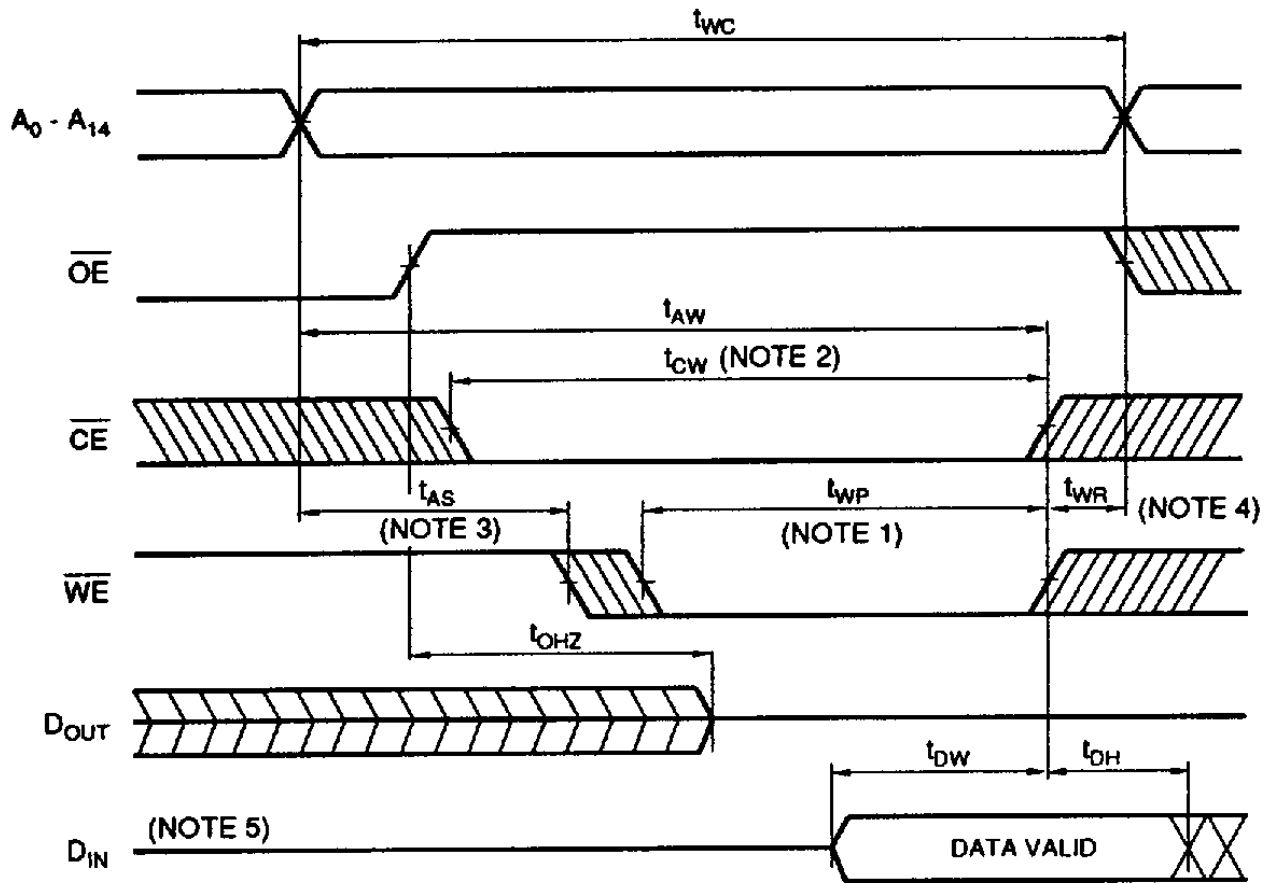

Figure 3. Data Retention Characteristics



NOTE: \overline{WE} = "HIGH"



NOTES:

1. The write pulse occurs during the overlap (t_{WP}) of $\overline{CE} = \text{LOW}$ and $\overline{WE} = \text{LOW}$.
2. t_{CW} is defined as the time from \overline{CE} LOW transition to the end of writing.
3. t_{AS} is defined as the time from address change to the start of writing.
4. t_{WR} is defined as the time from the end of writing to the address change.
5. When the I/O pins are in the output state, input signals with the opposite logic level must not be applied.

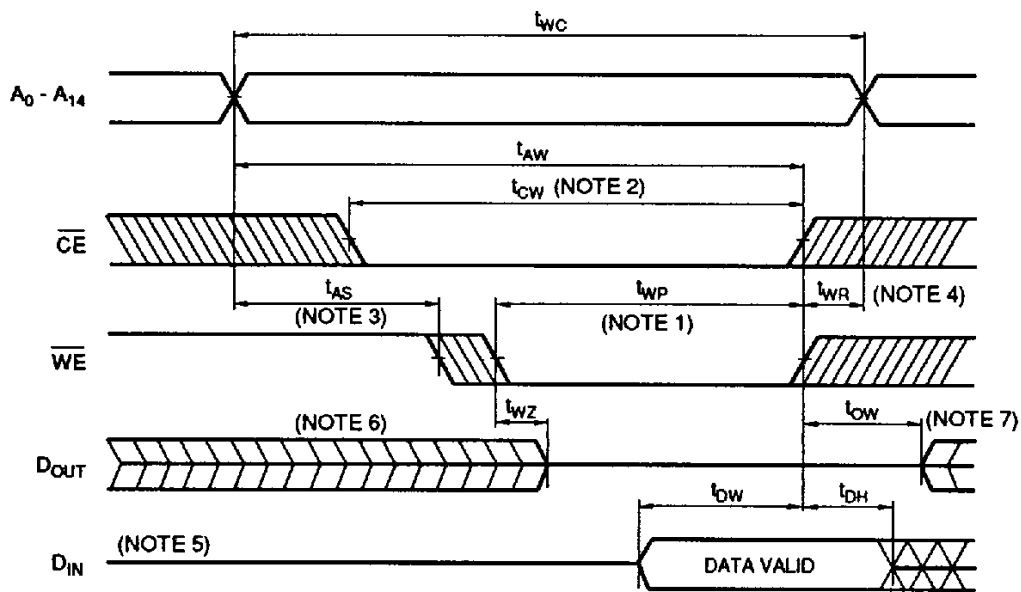

NOTES:

1. The write pulse occurs during the overlap (t_{WP}) of $\overline{CE} = \text{LOW}$ and $\overline{WE} = \text{LOW}$.
2. t_{CW} is defined as the time from CE LOW transition to the end of writing.
3. t_{AS} is defined as the time from address change to the start of writing.
4. t_{WR} is defined as the time from the end of writing to the address change.
5. When the I/O pins are in the output state, input signals with the opposite logic level must not be applied.
6. If CE LOW transition occurs at the same time or after WE LOW transition, the output will remain high-impedance.
7. If CE HIGH transition occurs at the same time or prior to the WE HIGH transition, the output will remain high-impedance.

51256L-5

Figure 6. Write Cycle 2 (\overline{OE} Low)

ORDERING INFORMATION

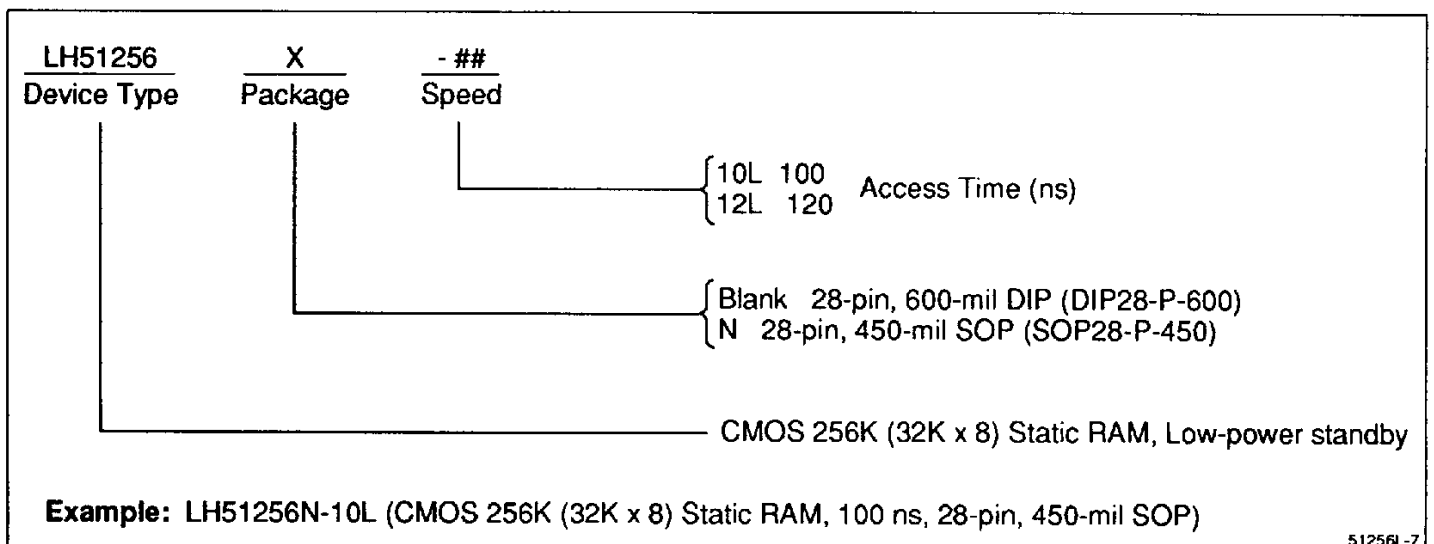

51256L-7