

**dsPICDEM™ MCHV
Development System
User's Guide**

Note the following details of the code protection feature on Microchip devices:

- Microchip products meet the specification contained in their particular Microchip Data Sheet.
- Microchip believes that its family of products is one of the most secure families of its kind on the market today, when used in the intended manner and under normal conditions.
- There are dishonest and possibly illegal methods used to breach the code protection feature. All of these methods, to our knowledge, require using the Microchip products in a manner outside the operating specifications contained in Microchip's Data Sheets. Most likely, the person doing so is engaged in theft of intellectual property.
- Microchip is willing to work with the customer who is concerned about the integrity of their code.
- Neither Microchip nor any other semiconductor manufacturer can guarantee the security of their code. Code protection does not mean that we are guaranteeing the product as "unbreakable."

Code protection is constantly evolving. We at Microchip are committed to continuously improving the code protection features of our products. Attempts to break Microchip's code protection feature may be a violation of the Digital Millennium Copyright Act. If such acts allow unauthorized access to your software or other copyrighted work, you may have a right to sue for relief under that Act.

Information contained in this publication regarding device applications and the like is provided only for your convenience and may be superseded by updates. It is your responsibility to ensure that your application meets with your specifications. MICROCHIP MAKES NO REPRESENTATIONS OR WARRANTIES OF ANY KIND WHETHER EXPRESS OR IMPLIED, WRITTEN OR ORAL, STATUTORY OR OTHERWISE, RELATED TO THE INFORMATION, INCLUDING BUT NOT LIMITED TO ITS CONDITION, QUALITY, PERFORMANCE, MERCHANTABILITY OR FITNESS FOR PURPOSE. Microchip disclaims all liability arising from this information and its use. Use of Microchip devices in life support and/or safety applications is entirely at the buyer's risk, and the buyer agrees to defend, indemnify and hold harmless Microchip from any and all damages, claims, suits, or expenses resulting from such use. No licenses are conveyed, implicitly or otherwise, under any Microchip intellectual property rights.

Trademarks

The Microchip name and logo, the Microchip logo, dsPIC, KEELOQ, KEELOQ logo, MPLAB, PIC, PICmicro, PICSTART, rPIC and UNI/O are registered trademarks of Microchip Technology Incorporated in the U.S.A. and other countries.

FilterLab, Hampshire, HI-TECH C, Linear Active Thermistor, MXDEV, MXLAB, SEEVAL and The Embedded Control Solutions Company are registered trademarks of Microchip Technology Incorporated in the U.S.A.

Analog-for-the-Digital Age, Application Maestro, CodeGuard, dsPICDEM, dsPICDEM.net, dsPICworks, dsSPEAK, ECAN, ECONOMONITOR, FanSense, HI-TIDE, In-Circuit Serial Programming, ICSP, ICEPIC, Mindi, MiWi, MPASM, MPLAB Certified logo, MPLIB, MPLINK, mTouch, nanoWatt XLP, Omniscient Code Generation, PICC, PICC-18, PICKit, PICDEM, PICDEM.net, PICTail, PIC³² logo, REAL ICE, rLAB, Select Mode, Total Endurance, TSHARC, WiperLock and ZENA are trademarks of Microchip Technology Incorporated in the U.S.A. and other countries.

SQTP is a service mark of Microchip Technology Incorporated in the U.S.A.

All other trademarks mentioned herein are property of their respective companies.

© 2009, Microchip Technology Incorporated, Printed in the U.S.A., All Rights Reserved.

 Printed on recycled paper.

QUALITY MANAGEMENT SYSTEM
CERTIFIED BY DNV
== ISO/TS 16949:2002 ==

Microchip received ISO/TS-16949:2002 certification for its worldwide headquarters, design and wafer fabrication facilities in Chandler and Tempe, Arizona; Gresham, Oregon and design centers in California and India. The Company's quality system processes and procedures are for its PIC® MCUs and dsPIC® DSCs, KEELOQ® code hopping devices, Serial EEPROMs, microperipherals, nonvolatile memory and analog products. In addition, Microchip's quality system for the design and manufacture of development systems is ISO 9001:2000 certified.

Safety Notice

The safety notices and operating instructions provided should be adhered to, to avoid a safety hazard. If in any doubt, consult your supplier.

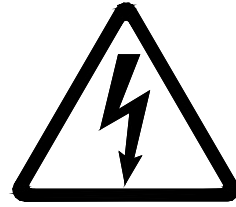

WARNING – This system must be earthed (grounded) at all times.

CAUTION – The system should not be installed, operated, serviced or modified except by qualified personnel who understand the danger of electric shock hazards and have read and understood the user instructions. Any service or modification performed by the user is done at the user's own risk and voids all warranties.

WARNING – The output terminals are NOT isolated from the incoming AC mains supply and may be at up to 410V with respect to ground, regardless of the input mains supply voltage applied. These terminals are live during operation AND for five minutes after disconnection from the supply. Do not attempt to access the terminals or remove the cover during this time.

WARNING – The unit may obtain power through the output terminals if these are connected to a rotating motor acting as a generator. If this is the case, then the previous warning also applies (i.e., the output terminals are live when connected to the generator and for five minutes after the generator has been stopped). Note that this case can arise even when the unit has been disconnected from the incoming AC mains supply.

CAUTION – If a motor is connected to the output of this unit, the frame should be connected to the output protective ground terminal provided. Particular care should be taken to mechanically guard such a motor, bearing in mind that unexpected behavior is likely to result from the process of code development.

CAUTION – For continued protection against the risk of fire, replace the fuse with one of the same type only (i.e., Fast Act Fuse 15A/250 V).

dsPICDEM™ MCHV Development System User's Guide

- The system is intended for evaluation and development purposes and should only be operated in a normal laboratory environment as defined by IEC 61010-1:2001.
- Clean with a dry cloth only.
- Operate flat on a bench, do not move during operation and do not block the ventilation holes.
- The system should not be operated without all the supplied covers fully secured in place.
- The system should not be connected or operated if there is any apparent damage to the unit.
- The unit is designed to be connected to the AC mains supply via a standard non-locking plug. As the unit has no mains switch, this plug constitutes the means of disconnection from the supply and thus the user must have unobstructed access to this plug during operation.



dsPICDEM™ MCHV DEVELOPMENT SYSTEM USER'S GUIDE

Table of Contents

Chapter 1. Introduction	
1.1 Overview	7
Chapter 2. Getting Started	
2.1 Board Components	13
2.2 User Interface	14
2.3 Connecting the System	15
2.4 Power Sequences	19
Chapter 3. Running the Demonstration	
Chapter 4. Hardware	
4.1 Power Factor Correction (PFC) Stage Board	29
4.2 Power Module Stage	33
4.3 Electrical Specifications	43
Appendix A. Board Layout and Schematics	

dsPICDEM™ MCHV Development System User's Guide

NOTES:



dsPICDEM™ MCHV DEVELOPMENT SYSTEM USER'S GUIDE

Preface

NOTICE TO CUSTOMERS

All documentation becomes dated, and this manual is no exception. Microchip tools and documentation are constantly evolving to meet customer needs, so some actual dialogs and/or tool descriptions may differ from those in this document. Please refer to our web site (www.microchip.com) to obtain the latest documentation available.

Documents are identified with a “DS” number. This number is located on the bottom of each page, in front of the page number. The numbering convention for the DS number is “DSXXXXA”, where “XXXX” is the document number and “A” is the revision level of the document.

For the most up-to-date information on development tools, see the MPLAB® IDE on-line help. Select the Help menu, and then Topics to open a list of available on-line help files.

INTRODUCTION

This preface contains general information that will be useful to know before using the dsPICDEM™ Motor Control High-Voltage (MCHV) Development System. Topics discussed in this preface include:

- Document Layout
- Conventions Used in this Guide
- Warranty Registration
- Recommended Reading
- The Microchip Web Site
- Development Systems Customer Change Notification Service
- Customer Support
- Document Revision History

DOCUMENT LAYOUT

This user's guide describes how to use the dsPICDEM™ MCHV Development System. The document is organized as follows:

- **Chapter 1. “Introduction”** – This chapter introduces the dsPICDEM™ MCHV Development System and provides a brief overview of its features.
- **Chapter 2. “Getting Started”** – This chapter provides information on getting started with the dsPICDEM™ MCHV Development System.
- **Chapter 3. “Running the Demonstration”** – This chapter describes the demonstration software that is preloaded on the dsPIC33F device that accompanies the dsPICDEM™ MCHV Development System.
- **Chapter 4. “Hardware”** – This chapter describes the hardware on the dsPICDEM™ MCHV Development System.
- **Appendix A. “Board Layout and Schematics”** – This appendix provides diagrams of the hardware layout, as well as schematic diagrams for the dsPICDEM™ MCHV Development System.

dsPICDEM™ MCHV Development System User's Guide

CONVENTIONS USED IN THIS GUIDE

This manual uses the following documentation conventions:

DOCUMENTATION CONVENTIONS

Description	Represents	Examples
Arial font:		
Italic characters	Referenced books	<i>MPLAB® IDE User's Guide</i>
	Emphasized text	...is the <i>only</i> compiler...
Initial caps	A window	the Output window
	A dialog	the Settings dialog
	A menu selection	select Enable Programmer
Quotes	A field name in a window or dialog	"Save project before build"
Underlined, italic text with right angle bracket	A menu path	<u><i>File>Save</i></u>
Bold characters	A dialog button	Click OK
	A tab	Click the Power tab
N'Rnnnn	A number in verilog format, where N is the total number of digits, R is the radix and n is a digit.	4'b0010, 2'hF1
Text in angle brackets < >	A key on the keyboard	Press <Enter>, <F1>
Courier New font:		
Plain Courier New	Sample source code	#define START
	Filenames	autoexec.bat
	File paths	c:\mcc18\h
	Keywords	_asm, _endasm, static
	Command-line options	-Opa+, -Opa-
	Bit values	0, 1
	Constants	0xFF, 'A'
Italic Courier New	A variable argument	<i>file.o</i> , where <i>file</i> can be any valid filename
Square brackets []	Optional arguments	mcc18 [options] <i>file</i> [options]
Curly braces and pipe character: { }	Choice of mutually exclusive arguments; an OR selection	errorlevel {0 1}
Ellipses...	Replaces repeated text	var_name [, var_name...]
	Represents code supplied by user	void main (void) { ... }

WARRANTY REGISTRATION

Please complete the enclosed Warranty Registration Card and mail it promptly. Sending in the Warranty Registration Card entitles users to receive new product updates. Interim software releases are available at the Microchip web site.

RECOMMENDED READING

This user's guide describes how to use the dsPICDEM™ MCHV Development System. The device-specific data sheets contain current information on programming the specific microcontroller or digital signal controller devices. Other useful documents are listed below. The following Microchip documents are available and recommended as supplemental reference resources:

MPLAB® IDE Simulator, Editor User's Guide (DS51025)

This user's guide is a comprehensive guide that describes installation and features of Microchip's MPLAB Integrated Development Environment (IDE), as well as the editor and simulator functions in the MPLAB IDE environment.

Readme Files

For the latest information on using other tools, read the tool-specific Readme files in the Readme subdirectory of the MPLAB IDE installation directory. The Readme files contain updated information and known issues that may not be included in this user's guide.

MPASM™ Assembler, MPLINK™ Object Linker, MPLIB™ Object Librarian User's Guide (DS33014)

This user's guide describes how to use the Microchip MPASM Assembler, the MPLINK Object Linker and the MPLIB Object Librarian.

dsPIC33FJ12MC202 PIM Information Sheet (DS70314)

This document provides device specific information for the dsPIC33FJ12MC202 PIM device. The dsPIC33FJ12MC202 is a high-performance 16-bit digital signal controller within a small 28-pin 6x6 mm QFN package.

dsPIC33FJ32MC204 PIM Information Sheet (DS70316)

This document provides device specific information for the dsPIC33FJ32MC204 PIM device. The dsPIC33FJ32MC204 is a high-performance 16-bit digital signal controller within a small 44-pin QFN package.

dsPIC33FJ128MC804 PIM Information Sheet (DS70326)

This document provides device specific information for the dsPIC33FJ128MC804 PIM device. The dsPIC33FJ128MC804 is a high-performance 16-bit digital signal controller within a small 44-pin QFN package.

dsPIC33FJ256MC710 PIM Information Sheet (DS70564)

This document provides device specific information for the dsPIC33FJ256MC710 PIM device. The dsPIC33FJ256MC710 is a high-performance 16-bit digital signal controller within a 100-pin TQFP package.

dsPIC33FJ12MC201/202 Data Sheet (DS70265)

This data sheet contains device specific information for the dsPIC33FJ12MC201/202 Digital Signal Controller (DSC) Devices. The dsPIC33F devices contain extensive Digital Signal Processor (DSP) functionality with a high performance 16-bit microcontroller (MCU) architecture.

dsPIC33FJ32MC202/204 and dsPIC33FJ16MC304 Data Sheet (DS70283)

This data sheet provides device specific information for the dsPIC33FJ32MC202/204 and dsPIC33FJ16MC304 motor control family of devices.

dsPICDEM™ MCHV Development System User's Guide

dsPIC33FJ32MC302/304, dsPIC33FJ64MCX02/X04, and dsPIC33FJ128MCX02/X04 Data Sheet (DS70291)

This data sheet contains device specific information for the dsPIC33FJ32MC302/304, dsPIC33FJ64MCX02/ X04, and dsPIC33FJ128MCX02/X04 motor control family of devices.

dsPIC33FJXXXMCX06/X08/X10 Data Sheet (DS70287)

This data sheet contains device specific information for the dsPIC33FJXXXMCX06/ X08/X10 motor control family of devices.

To obtain any of these documents, visit the Microchip web site at www.microchip.com.

THE MICROCHIP WEB SITE

Microchip provides online support via our web site at www.microchip.com. This web site is used as a means to make files and information easily available to customers. Accessible by using your favorite Internet browser, the web site contains the following information:

- **Product Support** – Data sheets and errata, application notes and sample programs, design resources, user's guides and hardware support documents, latest software releases and archived software
- **General Technical Support** – Frequently Asked Questions (FAQs), technical support requests, online discussion groups, Microchip consultant program member listing
- **Business of Microchip** – Product selector and ordering guides, latest Microchip press releases, listing of seminars and events, listings of Microchip sales offices, distributors and factory representatives

DEVELOPMENT SYSTEMS CUSTOMER CHANGE NOTIFICATION SERVICE

Microchip's customer notification service helps keep customers current on Microchip products. Subscribers will receive e-mail notification whenever there are changes, updates, revisions or errata related to a specified product family or development tool of interest.

To register, access the Microchip web site at www.microchip.com, click on Customer Change Notification and follow the registration instructions.

The Development Systems product group categories are:

- **Compilers** – The latest information on Microchip C compilers and other language tools. These include the MPLAB C18 and MPLAB C30 C compilers; MPASM™ and MPLAB ASM30 assemblers; MPLINK™ and MPLAB LINK30 object linkers; and MPLIB™ and MPLAB LIB30 object librarians.
- **Emulators** – The latest information on Microchip in-circuit emulators. This includes the MPLAB ICE 2000 and MPLAB ICE 4000.
- **In-Circuit Debuggers** – The latest information on the Microchip in-circuit debugger, MPLAB ICD 2.
- **MPLAB® IDE** – The latest information on Microchip MPLAB IDE, the Windows® Integrated Development Environment for development systems tools. This list is focused on the MPLAB IDE, MPLAB SIM simulator, MPLAB IDE Project Manager and general editing and debugging features.
- **Programmiers** – The latest information on Microchip programmers. These include the MPLAB PM3 and PRO MATE II device programmers and the PICSTART® Plus and PICKit™ 1 development programmers.

CUSTOMER SUPPORT

Users of Microchip products can receive assistance through several channels:

- Distributor or Representative
- Local Sales Office
- Field Application Engineer (FAE)
- Technical Support

Customers should contact their distributor, representative or field application engineer (FAE) for support. Local sales offices are also available to help customers. A listing of sales offices and locations is included in the back of this document.

Technical support is available through the web site at: <http://support.microchip.com>

DOCUMENT REVISION HISTORY

Revision A (June 2009)

This is the initial released revision of this document.

dsPICDEM™ MCHV Development System User's Guide

NOTES:

Chapter 1. Introduction

1.1 OVERVIEW

The Microchip dsPICDEM™ MCHV Development System is intended to aid the user in the rapid evaluation and development of a wide variety of motor control applications using a dsPIC® Digital Signal Controller (DSC). This development system is targeted to control Brushless DC (BLDC) motors, Permanent Magnet Synchronous Motors (PMSM), and AC Induction Motors (ACIM) in sensor or sensorless operation.

This flexible and cost-effective tool can be configured in different ways for use with Microchip's specialized Motor Control DSCs. The dsPICDEM™ MCHV Development System supports the dsPIC33F Motor Control device family, and offers a mounting option to connect either a 28-pin SOIC device or a generic 100-pin Plug-In Module (PIM).

The system has a three-phase power module device that contains the motor inverter and the gate driver's circuitry. The circuit drives a BLDC, PMSM, or ACIM motor using different control techniques without requiring any additional hardware. It also has Power Factor Correction (PFC) circuitry in order to provide a full set of tools used in motor control applications. Figure 1-1 provides a photograph of the dsPICDEM™ MCHV Development System. A block diagram that shows the main components of the system is provided in Figure 1-2.

The rated continuous output current from the inverter is 6.5A (RMS). This allows up to approximately 2 kVA output when running from a 208V to 230V single-phase input voltage in a maximum 30°C (85°F) ambient temperature environment. Therefore, the system is ideally suited for running a standard 3-Phase Induction Motor of up to 1.4 kW (1.8 HP) rating or a slightly higher rated industrial servo-motor. The power module is capable of driving other types of motors and electrical loads that do not exceed the maximum power limit and are predominantly inductive. Furthermore, single-phase loads can be driven using one or two of the inverter outputs.

The unit is capable of operating from 90V up to a maximum of 265V. A more detailed explanation of power limitations is provided in **Chapter 4. "Hardware"**.

Note: It is recommended to carefully read the hardware section mentioned above before attempting to use the system.

dsPICDEM™ MCHV Development System User's Guide

FIGURE 1-1: dsPICDEM™ MCHV DEVELOPMENT SYSTEM



FIGURE 1-2: SYSTEM BLOCK DIAGRAM

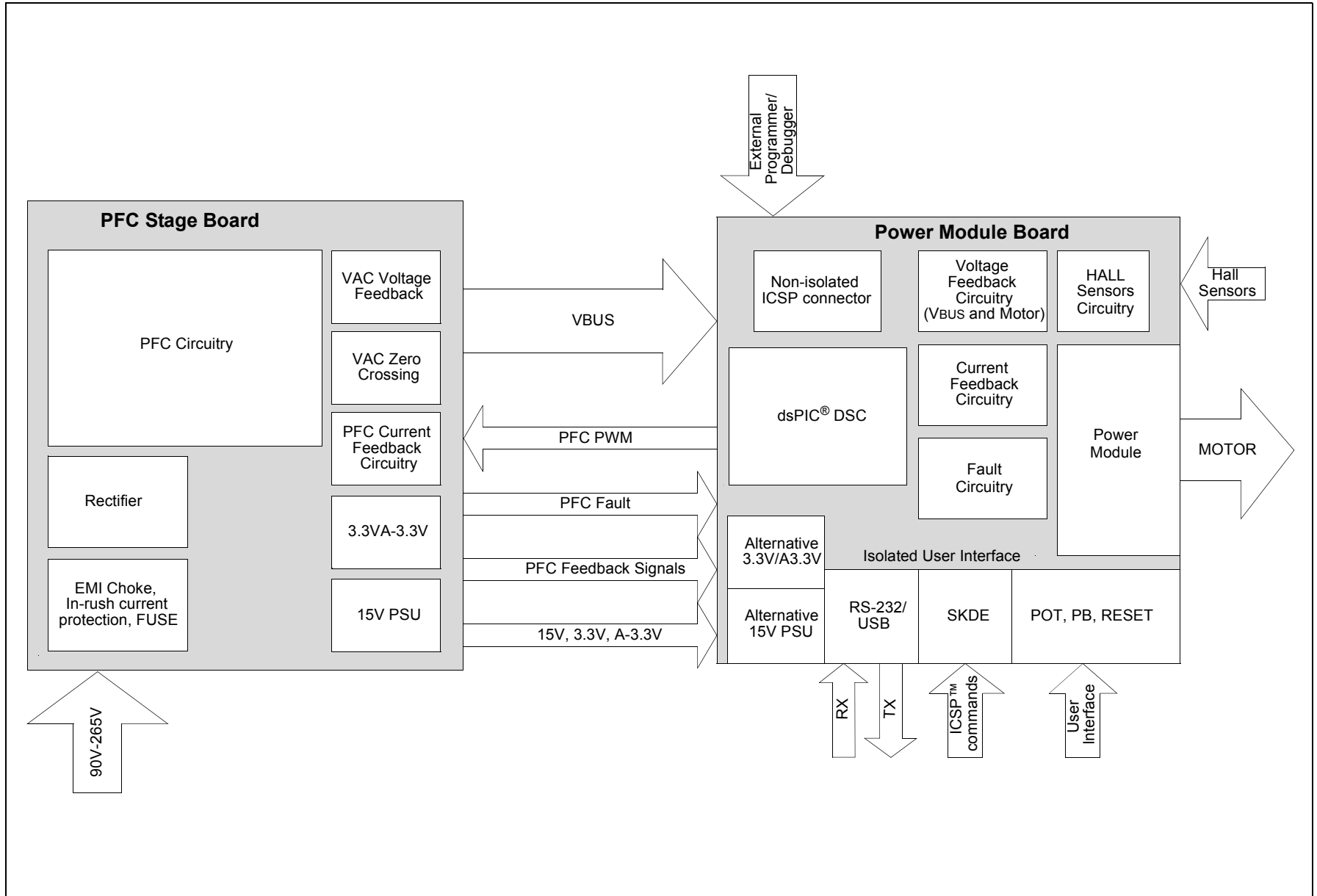

1.1.1 Features

The following are some of the key features of the dsPICDEM™ MCHV Development System.

Supported Devices:

- 28-pin to 100-pin dsPIC33FJXXXMC202 PIM (MA330014) with a dsPIC33F Motor Control device (U11) socket
- 44-pin to 100-pin dsPIC33FJXXXMCX04 PIM (MA330017 and MA330018) with a dsPIC33F Motor Control device (U11) socket
- 100-pin to 100-pin dsPIC33FJXXXMCX10 PIM (MA330013) with a dsPIC33F Motor Control device (U11) socket
- dsPIC33FJ12MC202 Motor Control device in a SOIC package (U12) footprint

Motor Control Interfaces:

- Three-phase inverter bridge with a power rating of 400V/6.5A (J17)
- Hall sensors/Quadrature Encoder Interface (QEI) for sensed motor control algorithms (J9)
- Phase voltage feedback for sensorless BLDC operation
- DC bus current sense resistor for single shunt vector control
- Phase current sense resistor for dual shunt vector control
- Overcurrent protection

Input/Output Control Switches:

- One isolated push button (S1)
- Isolated reset push button (RESET)
- Isolated 10 k Ω potentiometer (POT1)
- LED indicator for PWM outputs

Isolated Communication Ports:

- UART communication via USB (J6)
- UART communication via RS-232 (J8)

Built-In Isolated Programmer/Debugger (J20):

- Starter Kit-type programmer/debugger (daughter card)

Power Supply Connectors:

- Power Tab Fast-On connectors (BP1 and BP2) for the power stage
- Auxiliary 24V power input connector (J15) for the dsPIC DSC device and low-power circuitry (non-populated)
- Auxiliary 15V and 3.3V regulators for regulating auxiliary power supply (non-populated)

Programming Connectors:

- ICSP™ connector for programming a dsPIC DSC device (J18), non-isolated
- ICSP connector for programming the PIC18LF2450 USB module to the UART Bridge (J1), isolated
- ICSP connector for programming the Starter Kit Programmer/Debugger (SKDE), isolated PIC18F67J50 (J4)

Power Factor Corrector:

- Maximum input voltage 90 VAC-265 VAC
- Current Feedback circuitry
- VAC input voltage sensing
- Zero-crossing detection
- DC bus sensing
- Overcurrent protection (The maximum power available is specified in **Section 4.3 “Electrical Specifications”**.)

Built-In Power Supplies:

- 15V power supply, maximum power available 11W
- 3.3V power supply, maximum power available 2W

Additional Protection Circuitry:

- 250 VAC/15A fuse
- In-rush current limiter
- EMI filter

dsPICDEM™ MCHV Development System User's Guide

NOTES:

Chapter 2. Getting Started

2.1 BOARD COMPONENTS

The dsPICDEM™ MCHV Development System comprises two stages:

- PFC Stage

The first stage is integrated by the Power Factor Correction (PFC) circuitry, the full-bridge rectifier, the 15V power supply, and the 3.3V power supply.

- Power Module Stage

The second stage is the power module board. This board contains the dsPIC DSC connector, the isolated user interface connectors, and the motor drive.

Figure 2-1 shows an interior view of the system.

FIGURE 2-1: dsPICDEM™ MCHV DEVELOPMENT SYSTEM



2.2 USER INTERFACE

The dsPICDEM™ MCHV Development System has the following components to interact with the user. Figure 2-2 shows a photograph of the front of the system.

- Input/Output Control Switches (Figure 2-2):
 - One isolated push button (**S1**)
 - Isolated reset push button (**RESET**)
 - Isolated 10 kΩ potentiometer (**POT1**)
 - LED indicator for PWM outputs
- PWM Outputs (Figure 2-2)
 - Enable and disable jumpers (**J7**)
- Isolated Communication Ports (Figure 2-2):
 - UART communication via USB (**J6**)
 - UART communication via RS-232 (**J8**)
 - Communication Ports Selector (**J2, J3**)
- Built-In Isolated Programmer/Debugger (Figure 2-2)
 - Starter Kit type programmer/debugger (**J20**)
- Motor Connectors (Figure 2-3):
 - Three-phase inverter bridge connector with a power rating of 400V/6.5A (**J17**)
 - Hall sensors/Quadrature encoder interface for sensed motor control algorithms (**J9**)
- Power Supply Connector (Figure 2-4)
 - AC power inlet specified for 40VAC-220VAC 10Amps max (**J1**)

FIGURE 2-2: dsPICDEM™ MCHV DEVELOPMENT SYSTEM (FRONT)



FIGURE 2-3: dsPICDEM™ MCHV DEVELOPMENT SYSTEM (LEFT SIDE)

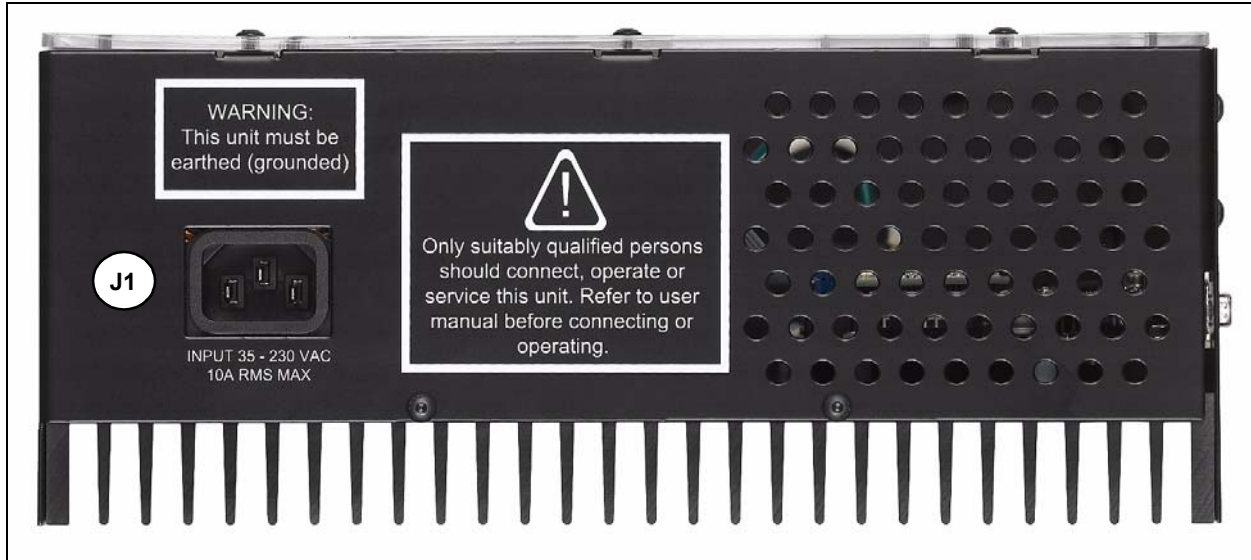

FIGURE 2-4: dsPICDEM™ MCHV DEVELOPMENT SYSTEM (RIGHT SIDE)



2.3 CONNECTING THE SYSTEM

CAUTION

The user must be aware of the operating procedures outlined below and ensure that they are followed. Failure to do so may result in damage to the system.

2.3.1 Power Connections

It is recommended that cables used for the power connections should be terminated with blue or red insulated crimp terminals. If crimp terminals are not used, care should be taken to ensure that stray strands of wire do not short to adjacent terminals or the enclosure. If possible, all wires should be stripped and tinned with solder before connecting to the dsPICDEM™ MCHV Development System terminals.

dsPICDEM™ MCHV Development System User's Guide

For the AC mains supply input, standard double-insulated, 3-core flex cable should be used with a minimum current rating of 10A (1 mm² 18 AWG). A computer power cable can be used.

Note: The system is designed for installation category II. Therefore, the incoming mains cable should be wired into a standard non-locking 2-pin in addition with a earth ground type plug.

The recommended output cable size is 1.0 to 1.5 mm² (18-16 AWG) and it should have a 600V rating. This cable should also be double insulated or have a protective ground screen. Access to the terminal screws is provided via holes in the lid of the enclosure. A slotted screwdriver should be used.

Note: The user should only access the power terminals when the system is fully discharged (see the “**Safety Notice**” on page iii).

Figure 2-6 provides the locations of all connectors. Corresponding tables that describe each connection are provided in the relevant section.

FIGURE 2-5: dsPICDEM™ MCHV DEVELOPMENT SYSTEM CONNECTIONS



The power connections are listed in Table 2-1.

TABLE 2-1: POWER CONNECTIONS

Number	Name	Type
1	Neutral	Input
2	Earth Ground	Input
3	Live (Fused)	Input
4	Motor Phase 1 (M1)	Output
5	Motor Phase 2 (M2)	Output
6	Motor Phase 3 (M3)	Output
7	Hall Sensor A (HA)	Input
8	Hall Sensor B (HB)	Input
9	Hall Sensor C (HC)	Input
10	Hall Sensors, 5V power supply terminal	Output
11	Hall Sensors, Ground terminal	Output

2.3.2 Host/Communication Connections

A mini-USB-to-USB certified cable and a standard DB9 male-to-female cable should be used to connect the dsPICDEM™ MCHV Development System to the host computer.

The communication port connectors are listed in Table 2-2. Refer to Figure 2-5 for their exact location.

TABLE 2-2: COMMUNICATION PORT CONNECTORS

Number	Name	Type
12	USB-to-UART connector	Input/Output
13	RS-232 to-UART connector	Input/Output
14	USB connector for the Starter Kit programmer/debugger	Input/Output
15	Non-isolated ICSP™ connector for device programming/debugging	Input/Output

2.3.2.1 CONNECTION SEQUENCE

The recommended connection sequence is listed below. The user should ensure that the following sequence is met before connecting the system to the mains, a motor and a host computer.

Note: Before making any connection, verify that the system is not powered and it is fully discharged. The system is completely discharged when the red LED D13 is OFF.

1. Connect the motor terminals R, Y, and B (also known as RWB or 123 or ABC) to the connection nodes M1, M2, and M3 (4, 5, and 6 in Figure 2-5), respectively.
2. Follow the next steps if position sensors are utilized to control the motor. If not, proceed to step 3.
 - a) If the motor position is sensed with Hall Sensors, connect the terminals A, B, and C to the connection nodes HA, HB, and HC (7, 8, and 9 in Figure 2-5), respectively. Also, connect the positive terminal +5V to the connection node +5V and the ground terminal to the connection node GND (10 and 11 in Figure 2-5).
 - b) If the motor position is sensed with a Quadrature Encoder, connect the terminals phase A, phase B, and Index to the connection nodes HA, HB, and HC (7, 8, and 9 in Figure 2-5), respectively.

dsPICDEM™ MCHV Development System User's Guide

3. Connect the communication ports.
 - a) If R-S32 communication is used, connect the DB9 male connector to the RS-232 port. Connect the other end to the host PC (12 in Figure 2-5).
 - b) If USB communication is used, connect the mini-USB male terminal to the mini-USB female connector labeled "USB" (12 in Figure 2-5). Connect the other end to the host PC.

Note: The Microchip serial emulator driver (`mchpcdc.inf`) should be installed on you PC in order to activate the USB-to-Serial emulator. The emulator driver is contained in the CD shipped with the dsPICDEM™ MCHV Development System.

4. Connect the SKDE cable. Connect the USB cable to the mini USB female connector labeled "Program/Debug" (14 in Figure 2-5). Connect the USB male terminal to the USB ports of the host PC.

Note: The built-in programmer/debugger is supported in MPLAB IDE 8.33 or higher.

5. Power Cord connection. Make sure the power cord is disconnected from the AC mains before connecting the female terminal of the power cable to the AC input connector (1, 2, and 3 in Figure 2-53) of the dsPICDEM™ MCHV Development System.

Note: The unit is designed to be connected to the AC mains supply via a standard non-locking plug. As the unit has no mains switch, this plug constitutes the means of disconnection from the supply. Therefore, the user must have unobstructed access to this plug during operation.

2.4 POWER SEQUENCES

The user should ensure that the following power sequences are adhered to.

2.4.1 Power-up Sequence

The unit is powered-up when the power cable is connected to the AC mains. To verify that the unit is powered make sure that the LEDs D6, D13, D17 and D18 are ON.

Note: The unit is designed to be connected to the AC mains supply via a standard non-locking plug. As the unit has no mains switch, this plug constitutes the means of disconnection from the supply and thus the user must have unobstructed access to this plug during operation.

2.4.2 Power-down Sequence

1. Stop firing all power devices by removing the PWM OUTPUTS shunt jumper.
2. Turn OFF the incoming AC supply by disconnecting the power cord from the mains.
3. Wait until the red DC bus LED indicator (D13) located next to the DC bus P connector has gone out (this will take 5 minutes or less).

2.4.3 Programming/Debugging an Application Code Using the Built-in Starter Kit Programmer/Debugger

The MPLAB Starter Kit Programmer/Debugger for the dsPICDEM™ MCHV Development System may be used with MPLAB IDE, the free integrated development environment, which is available from Microchip's web site (www.microchip.com). MPLAB IDE allows the Starter Kit to be used as an in-circuit debugger as well as a programmer for the following devices.

- dsPIC33FJ12MC202
- dsPIC33FJ32MC204
- dsPIC33FJ128MC804
- dsPIC33FJ256MC710

In-circuit debugging allows you to run, examine and modify your program for the device embedded in the Starter Kit hardware. This greatly assists you in debugging your firmware and hardware together.

Special Starter Kit software interacts with the MPLAB IDE application to run, stop, and single-step through programs. Breakpoints can be set and the processor can be reset. Once the processor is stopped, the register's contents can be examined and modified.

For more information on how to use MPLAB IDE, reference the following documentation:

- "MPLAB IDE User's Guide" (DS51519)
- "MPLAB IDE Quick Start Guide" (DS51281)
- MPLAB IDE Online Help

2.4.4 Setting Up an Application for Debug

To prepare the application for debug:

1. Launch MPLAB IDE, and then open the application project. The related workspace will be open. For information on projects and workspaces, see the MPLAB IDE documentation mentioned at the beginning of this chapter.
2. Select *Project>Build All* to build the application code. The build's progress will be visible in the **Build** tab of the Output window.

3. Select **Debugger>Select Tool>Starter Kits**. MPLAB IDE will change to add Starter Kit debug features (Figure 2-6): (1) the status bar will show Starter Kits as the debug tool, (2) a Starter Kit debug toolbar will be added, (3) the Debugger menu will change to add Starter Kit debug functions and (4) the Output window will display communication status between MPLAB IDE and the starter kit on the **Starter Kit Debugger** tab.

FIGURE 2-6: STARTER KIT AS A DEBUG TOOL

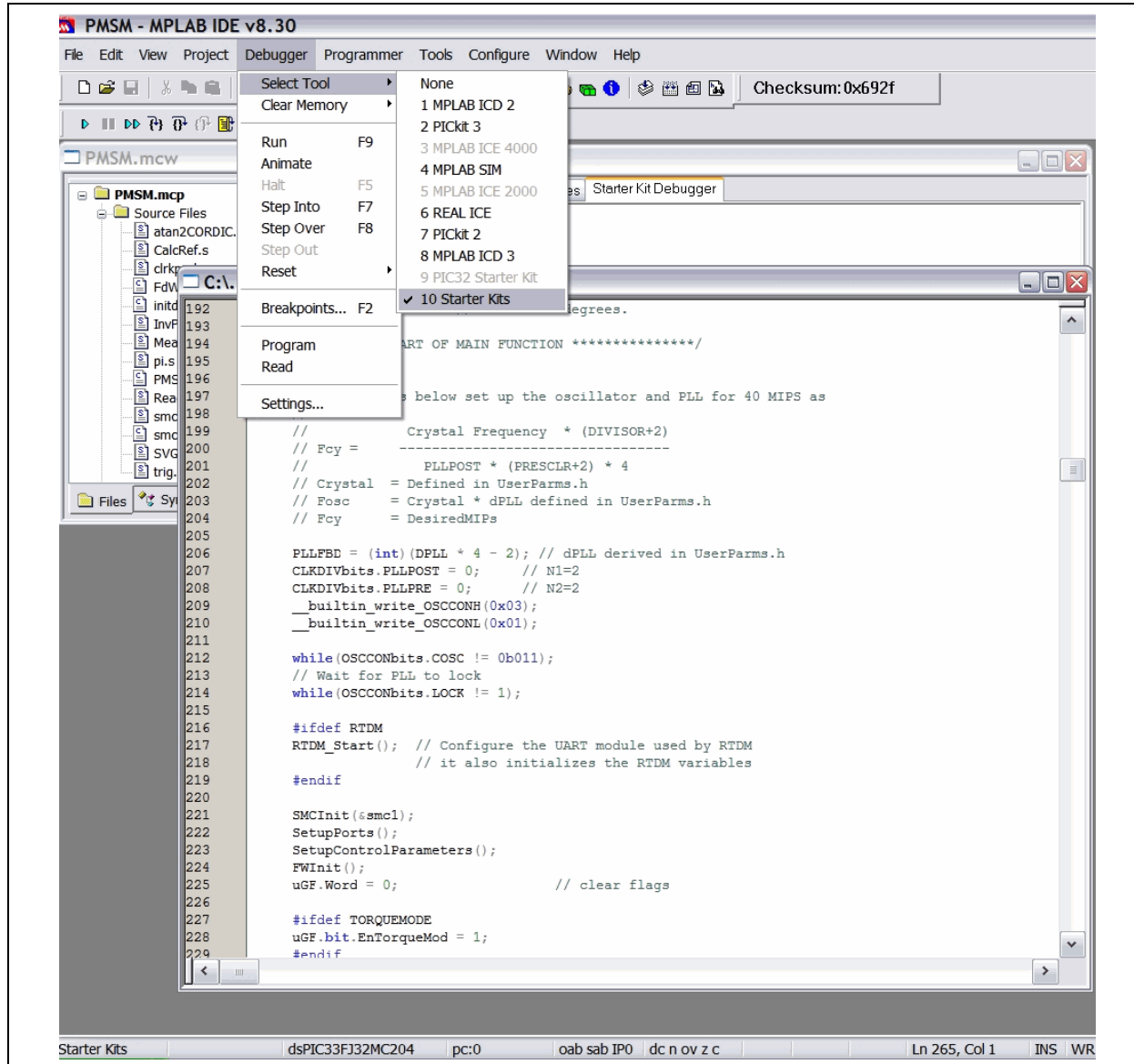

4. Select *Debugger>Program* to program the application code into the dsPIC33F DCS device on the Starter Kit. The debug programming progress will be visible in the **Starter Kit** tab of the Output window.

Note: Debug executive code is automatically programmed in the upper program memory of the Starter Kit device when the Starter Kit is selected as a debugger. Debug code must be programmed into the target device to use the in-circuit debugging capabilities of the Starter Kit.

2.4.4.1 RUNNING THE APPLICATION

The Starter Kit executes in either real-time (Run) or steps (Step Into, Step Over, and Animate) real-time execution occurs when you select Run in MPLAB IDE. Once the device code is halted, either by Halt or a breakpoint, you can step.

Toolbar buttons can be used for quick access to commonly used debug operations. Refer to **Section 3.3 “Running the Example Application”** in the “*MPLAB Starter Kit for dsPIC® Digital Signal Controllers User’s Guide*” (DS51700).

Note: All the peripherals are frozen when the “Halt” button is pressed to stop the program execution.

To see how these options function, do the following:

1. Select *Debugger>Reset>Processor Reset* or click the **Reset** button to reset the program.
2. Select *Debugger>Run* or click the **Run** button. Observe how the application operates.
3. Select *Debugger>Halt* or click the **Halt** button to stop the program execution. A green solid arrow will mark the line of code in the File window where the program halted.
4. Select *Debugger>Step Into* or click the **Step Into** button to step the program execution once. The green solid arrow will move down one line of code in the File window. Repeatedly click the button to step through the code.
5. Select *Debugger>Reset>Processor Reset* click the **Reset** button to reset the program again. The arrow will disappear, meaning the device is reset.

2.4.4.2 DEBUGGING THE APPLICATION

MPLAB IDE provides an editor and several debug features such as breakpoints and Watch windows to aid in application code debugging.

2.4.4.2.1 Editing Application Code

To view application code so it may be edited, do one of the following:

Select Edit>New to create new code or Edit>Open to search for and open an existing code file, or double click a file in the Project window to open an existing code file. See an example Project window in Figure 2-7.

FIGURE 2-7: PROJECT EXAMPLE

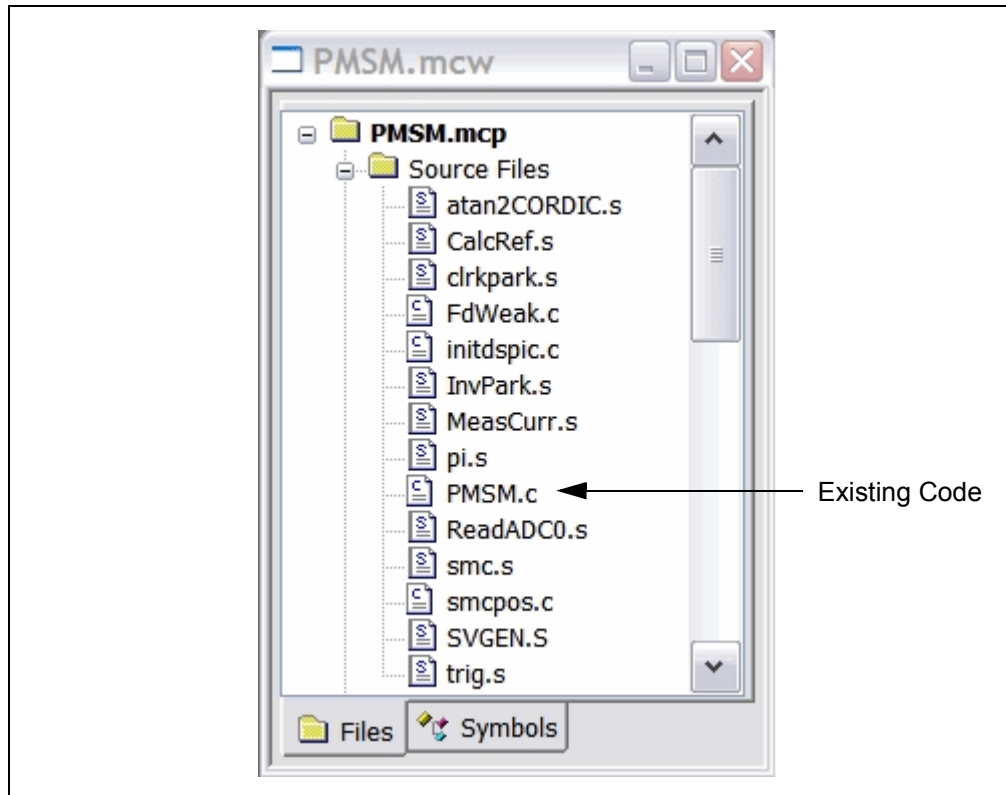

For more information on using the MPLAB Editor to create and edit code, see the MPLAB Editor Help.

2.4.4.2.2 Using Breakpoints and Mouseovers

To set a breakpoint in code:

1. Double click the gutter: Double click in the window gutter next to the line of code where you want the breakpoint. Double click again to remove the breakpoint.

Note: Double click must be set up for breakpoints. Select the *Edit>Properties*, and click the **ASM/C/BAS File Type** tab, and then select the “Double-click Toggles Breakpoint” check box.

2. Pop-up Menu: Place the cursor over the line of code where you want the breakpoint. Then, right-click to pop up a menu and select **Set Breakpoint**. Once a breakpoint is set, “Set Breakpoint” will become “Remove Breakpoint” and “Disable breakpoint”. Other options on the popup menu under Breakpoints are for deleting, enabling, or disabling all breakpoints.
3. Breakpoint Dialog: Open the Breakpoint dialog (*Debugger>Breakpoints*) to set, delete, enable, or disable breakpoints. See the MPLAB IDE Help for more information on this dialog.

A breakpoint set in code will appear as a red hexagon with a “B” as shown in Figure 2-8.

FIGURE 2-8: BREAKPOINT EXAMPLE

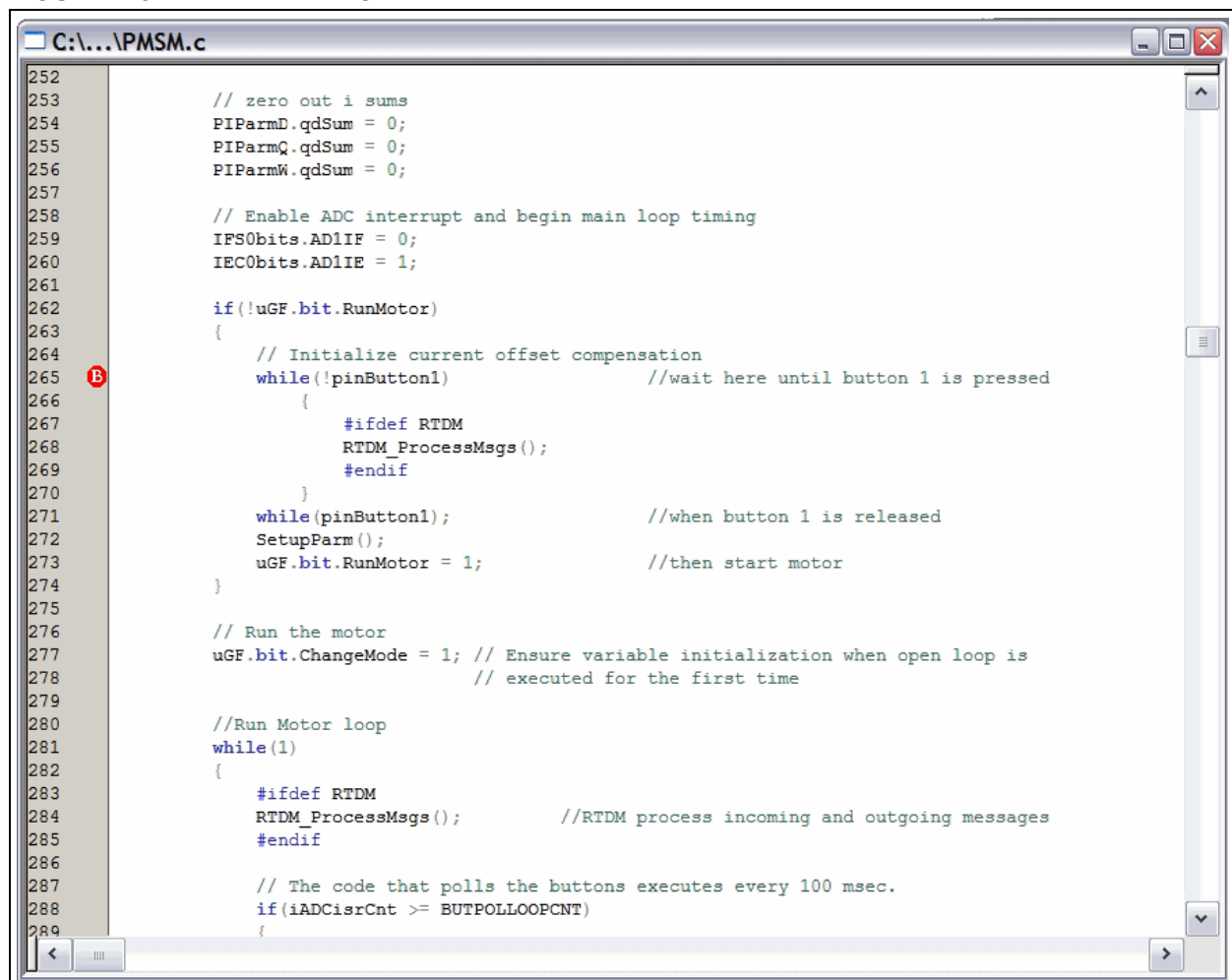

Once code is halted, hovering over a variables opens a tool tip window that contains the current value of the variable.

Note: This feature must be configured. Select *Edit>Properties* and click the **Tooltips** tab, and select the “Enable Variable Mouseover Values” check box.

2.4.4.2.3 Using Watch Windows

To use a Watch window:

1. The Watch window is made visible on the desktop by selecting *View>Watch*. It contains four selectable Watch views (via tabs) in which to view variables (SFRs, symbols and absolute addresses).
2. Select an SFR or Symbol from the list and click the related Add button to add it to the Watch window. Or click in the “Address” column and enter an absolute address.

A Watch window populated with an SFRs and Symbols will look like Figure 2-9. For more on using Watch windows, see MPLAB IDE Help.

FIGURE 2-9: WATCH WINDOW EXAMPLE

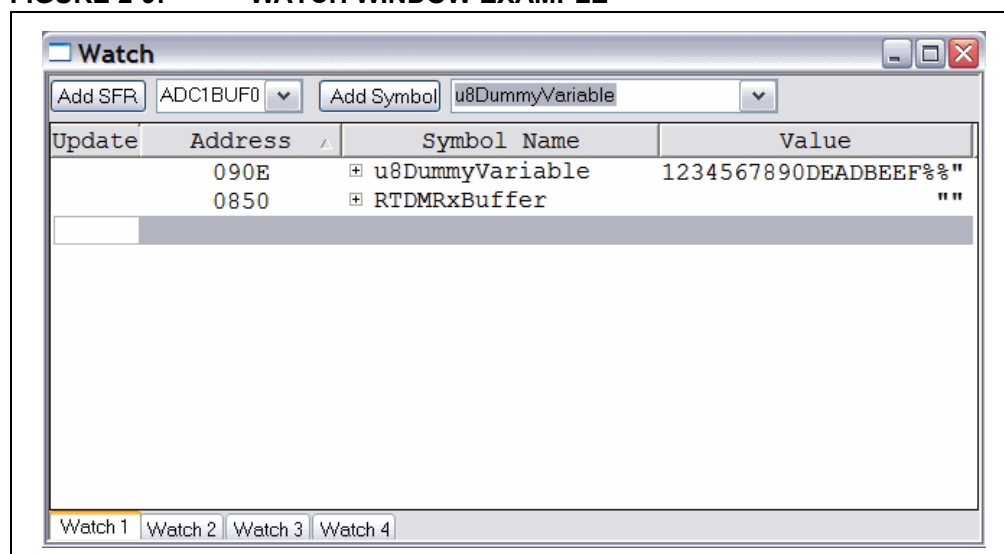

2.4.5 Programming an Application

When the program is successfully debugged and running, the next step is to program the device for stand-alone operation in the finished design. When doing this, the resources reserved for debug are released for use by the application. To program the application, use the following steps:

1. Disable Starter Kits as a debug tool by selecting *Debugger>Select Tool>None*.
2. Select Starter Kits as the programmer in the *Programmer>Select Programmer* menu.
3. Select *Programmer>Program*.

At this point, the application code will run independently.

2.4.6 Determining Device Support and Reserved Resources

Due to the built-in in-circuit debugging capability of ICD devices and the ICSP function offered by the debugger, the Starter Kit uses some on-chip resources when debugging. It also uses program memory and file register locations in the target device during debugging. These locations are not available for use by user code. In the MPLAB IDE, registers marked with an “R” in the register display represents reserved registers.

For information on device resources that are needed for in-circuit debugging, please refer to the MPLAB ICD 2 Help, found in MPLAB IDE under [Help>Topics](#). The device reserved resource information found under “Resources Used By MPLAB ICD 2” is the same for the Starter Kit.

2.4.7 Troubleshooting

2.4.7.1 DEBUG CONNECTION PROBLEMS

While using the Starter Kit as a debugger, you may receive the error “Starter Kit not connected to this computer” when programming the device. This can result from communication being lost between the Starter Kit and MPLAB IDE. To resolve this:

1. Unplug the USB cable from the Starter Kit.
2. Plug the USB cable back into the Starter Kit.

MPLAB IDE should automatically reconnect to the Starter Kit. If this does not work, do the following:

1. Check the USB connection between the PC and Starter Kit at both ends.
2. If using a USB hub, make sure it is powered.
3. Make sure the USB port is not in use by another device.

2.4.7.2 PROGRAMMING PROBLEMS

If during the course of developing your own application you can no longer program the device on the Starter Kit, you may have set device configuration bits to code protect or some other state that prevents programming. To view the settings of the configuration bits, select [Configure>Configuration bits](#).

2.4.8 Settings Dialog and Info Tab

When you select [Debugger>Settings](#) or [Programmer Settings](#), you will open the Starter Kit Settings dialog.

Currently, there is only one tab (**Info**) on this dialog, which provides the following information:

- Firmware Version: The version of firmware on the Starter Kit board.
- Debug Exec Version: The version of the debug executive that is loaded into the dsPIC33F device program memory to enable debug operation.

dsPICDEM™ MCHV Development System User's Guide

NOTES:

Chapter 3. Running the Demonstration

This chapter describes the demonstration software that is preloaded on the dsPIC33F device. This application software, which is based on application note AN984, demonstrates how to use the dsPICDEM™ MCHV Development System for controlling an AC induction motor (ACIM). For more information on this application note please refer to the following Microchip web page: www.microchip.com/dscmotor

To run the demo, follow these basic steps:

Note: Before making any connection, verify that the system is not powered and it is fully discharged. The system is completely discharged when the red LED D13 is off.

1. Connect the system by connecting the AC Induction Motor to the motor connector.
2. Power up the dsPICDEM™ MCHV Development System by connecting the power cord to the mains. To verify that the unit is powered, make sure that the LEDs D6, D13, D17, and D18 are ON. The very first time you connect the system to any host PC, you should briefly see a popup balloon in the system tray (lower right of desktop) that states (1) new hardware has been found, (2) drivers are being installed, and (3) new hardware is ready for use. If you do not see these messages and the Starter Kit does not work, try reconnecting the USB. If this does not work, see **Section 2.4.7 “Troubleshooting”**.

Note: The unit is designed to be connected to the AC mains supply via a standard non-locking plug. As the unit has no mains switch, this plug constitutes the means of disconnection from the supply. Therefore, the user must have unobstructed access to this plug during operation.

3. When powered up, the application will turn on the LEDs PWM1L1, PWM1L2 and PWM1L3.

To use the application, follow these steps:

- a) Make sure the PWM OUTPUT shunt jumper is installed.
- b) To start/stop the motor, press the switch labeled “PUSHBUTTON”.
- c) To increase the motor speed, rotate the potentiometer labeled “POT” clockwise. To reduce the speed, rotate the potentiometer counterclockwise.

NOTES:

Chapter 4. Hardware

This chapter describes the hardware components of the dsPICDEM™ MCHV Development System.

Topics covered include:

- Power Factor Correction (PFC) Stage Board
- Power Module Stage
- Electrical Specifications

4.1 POWER FACTOR CORRECTION (PFC) STAGE BOARD

This board has two main functions; the first one is to provide the required power supplies to the power module board stage. The second function is to create the power bus rail that will be used to energize the motor through the power module.

Note: The circuits for the hardware described in this section are shown in **Appendix A. “Board Layout and Schematics”**.

4.1.1 AC Supply Input

The AC supply input stage of the board consists of the following components,:

- F1 – 15A/250 VAC fast acting fuse (only replace with a part of the same rating)
- C1, C2 – Film capacitors to aid in the suppression of AC supply transients and to also provide a low impedance return path for any currents that flows from the power device tabs to the heat sink and enclosure due to capacitive coupling
- C3 – Film capacitor to aid in the suppression of AC supply transients.
- R1 – A metal oxide varistor located across the incoming supply lines to suppress high energy transients.
- L1 – 2.3 mH/15A Choke inductor for suppressing EMI
- C4 – Film capacitor to aid in the suppression of EMI
- C5, C6 – Film capacitors to aid in the suppression of AC supply transients and to also provide a low impedance return path for any currents that flow from the power device tabs to the heat sink and enclosure due to capacitive coupling
- R7 – A 1W high-voltage resistor, which acts to discharge C4
- R6 – A resistor with a negative temperature coefficient that acts to limit the surge of input current that would occur at initial application of power due to the discharged DC bus capacitance. The initial nominal cold resistance is 1 Ohm, which reduces once current flows and the device heats up.
- BR1 – A single-phase bridge rectifier to convert the incoming AC into DC suitable for input to the power conditioning stage.

4.1.2 Active Power Factor Correction (PFC)

The active PFC circuit is essentially a simple boost chopper with the control aimed at shaping the input current to follow the incoming mains supply waveform. The purpose of the different parts of the circuit is described below.

- L6 – A high frequency axial inductor with a single layer winding on a ferrite core. This component is in series with the main inductor (L7) to reduce the effect of the self-capacitance of its winding. Without L6, significant high frequency (15 MHz) ringing of the inductor current occurs at every transistor turn-on, which would increase EMI and the PFC transistor switching loss.
- L7 – A power inductor with three stacked toroidal cores made from a powdered-iron material to limit the core loss while maintaining good energy storage density. The particular cores used are Magnetics 0077083A7. A simple multi-layer winding is used which results in moderate copper loss but significant self-capacitance. Sixty-six turns of 1.5 mm diameter enameled copper wire is used. The design offers a good compromise between cost, core loss and size for this application. The nominal inductance is 1 mH at 10A.
- Q2 – A 600V TO-247 IGBT. As the tab of the device is not isolated, a thermally conductive insulator is used. When closed, Q2 increase the energy stored in the inductor L7. When open, energy stored in the inductance is transferred to the DC bus capacitors (C30-C32). Energy is also drawn from the AC supply during this time. By appropriate control of the switches, the input current waveform can be profiled to obtain good power factor and low harmonic distortion.
- D12 – A 600V TO-247 diode optimized for use at high switching frequency. As the tab of the device is not isolated, a thermally conductive insulator is used.
- C28, R31, R32, R33, D11 – A “snubber” that acts to damp high frequency oscillations and limit the rate of change of voltage across Q2
- C30, C31, C32 – 470 μ F/450V electrolytic capacitors which act as the main DC bus energy storage capacitors.
- R25, R26, C25, D8, Q1, R27, R28 – A level shifter to boost the PWM signal coming from the dsPIC DSC
- U19 – Microchip TC4421A gate drive IC. This contains a low resistance complementary push-pull MOSFET pair and input circuitry suitable for interfacing to a wide range of input voltages. It is an ideal choice for this application allowing up to 10A of peak gate drive current to switch Q2 rapidly and therefore achieve low switching loss. It also has a small footprint allowing it to be located physically close to the transistors allowing a low inductance gate circuit layout.
- D9, C26, C27 – These components act to provide a dynamic level shifting circuit to U19 while Q2 switch. Inductance of the power tracking between the source of Q2 due to the physical board layout means there is a substantial transient voltage between the +15V supply point reference at R28 and the source of Q2. This simple low cost circuit allows the power supply of U19 to move transiently.
- R75, R29 and D10 – These components control the current and voltage to turn on and turn off the IGBT. R29 controls the rising time and the di/dt when the IGBT is turned on. R29 in parallel with R75 control the falling time and the di/dt when the IGBT is turned off.
- The power factor corrector design is based on the application note AN1106, for more information on this application note please refer to one of the following Microchip Web sites:
 - www.microchip.com/smps
 - www.microchip.com/dscmotor

4.1.3 PFC Feedback Circuitry

In a DSC-based PFC, the relevant analog parameters and the control loops need to be redefined and discretized. This enables changeover from existing hardware to its digital counterpart easier and more logical.

The PFC is an AC-to-DC converter, which converts the AC input voltage to a DC voltage and maintains sinusoidal input current at a high input power factor. In a DSC-based PFC, three inputs signals are required to implement the current control.

The input rectifier (BR1) converts (shown in **Section 4.1.1 “AC Supply Input ”**) the alternating voltage at power frequency into unidirectional voltage. This rectified voltage is fed to the chopper circuit to produce a smooth and constant DC output voltage to the load. The chopper circuit is controlled by the PWM switching pulses generated by the dsPIC DSC device, based on three measured feedback signals:

- Rectified input voltage
- AC input voltage zero-crossing event
- Rectified input current
- DC bus voltage

The rectified input voltage is measured in two stages:

- Signal conditioning: R22, R23, R24, C24, and D7 convert and filter the AC input voltage waveform from 90-265 VAC to 0-3.3 VAC. D7 limit the maximum voltage to 3.3V. C24 along with R22, R23 form a low-pass filter. The circuit is shown in Appendix A.
- Amplification: the operational amplifier MCP6024 (U13B) amplifies the conditioned AC input voltage; R45, R46, R47, R48, R49 and R51 set the gain. The MCP6024 also shifts the conditioned AC input voltage to a 1.65V DC level. Therefore, the voltage applied to the dsPIC DSC ADC channel varies within 0-3.3V. The offset is controlled by R50, R53, and R54. R39 and C39 filter out the high-frequency noise.

AC input voltage zero-crossing event is sensed using a voltage divider (R2-R5) and two opto-couplers (U1 and U2). The circuit is shown in Appendix A.

Rectified input current is measured using the shunt resistor R34 and the operational amplifier MCP6024 (U13A); R38, R39, R40, R41, R42 and R43 set the gain. R43 shifts the voltage present at the shunt resistor to a 1.65V DC level. Therefore, the voltage applied to the dsPIC DSC ADC channel varies within 0-3.3V. The offset is controlled by R43, R53, and R54. R44 and C37 filter out the high-frequency noise. The circuit is shown in Appendix A.

DC bus voltage, the DC bus voltage is sensed at the power module stage. Please refer to **Section 4.2.4 “Feedback Circuitry”**.

4.1.4 Power Supplies

The PFC stage board provides the 15 volts power supply required to fire the power module IGBTs. The 15 volts power supply is built using a low power off-line SMPS primary switcher. The switching frequency is fixed to 60 kHz, the feedback signal to the power supply is provided by and opto-coupler. The output voltage is regulated at 15V with a maximum output current of 0.750 A, the resultant maximum power is 11.25 W. The input voltage range for this power supply is from 90 VAC to 260 VAC.

The PFC stage board also provides the 3.3 volts to powering-up the dsPIC DSC, the isolation circuitry, the communication ports, the Starter Kit programmer, etc. It also generates the 3.3 volts for powering the analog circuits and the analog reference for the Analog-To-Digital converter.

The 3.3 volts rail is created using a step-down regulator which is attached to the 15 volts regulator. The maximum output current is 0.650 A, thus the resultant maximum power is 2.145 W.

The 3.3 volts rail required for the analog circuits such as the current feedback and the Analog-to-digital converter is generated by a decoupling circuitry attached to the 3.3 volts regulator.

4.1.5 Fault Circuitry

Given the development nature of the system, robust independent FAULT protection is provided on the PFC Stage Board. Two different fault categories are used to indicate a FAULT to the dsPIC® DSC.

DC Bus Overcurrent, this fault signal is generated when the maximum current limit of 15A is reached. The comparison of the threshold value and the actual current is done by comparator U8. The threshold limit is set by R56 and R57. R69 is a shunt jumper resistor that can disconnect the overcurrent fault to the dsPIC DSC.

DC Bus Overvoltage, this fault signal is generated when the maximum voltage limit on the DC bus rails is reached. The threshold value is set to 432 V. The comparison of the threshold value and the actual DC bus voltage is done by comparator U7. The threshold limit is set by R60, R61 and R62. R66 is a shunt jumper resistor that can disconnect the overvoltage fault to the dsPIC DSC.

Note: Both comparators are open-drained and need an external pull-up resistor. Both circuits share this pull-up resistor creating an OR condition at the output.

4.1.6 Board Connectors

The PFC stage board has four tab fast-on connectors, one AC inlet and one 14-pin keyed connector for attaching a flat cable.

For the AC mains supply input, standard double-insulated, 3-core flex cable should be used with a minimum current rating of 10A (1 mm² 18 AWG). A computer power cable can be used. The recommended cable size is 1.0 to 1.5 mm² (18-16 AWG) and it should have a 600V rating. This cable should also be double insulated or have a protective ground screen.

- Note 1:** The system is designed for installation category II. Therefore, the incoming mains cable should be wired into a standard non-locking 2-pin in addition with an earth ground type plug.
- 2:** The unit is designed to be connected to the AC mains supply via a standard non-locking plug. As the unit has no mains switch, this plug constitutes the means of disconnection from the supply. Therefore, the user must have unobstructed access to this plug during operation.

The tab fast-on connectors AC_N and AC_L provides the connections to the bridge rectifier BR1. The recommended cable size is 16-18 AWG or 1.0 to 1.5mm². It is also recommended that cables used for the power connections should be terminated with blue or red crimp terminals. If crimp terminals are not used, care should be taken to ensure that stray strands of wire do not short to adjacent terminals or the enclosure. If possible, all wires should be stripped and tinned with solder before connecting to the dsPICDEM MCHV development board terminals.

The fast-in connectors PFC_OUT “+” and PFC_OUT “-” provide DC bus voltage to the Power Module Stage. The recommended cable size is 16-18 AWG or 1.0 to 1.5mm². It is also recommended that cables used for the power connections should be terminated with blue or red crimp terminals. If crimp terminals are not used, care should be taken to ensure that stray strands of wire do not short to adjacent terminals or the enclosure. If possible, all wires should be stripped and tinned with solder before connecting to the dsPICDEM MCHV development board terminals.

Note: The user should only access the power terminals when the system is fully discharged (see the “**Safety Notice**” on page iii).

The 14-pin keyed connector provides the signals and power supply rails from and to the Power Stage. These signals are shown in Table 4-1.

TABLE 4-1: 14-PIN KEYED CONNECTORS

Number	Name	Type
1	3.3V, digital rail	Output
2	Not Connected	NC
3	3.3V, analog rail	Output
4	AC input voltage feedback	Output
5	Ground, analog rail	Output
6	AC input current feedback	Output
7	Fault (Overcurrent OR Overvoltage condition)	Output
8	VAC zero crossing signal	Output
9	Ground, digital rail	Output
10	PWM signal for the PFC IGBT	Input
11	Ground, digital rail	Output
12	Not Connected	NC
13	15V	Output
14	Not Connected	NC

4.2 POWER MODULE STAGE

This board has two main functions; the first is to control the motor using a dsPIC DSC and a Power Module and the associated feedback signals for each control algorithm. The second is to provide the safety means to interact with the user.

Note: The circuits for the hardware described in this section are shown in **Appendix A. “Board Layout and Schematics”**.

4.2.1 Plug-In Module Configuration

This section summarizes the resistor configuration required to connect the PIM pins to dsPIC DSC pins. The following PIMs can be configured on the dsPICDEM™ MCHV Development System:

- dsPIC33FJ256MC710 PIM (MA330013)
- dsPIC33FJ12MC202 PIM (MA330014)
- dsPIC33FJ32MC204 PIM (MA330017)
- dsPIC33FJ128MC804 PIM (MA330018)

Note: When using PIMs, make sure that the 28-pin SOIC dsPIC DSC is removed from the dsPICDEM™ MCHV Development System.

dsPICDEM™ MCHV Development System User's Guide

Table 4-2, Table 4-3, and Table 4-4 describe the PIM configuration details.

TABLE 4-2: dsPIC33FJ12MC202 PIM CONFIGURATION DETAILS

PIM Pin Number	Labels on the dsPICDEM™ MCHV Development System	dsPIC33FJ12MC202 dsPIC33FJ32MC202 dsPIC33FJ64MC202 dsPIC33FJ128MC202 dsPIC33FJ32MC302 dsPIC33FJ64MC802 dsPIC33FJ128MC802		PIM Resistor Configuration
		Pin Number	Pin Name	
93	PWM1L1	23	PWM1L/RP15/CN11/RB15	R19
94	PWM1H1	22	PWM1H1/RP14/CN12/RB14	R18
98	PWM1L2	21	PWM1L2/RP13/CN13/RB13	R17
99	PWM1H2	20	PWM1H2/RP12/CN14/RB12	R16
100	PWM1L3	19	TMS/PWM1L3/RP11/CN15/RB11	R15
3	PWM1H3	18	TDI/PWM1H3/RP10/CN16/RB10	R12
71	PWM2L1	15	TDO/PWM2L1/SDA1/RP9/CN21/RB9	R14, Remove R13
18	FAULT	14	TCK/PWM2H1/SCL1/RP8/CN22/RB8	R11
19	PFC_FLT	15	TDO/PWM2L1/SDA1/RP9/CN21/RB9	Remove R13
26	PGC	9	PGEC3/SOSCO/T1CK/CN0/RA4	Not applicable
27	PGD	8	PGED3/SOSCI/RP4/CN1/RB4	Not applicable
63	OSI	6	OSCI/CLKI/CN30/RA2	Not applicable
64	OSO	7	OSCO/CLKO/CN29/RA3	Not applicable
25	IPFC	27	PGED2/AN0/VREF+/CN2/RA0	R24, Remove R27
24	VACZX_VAC_POT	28	PGEC2/AN1/VREF-/CN3/RA1	R25, Remove R26
35	VBUS	1	PGED1/AN2/RP0/CN4/RB0	R20, Remove R28
41	MONITOR_1	2	PGEC1/AN3/RP1/CN5/RB1	R21, Remove R31
42	MONITOR_2	3	AN4/RP2/CN6/RB2	R22, Remove R30
43	MONITOR_3	4	AN5/RP3/CN7/RB3	R23, Remove R29
—	HA/QEA	—	Not connected	Not applicable
—	HB/QEB	—	Not connected	Not applicable
—	HC/INDX	—	Not connected	Not applicable
—	VA	—	Not connected	Not applicable
—	VB	—	Not connected	Not applicable
—	VC	—	Not connected	Not applicable
—	IA	—	Not connected	Not applicable
—	IB	—	Not connected	Not applicable
—	IBUS	—	Not connected	Not applicable
—	VAC	—	Not connected	Not applicable
—	POT	—	Not connected	Not applicable
—	VACZX	—	Not connected	Not applicable
70	RX	70	INT0/RP7/CN23/RB7	R10, Remove R9
84	TX	84	ASCL1/RP6/CN24/RB6	R32, Remove R7 and R8
—	USB_RX	—	Not connected	Not applicable
—	USB_TX	—	Not connected	Not applicable
68	BTN		ASDA1/RP5/CN27/RB5	R6, Remove R5 and R33

TABLE 4-3: dsPIC33FJ32MC204 AND dsPIC33FJ128MC804 PIM CONFIGURATION DETAILS

PIM Pin Number	Labels on the dsPICDEM™ MCHV Development System	dsPIC33FJ32MC204 dsPIC33FJ64MC804 dsPIC33FJ128MC804		PIM Resistor Configuration
		Pin Number	Pin Name	
93	PWM1L1	15	PWM1L1/RP15/CN11/RB15	R11
94	PWM1H1	14	PWM1H1/RP14/CN12/RB14	R10
98	PWM1L2	11	PWM1L2/RP13/CN13/RB13	R9
99	PWM1H2	10	PWM1H2/RP12/CN14/RB12	R7
100	PWM1L3	9	PGEC2/PWM1L3/RP11/CN15/RB11	R8
3	PWM1H3	8	PGED2/PWM1H3/RP10/CN16/RB10	R6
78	PWM2L1	3	PWM2L1/RP23/CN17/RC7	R31
18	FAULT	44	SCL1/RP8/CN22/RB8	R4
19	PFC_FLT	1	SDA1/RP9/CN21/RB9	R1
26	PGC	42	PGEC3/ASCL1/RP6/CN24/RB6	Not applicable
27	PGD	41	PGED3/ASDA1/RP5/CN27/RB5	Not applicable
63	OSI	30	OSCI/CLKI/CN30/RA2	Not applicable
64	OSO	31	OSCO/CLKO/CN29/RA3	Not applicable
25	IPFC	19	AN0/VREF+/CN2/RA0	R12
24	VACZX_VAC_POT	20	AN1/VREF-/CN3/RA1	R13
35	VBUS	21	PGED1/AN2/C2IN-/RP0/CN4/RB0	R14
41	MONITOR_1	22	PGEC1/AN3/C2IN+/RP1/CN5/RB1	R22
42	MONITOR_2	23	AN4/RP2/CN6/RB2	R25
43	MONITOR_3	24	AN5/RP3/CN7/RB3	R21
72	HA/QEA	37	RP20/CN25/RC4	R29
76	HB/QEB	38	RP21/CN26/RC5	R30
77	HC/INDX	2	PWM2H1/RP22/CN18/RC6	R32
—	VA	—	Not connected	Not applicable
—	VB	—	Not connected	Not applicable
—	VC	—	Not connected	Not applicable
—	IA	—	Not connected	Not applicable
—	IB	—	Not connected	Not applicable
—	IBUS	—	Not connected	Not applicable
—	VAC	—	Not connected	Not applicable
—	POT	—	Not connected	Not applicable
—	VACZX	—	Not connected	Not applicable
70	RX	43	INT0/RP7/CN23/RB7	R3, Remove R26
84	TX	33	SOSCI/RP4/CN1/RB4	R20
—	USB_RX	—	Not connected	Not applicable
—	USB_TX	—	Not connected	Not applicable
68	BTN	4	RP24/CN20/RC8	R2, Remove R18

dsPICDEM™ MCHV Development System User's Guide

TABLE 4-4: dsPIC33FJXXXMC710 PIM CONFIGURATION DETAILS

PIM Pin Number	Labels on the dsPICDEM™ MCHV Development System	dsPIC33FJ64MC710 dsPIC33FJ128MC710 dsPIC33FJ256MC710		PIM Resistor Configuration
		Pin Number	Pin Name	
93	PWM1L1	93	PWM1L/RE0	Not applicable
94	PWM1H1	94	PWM1H/RE1	Not applicable
98	PWM1L2	98	PWM2L/RE2	Not applicable
99	PWM1H2	99	PWM2H/RE3	Not applicable
100	PWM1L3	100	PWM3L/RE4	Not applicable
3	PWM1H3	3	PWM3H/RE5	Not applicable
78	PWM2L1	78	OC4/RD3	Not applicable
18	FAULT	18	AN20/FLTA/INT1/RE8	Not applicable
19	PFC_FLT	19	AN21/FLTB/INT2/RE9	Not applicable
26	PGC	26	PGEC1/AN6/OFCA/RB6	Not applicable
27	PGD	27	PGED1//AN7/RB7	Not applicable
63	OSI	63	OSC1/CLKIN/RC12	Not applicable
64	OSO	64	OSC2/CLKO/RC15	Not applicable
25	IPFC	25	PGED3/AN0/CN2/RB0	Not applicable
24	VACZX_VAC_POT	24	PGEC3/AN1/CN3/RB1	Not applicable
35	Not applicable	35	AN11/RB11	Not applicable
23	VBUS	23	AN2/SS1/CN4/RB2	Not applicable
41	Not applicable	41	AN12/RB12	Not applicable
22	MONITOR_1	22	AN3/INDX/CN5/RB3	Not applicable
42	Not applicable	42	AN13/RB13	Not applicable
21	MONITOR_2	21	AN4/QEA/CN6/RB4	Not applicable
43	Not applicable	43	AN14/RB14	Not applicable
20	MONITOR_3	20	AN5/QEB/CN7/RB5	Not applicable
80	HA/QEA	80	IC6/CN19/RD13	Not applicable
47	HB/QEB	47	IC7/U1CTS/CN20/RD14	Not applicable
48	HC/INDX	48	IC8/U1RTS/CN21/RD15	Not applicable
—	VA	—	Not connected	Not applicable
—	VB	—	Not connected	Not applicable
—	VC	—	Not connected	Not applicable
—	IA	—	Not connected	Not applicable
—	IB	—	Not connected	Not applicable
—	IBUS	—	Not connected	Not applicable
—	VAC	—	Not connected	Not applicable
33	POT	33	AN9/RB9	Not applicable
79	VACZX	79	IC5/RD12	Not applicable
49	RX	49	U2RX/CN17/RF4	Not applicable
50	TX	50	U2TX/CN18/RF5	Not applicable
—	USB_RX	—	Not connected	Not applicable
—	USB_TX	—	Not connected	Not applicable
68	BTN	68	IC1/RD8	Not applicable

4.2.2 Power Supplies

The system default configuration is to get the 15V, 3.3V and 3.3V analog rail voltages from the PFC stage board. However, it is also possible to use an external 24V power supply to generate these voltages.

U19, C70, C73, C71 and C74 regulate the voltage applied to the system via J15 (28V max). The output of the regulator is connected to the system through R109. The circuit is shown in **Appendix A. “Board Layout and Schematics”**.

Note: It is the responsibility of the user to populate these components if an external power supply is used.

U18, C67, R110, C68, D16, D15, L3, R111, R112 and C75 regulate the 15 volts to create a 3.3V digital rail. This auxiliary 3.3V digital rail is applied to the system through R106. The circuit is shown in **Appendix A. “Board Layout and Schematics”**.

Note: It is the responsibility of the user to populate these components if an external power supply is used.

R114, R107, C69, and C72 form a decoupling circuit for generating a 3.3V rail for the analog circuitry such as the ADC reference and the current feedback reference. This auxiliary 3.3V analog rail is applied to the system through R108.

Note: It is the responsibility of the user to populate these components if an external power supply is used.

4.2.3 Power Module

The three-phase inverter is embedded in a power module (U16). This power module contains:

- 600V/30A 3-phase IGBT Inverter Bridge
- Gate driver circuitry for each IGBT
- Three Independent connections to the negative DC bus for current sensing
- Short-circuit protection circuitry
- Thermal Shutdown
- Gate Driver Power Supply Undervoltage protection
- Gate Driver Power Supply Overvoltage protection
- Single-grounded power supply
- Isolation of 2.5 kV per minute
- Maximum switching frequency: 20 kHz

The dsPIC DSC provides the PWM signals to this power module in order to turn on/off the IGBT, and therefore apply power to the motor phases.

R95 sets the threshold limit for the overcurrent circuitry. If this voltage is greater than 0.5 V (typical), a fault signal is asserted and the low-side IGBTs are turned off. R94 and C53 form a low-pass RC filter that filters out the frequencies above 88.4 kHz.

C56 sets the fault pulse duration, the value of C56 is given by the following equation: $C56 = 18.3E-6 \times 1.8E-3$ seconds. Therefore, the fault pulse duration is 54 μ s

The power module fault output pin (VFO) is open-collector configured. R50 pulls up the fault output to the analog 3.3V rail. R53 and C40 form a low-pass RC filter that filters out the frequencies above 53 kHz.

For more information about this power module please refer to the manufacturer’s data sheet.

4.2.4 Feedback Circuitry

The Power Module Stage provides three different methods to sense the motor position. These signals are also useful to determine the speed, the torque, current consumption and the applied voltage.

Hall Sensors, the hall sensors circuitry is designed to attach open-collector configured sensors. It has a pull-up resistor at the hall sensor inputs (R23, R24, and R25) and a voltage divider (R26-R29, R27-R30, R28-R31) in order to scale the input waveforms to the dsPIC DSC logic levels. C25-C27 and R26-R28 form a low-pass RC filter for each hall sensor signal.

Phase Voltage Feedback circuitry for each phase is compounded by a voltage divider, a current limiter and a low-pass RC filter. R79, R84 and R92 scale the phase M1 voltage in order to match the dsPIC DSC logic levels. R85 limits the current going to the ADC pin (< 6mA). C51, R79 and R84 form the low-pass filter. The phase M2 and M3 has the exact same circuitry as shown in the schematic.

DC Bus Voltage Feedback is compounded by a voltage divider and a low-pass RC filter. R75, R76 and R81 scale the DC bus voltage in order to match the dsPIC DSC logic levels. C47, R75 and R76 form the low-pass filter.

Inverter Leg Shunt Resistor Feedback, a shunt resistor is located between the emitter of the low side switches M1 and M2 and the “-DC bus”. A simple differential amplifier circuit is used as shown in Appendix A. The operation of the circuit used for the M1 phase leg is described below:

The current is measured using the shunt resistor R86 and the operational amplifier MCP6024 (U13A); R32, R33, R34, R36, R37 and R38 set the gain. R38 shifts the voltage present at the shunt resistor to a 1.65V DC level. Hence the voltage applied to the dsPIC DSC ADC channel varies within 0-3.3V. The offset is controlled by R59, R60, R38 and U13D. R35 and C34 filter out the high-frequency noise.

The same topology is used for the phase M2.

DC Bus Current Feedback, a shunt resistor is located between the shunt resistors of side switches M1 and M2 and the “-DC bus”. A simple differential amplifier circuit is used as shown in the schematic. The operation of the circuit used for sensing the DC bus current is described as follows:

The current is sensed using the shunt resistor R95 and the operational amplifier MCP6024 (U13C); R51, R52 and R49 set the gain. R58 shifts the voltage present at the shunt resistor to a 1.65V DC level. Hence the voltage applied to the dsPIC DSC ADC channel varies within 0-3.3V. The offset is controlled by R59, R60, R58 and U13D. R54 and C42 filter out the high-frequency noise.

Note: It is possible to select any of these feedback signals using jumpers J12, J13 and J14, please refer to **Section 4.2.8 “User Interfaces”** for more information.

4.2.5 Fault Circuitry

In addition to the fault signal generated by the power module, the system can also create a DC bus overcurrent fault.

DC Bus Overcurrent, this fault signal is generated when the maximum current limit of 15A is reached. The comparison of the threshold value and the actual current is done by comparator U14. The threshold limit is set by R42 and R47. R69 is a shunt jumper resistor that can disconnect the overcurrent fault from the dsPIC DSC.

Note: The comparator is open-drained and needs an external pull-up resistor. Both the power module output and the comparator output share this pull-up resistor creating an OR condition at the output.

4.2.6 Isolation

The power supply used by the push buttons, communication ports, and the SKDE programmer/debugger is isolated from the power supply used by the power module or the dsPIC DSC. An isolated 3.3V rail is generated from the digital 3.3V rail using a DC-to-DC converter (U10). This converter provides galvanic isolation rated up to 1000 V_{DC}/1 second.

4.2.7 Communication Ports

The power module stage board provides two methods for transmitting/receiving data to and from the system. Both communication methods are powered using the isolated 3.3V rail.

UART-to-USB communication port is based on a PIC18LFJ2450 device with a serial emulator firmware. This device translates the USB signals to dsPIC DSC UART compatible signals. The firmware used for this serial emulator is enclosed in the CD shipped along with the unit. Isolation for the UART-to-USB communication port is provided by U25.

UART-to-RS-232 communication port is based on a RS-232 transceiver (U9). This device translates the dsPIC DSC UART signals to UART compatible signals. Isolation for the UART-to-RS-232 communication port is provided by U25.

Shunt jumpers J2 and J3 select the communication port. Table 4-5 shows the possible configurations.

TABLE 4-5: COMMUNICATION PORT CONFIGURATION

Designator	Position	Description
J2	1-2	Connects UART receive line to RX.
	2-3	Connects USB receive line to RX.
J3	1-2	Connects UART transmit line to TX.
	2-3	Connects USB transmit line to TX.

4.2.8 User Interfaces

There are two types of user interfaces, isolated and non-isolated:

- Isolated interfaces:
 - Potentiometer labeled “POT” (R14)
 - RESET push button
 - PUSH BUTTON (S1)
 - PWM OUTPUT enable shunt jumper (J7)
 - Communication Port Selection shunt jumper (J2 and J3)
 - ICSP programmer/debugger connector for SKDE (J4)
 - ICSP programmer/debugger connector for UART-to-USB converter (J1)
- Non-Isolated interfaces:
 - 15V Power Supply LED (D17)
 - 3.3V Power Supply LED (D18)
 - PWM2L1, PWM1L1, PWM1H1, PWM1L2, PWM1H2, PWM1L3, PWM1H3 LEDs
 - USB communication LED (D1)
 - USB cable connected LED (D3)
 - SKDE USB cable connected LED (D21)
 - SKDE Power On LED (D19)
 - ICSP programmer/debugger connector for dsPIC DSC (J18)
 - Feedback Selection Shunt Jumpers J11, J12, J13, and J14.

Table 4-6 shows the multiple feedback signals that can be selected.

TABLE 4-6: MULTIPLE FEEDBACK SIGNALS

Designator	Position	Description
J11	1-2	Connects AC input voltage zero-crossing event to VACZX_VAC_POT
	3-4	Connects AC input voltage to VACZX_VAC_POT
	5-6	Connects the POT voltage to VACZX_VAC_POT
J12	1-2	Connects Phase M1 shunt current feedback to MONITOR_1
	3-4	Connects Phase M1 voltage feedback to MONITOR_1
	5-6	Connects Hall A/QEA sensor signal to MONITOR_1
J13	1-2	Connects Phase M2 shunt current feedback to MONITOR_2
	3-4	Connects Phase M2 voltage feedback to MONITOR_2
	5-6	Connects Hall B/QEB sensor signal to MONITOR_2
J14	1-2	Connects DC bus shunt current feedback to MONITOR_3
	3-4	Connects Phase M3 voltage feedback to MONITOR_3
	5-6	Connects Hall C/INDEX sensor signal to MONITOR_3
	7-8	Connects the POT voltage to MONITOR_3

4.2.9 Hardware for Programming and Debugging

The dsPICDEM™ MCHV Development System, with its built-in SKDE debugger/programmer, provides an all-in-one solution for debugging and programming applications using MPLAB IDE. The Starter Kit's debugging/programming operations are controlled by a PIC18F67J50 MCU running at 48 MHz. The PIC18F67J50's built-in USB engine provides the communications interface between the Starter Kit and the host PC.

Power to the Starter Kit is provided via the isolated 3.3V rail. Proper Starter Kit main system power is indicated by the green LED D19. The PIC18F67J50 MCU accomplishes debugging or programming of the target dsPIC33F by controlling the target's MCLR, PGC1/EMUC1, and PGD1/EMUD1 signals. A Microchip 25LC010A serial EEPROM is used to store the Starter Kit's serial number and debug control information. Isolation for the MCLR, PGC1/EMUC1, and PGD1/EMUD1 signals is provided by the digital isolators U22, U23, U1 and U3.

4.2.10 Board Connectors

Figure 4-1 provides the locations of the connectors. The Power Module Stage Board connectors are listed in Table 4-6.

FIGURE 4-1: POWER MODULE BOARD CONNECTORS

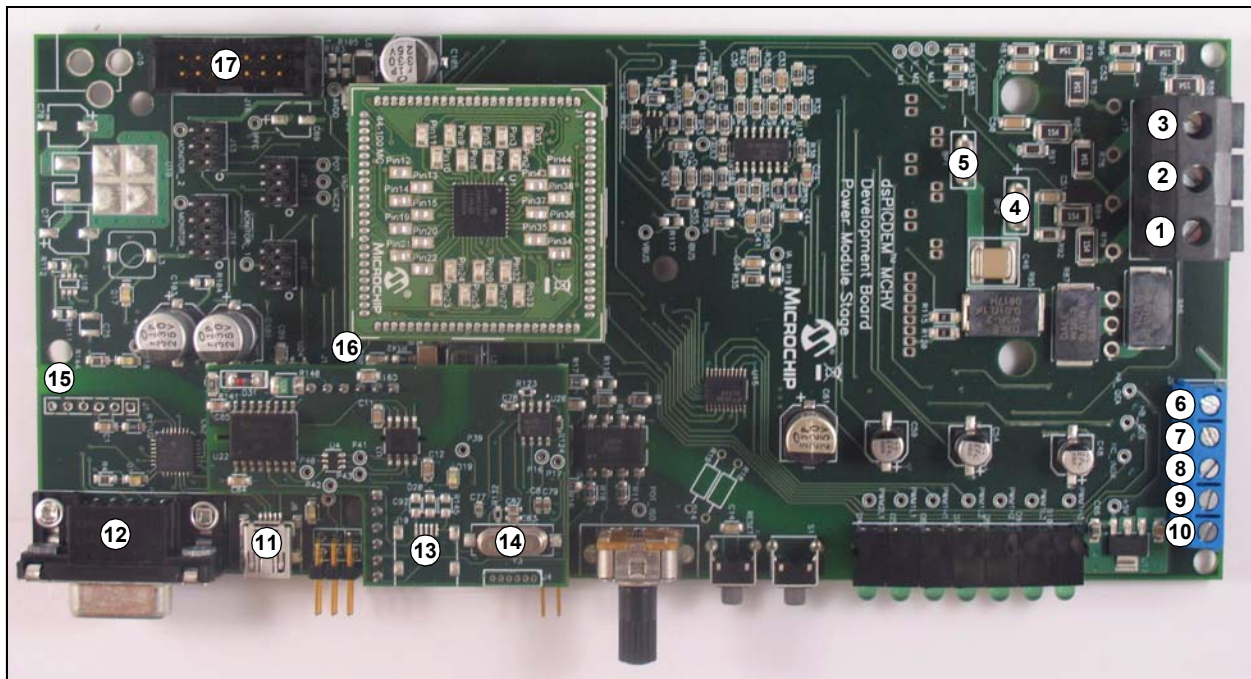

TABLE 4-7: POWER MODULE STAGE BOARD CONNECTORS

Number	Designator	Type
1	Motor Phase 1 (M1)	Output/Power
2	Motor Phase 2 (M2)	Output/Power
3	Motor Phase 3 (M3)	Output/Power
4	DC Bus “+”	Input/Power
5	DC Bus “-”	Input/Power
6	Hall Sensor A (HA)	Input
7	Hall Sensor B (HB)	Input
8	Hall Sensor C (HC)	Input
9	Hall Sensors, 5V power supply terminal	Output/Power
10	Hall Sensors, Ground terminal	Output/Power
11	UART-to-USB connector	Input/Output
12	UART-to-RS-232 connector	Input/Output
13	USB connector for the Starter Kit Programmer/Debugger	Input/Output
14	Isolated ICSP™ programmer/debugger connector for SKDE (J4)	Input/Output
15	Isolated ICSP programmer/debugger connector for UART-to-USB converter (J1)	Input/Output
16	ICSP programmer/debugger connector for dsPIC DSC (J18)	Input/Output
17	14-pin keyed connector (J16)	Input/Output/Power

The 14-pin keyed connector provides the signals and power supply rails from and to the Power Module Stage. These signals are shown in Table 4-8.

TABLE 4-8: 14-PIN KEYED CONNECTORS

Number	Name	Type
1	3.3V, digital rail	Output
2	Not Connected	NC
3	3.3V, analog rail	Output
4	AC input voltage feedback	Output
5	Ground, analog rail	Output
6	AC input current feedback	Output
7	Fault (Overcurrent or Overvoltage condition)	Output
8	VAC zero crossing signal	Output
9	Ground, digital rail	Output
10	PWM signal for the PFC IGBT	Input
11	Ground, digital rail	Output
12	Not Connected	NC
13	15V	Output
14	Not Connected	NC

4.3 ELECTRICAL SPECIFICATIONS

The maximum power and current capability of the system is dictated by the allowable temperature rise of the different components. Establishing maximum limits is not simple given the host of different ways the user may use the system. The voltage and the nature of the electrical load used both affects the dissipation that occurs. In determining the allowable limits for the power semiconductors, the following assumptions have been made:

- Heat sink is at 70°C (worst case)
- Thermal resistance of the insulating thermal pad is 3°C/W

TABLE 4-9: INVERTER ELECTRICAL SPECIFICATIONS

Parameter	Min	Typ	Max	Units
DC Bus	40	310	400	V _{DC}
Current	0.1	6.5 ⁽¹⁾	10 ⁽¹⁾	A
Power Rating	4	2015 ⁽²⁾	4000 ⁽²⁾	Watts
Switching Frequency	0	—	20	kHz

Note 1: The system continuously operated during one hour, 15 kHz switching frequency and the PFC boost circuit disabled.

- 2:** It is possible to increase the available maximum output power up to 4000W by using an external ventilation mechanism attached to system near to the power module. To provide additional air flow, a conventional AC muffin fan can be used (Comair-rottron part number 028021 or 028023). An alternative bonded fin heat sink with fans attached is also an option (C&H Technology, Inc. part number CH5117F).

TABLE 4-10: PFC ELECTRICAL SPECIFICATIONS

Parameter	Min	Typ	Max	Units
DC Bus	90	380	400	V _{DC}
Current	0.1	2.6 ⁽¹⁾	3.5 ⁽¹⁾	A
Power Rating	9	1000 ⁽²⁾	1400 ⁽²⁾	Watts
Switching Frequency	0	50	100	kHz

Note 1: The system continuously operated during one hour, 50 kHz switching frequency.

- 2:** It is possible to increase the available maximum output power up to 1400W by using an external ventilation mechanism attached to system near to the PFC IGBT. To provide additional air flow, a conventional AC muffin fan can be used (Comair-rottron part number 028021 or 028023). An alternative bonded fin heat sink with fans attached is also an option (C&H Technology, Inc. part number CH5117F).

dsPICDEM™ MCHV Development System User's Guide

NOTES:

Appendix A. Board Layout and Schematics

FIGURE A-1: PFC STAGE BOARD LAYOUT (TOP)

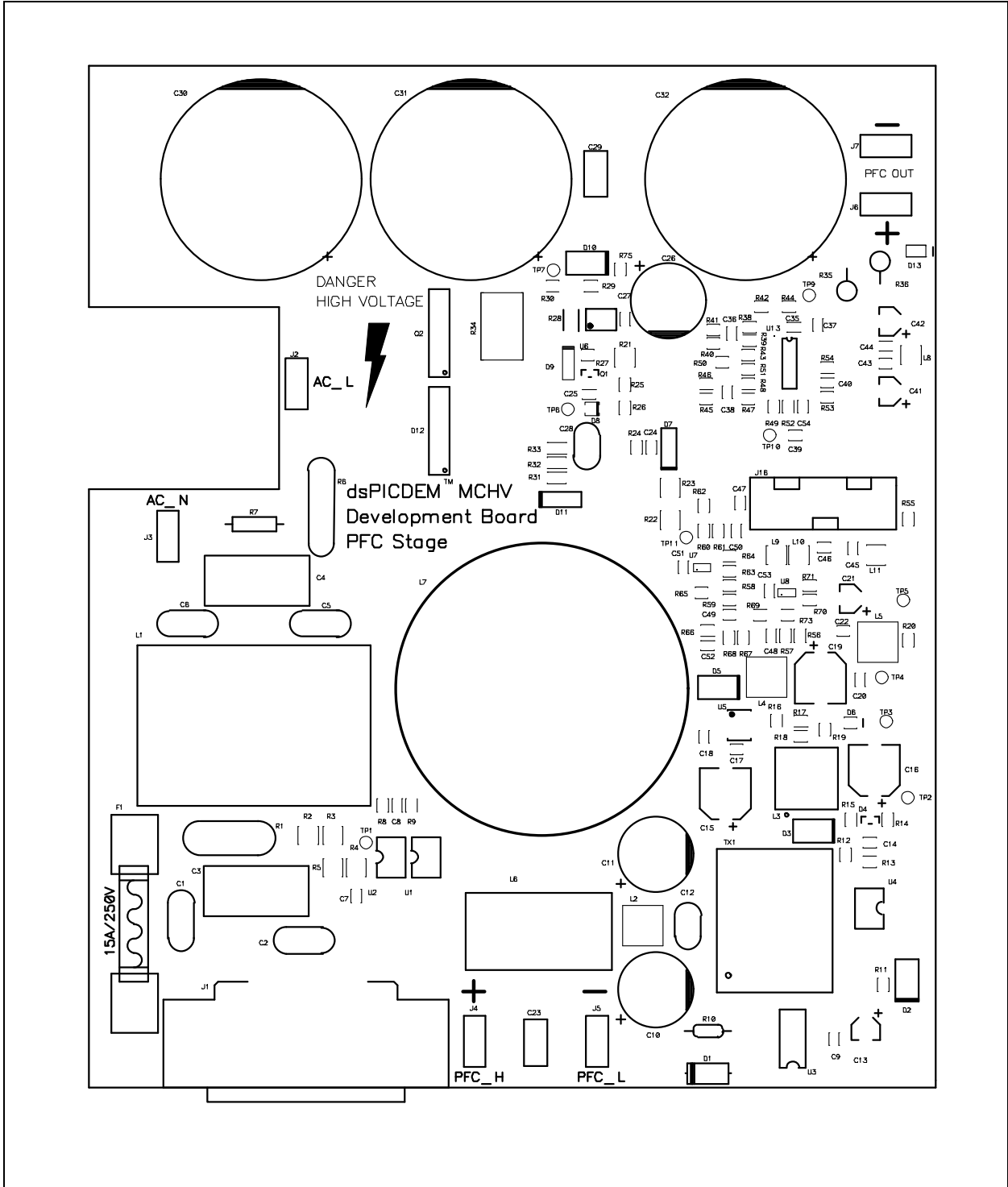
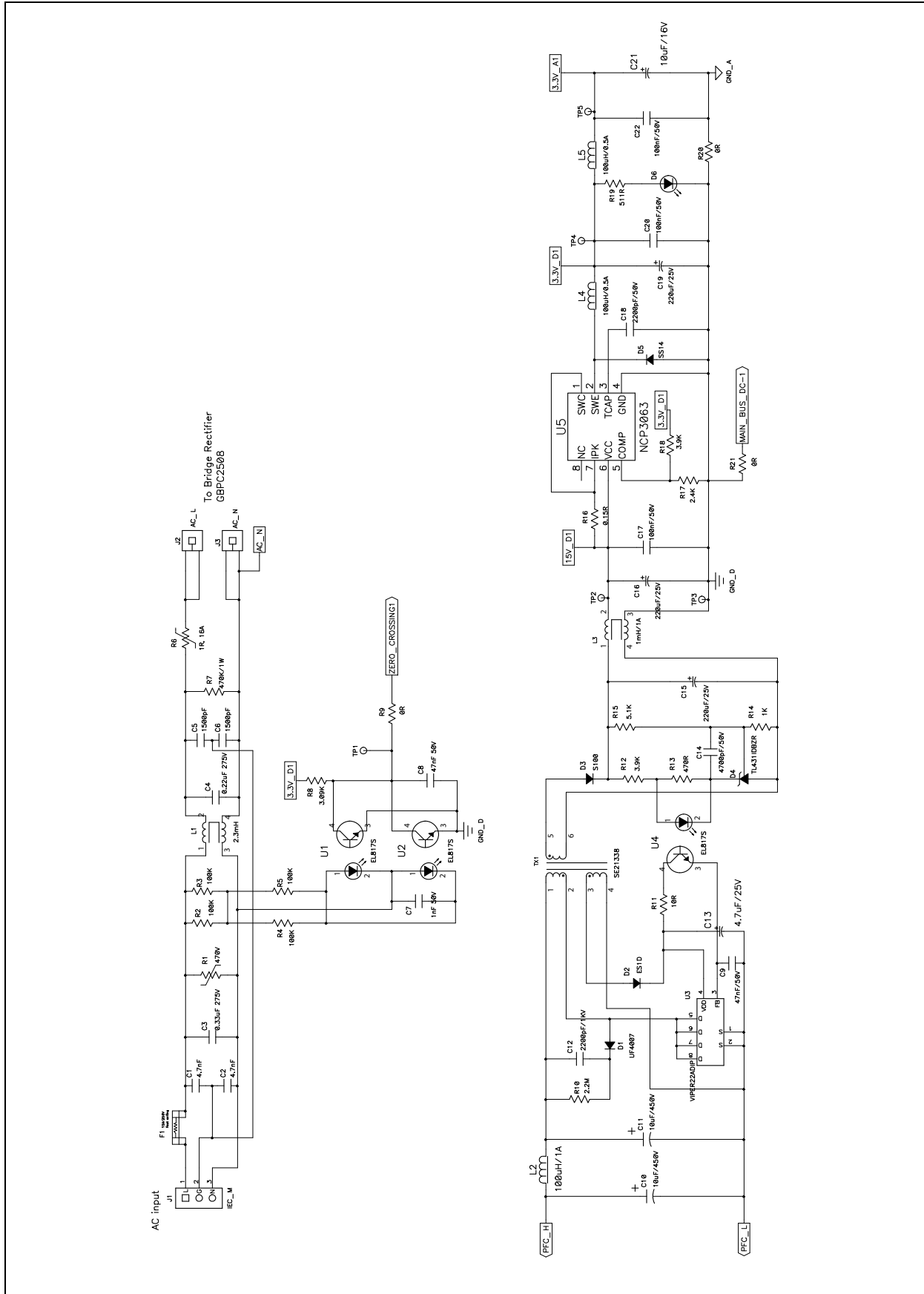

FIGURE A-2: PFC STAGE SCHEMATIC (SHEET 1 OF 3)



Board Layout and Schematics

FIGURE A-3: PFC STAGE SCHEMATIC (SHEET 2 OF 3)

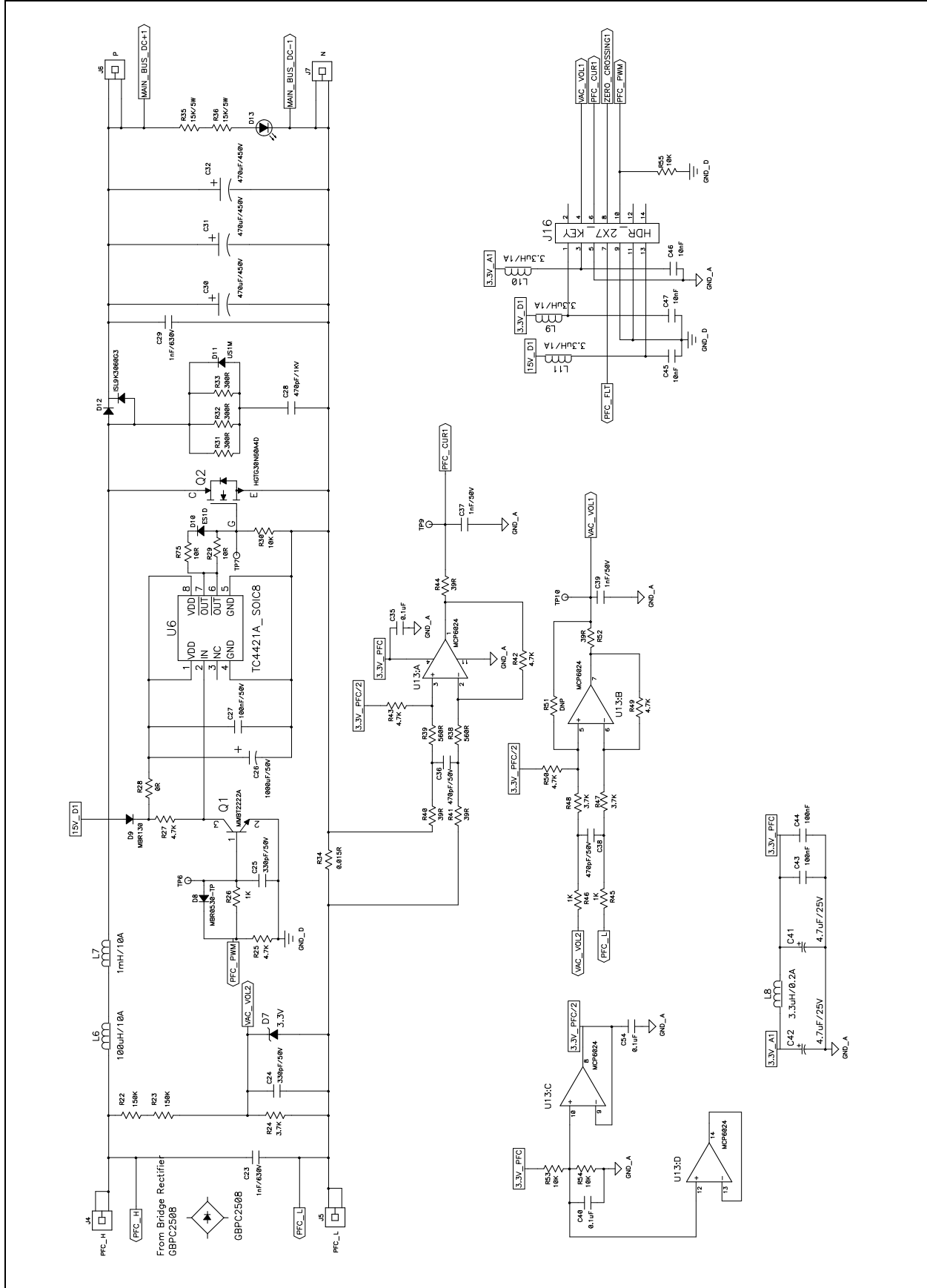

FIGURE A-4: PFC STAGE SCHEMATIC (SHEET 3 OF 3)

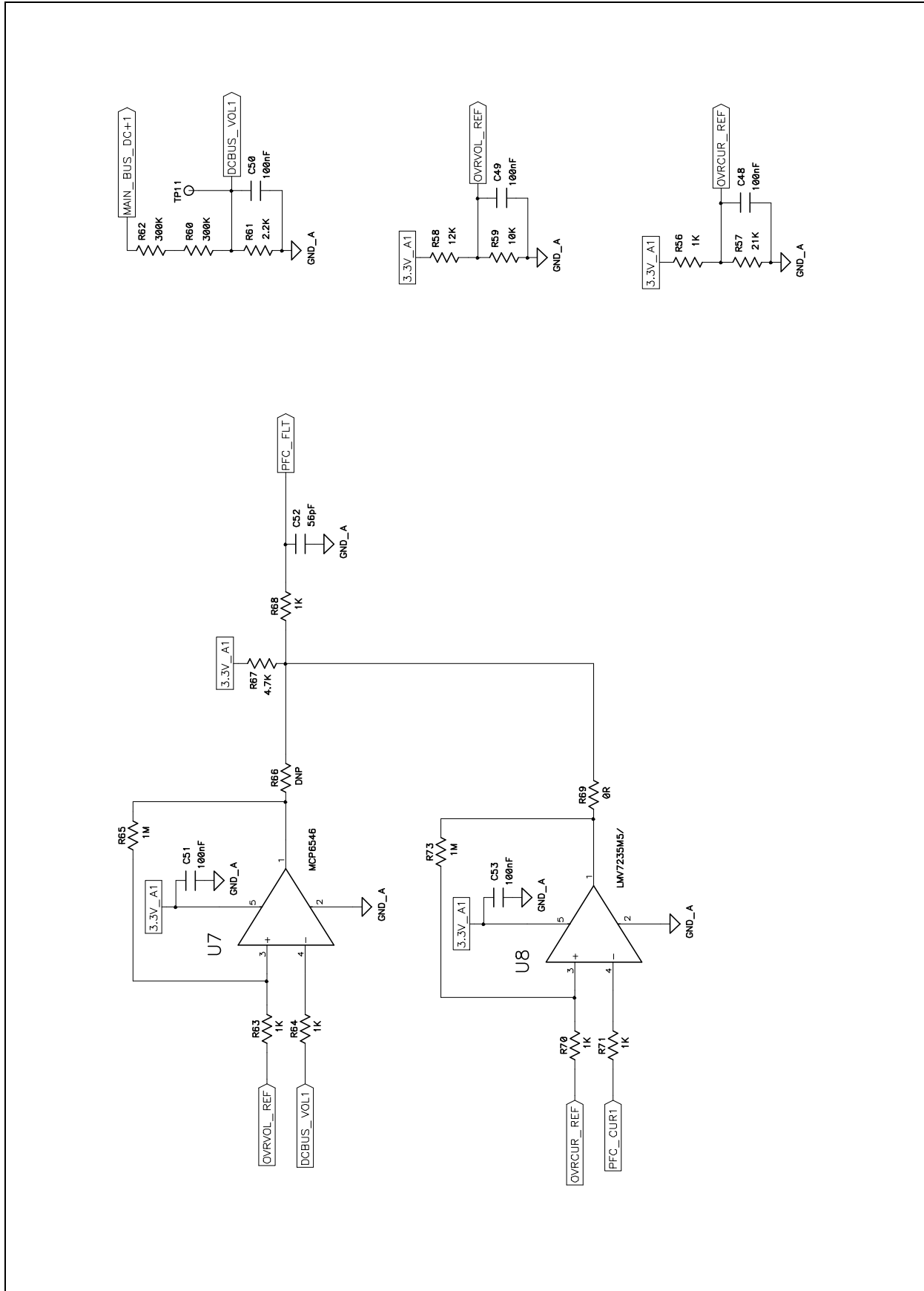

FIGURE A-5: POWER MODULE STAGE BOARD LAYOUT (TOP)

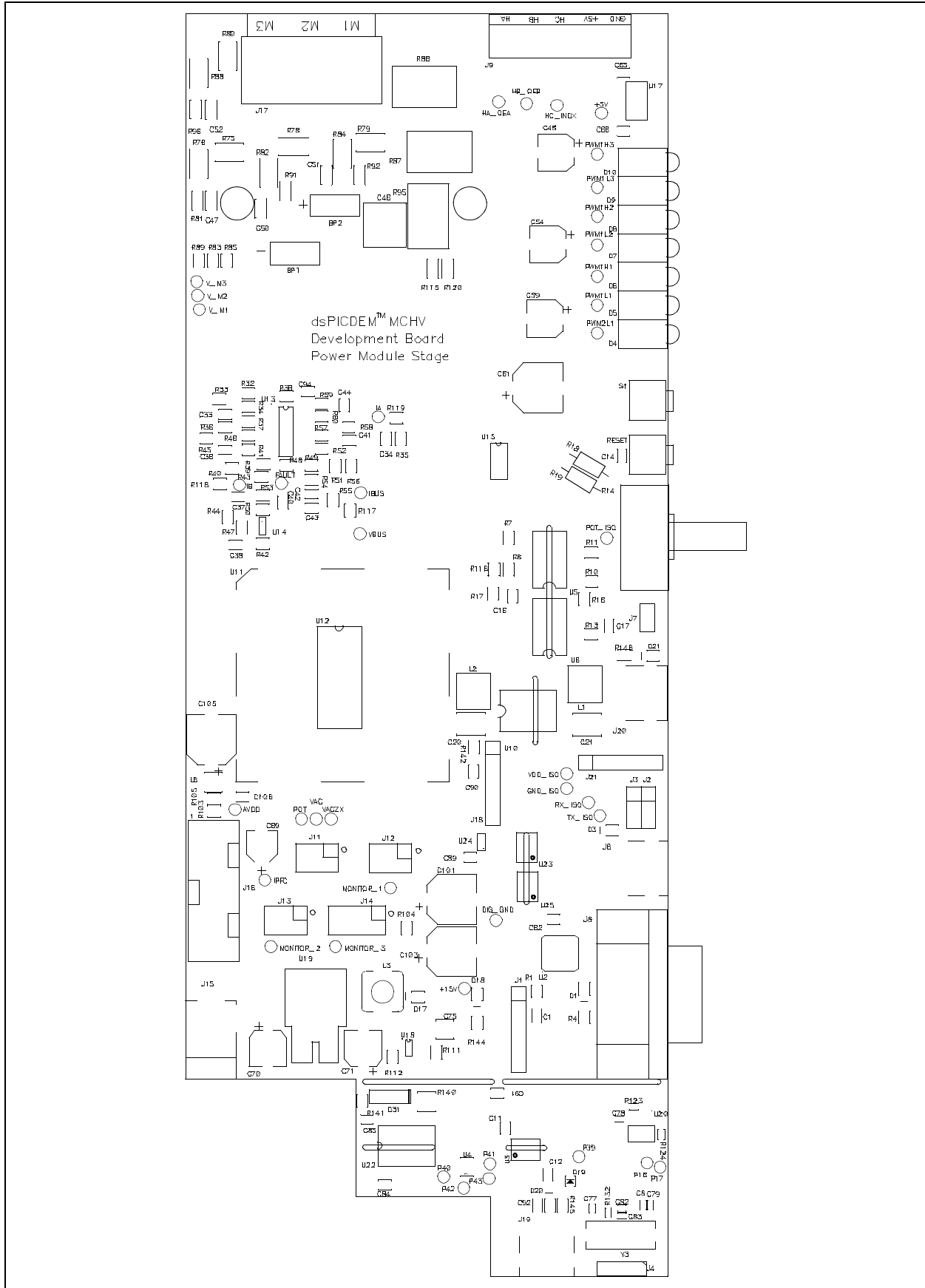

FIGURE A-6: POWER MODULE STAGE BOARD LAYOUT (BOTTOM)

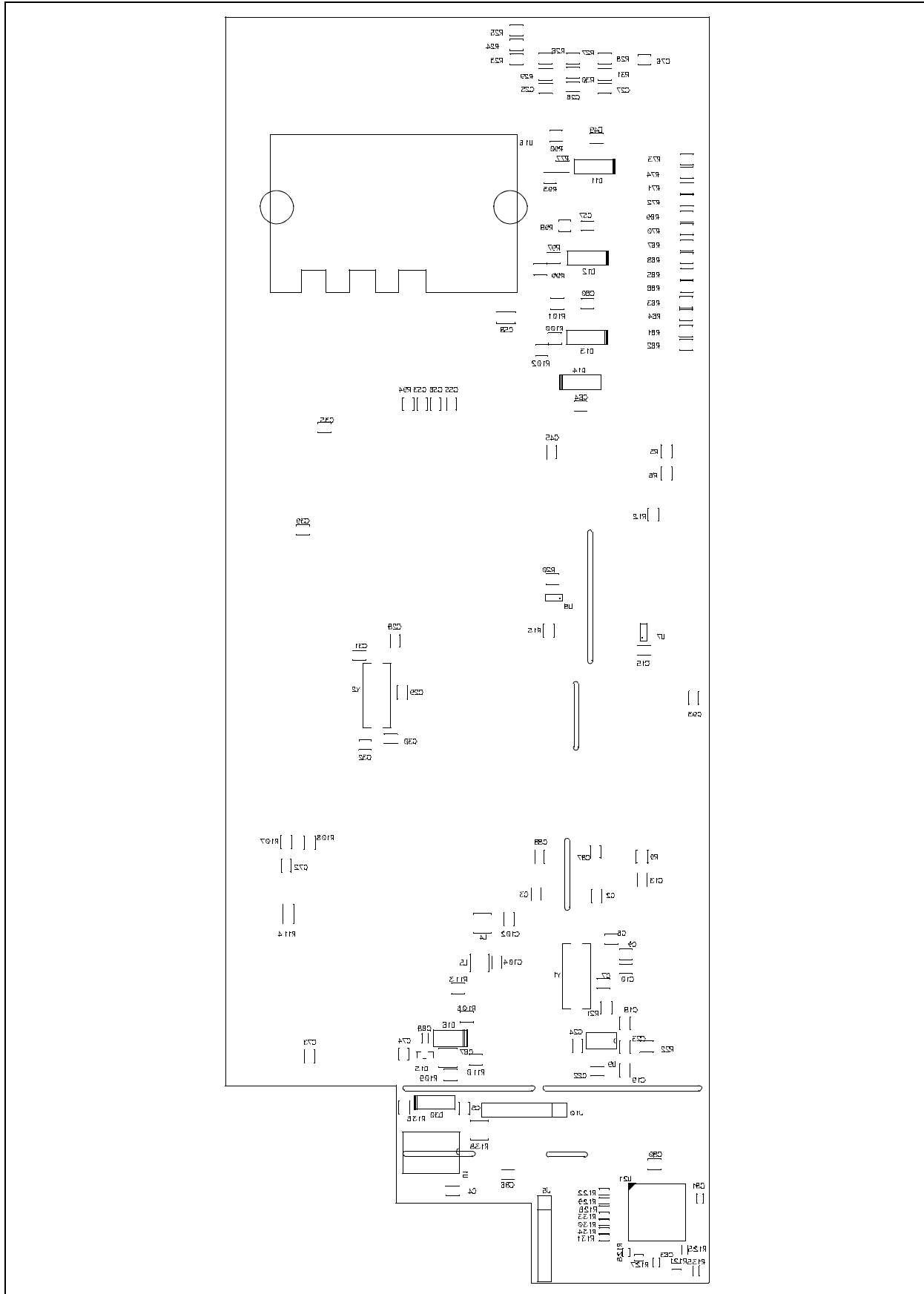

FIGURE A-8: POWER MODULE STAGE SCHEMATIC (SHEET 2 OF 6)

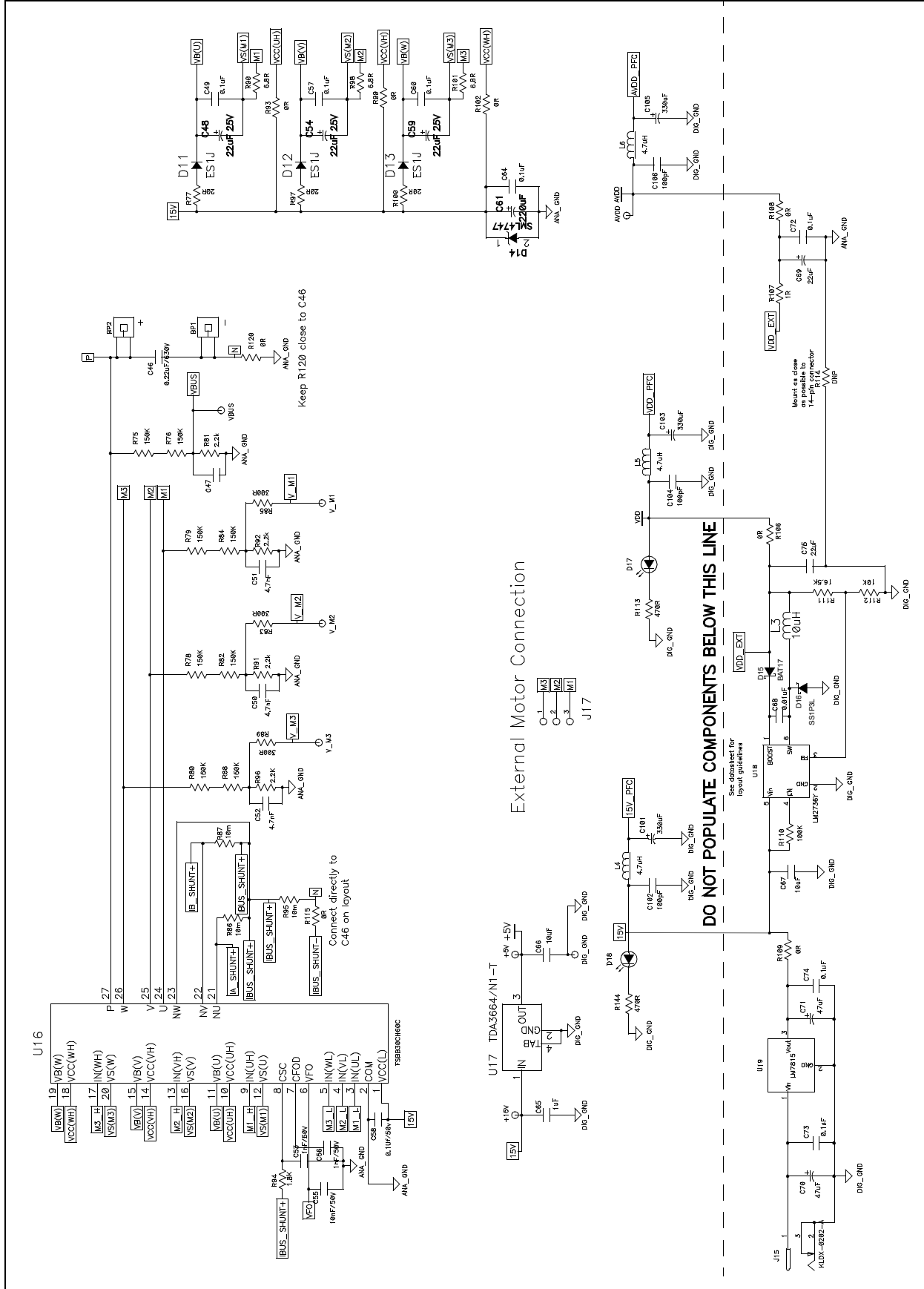

FIGURE A-9: POWER MODULE STAGE SCHEMATIC (SHEET 3 OF 6)

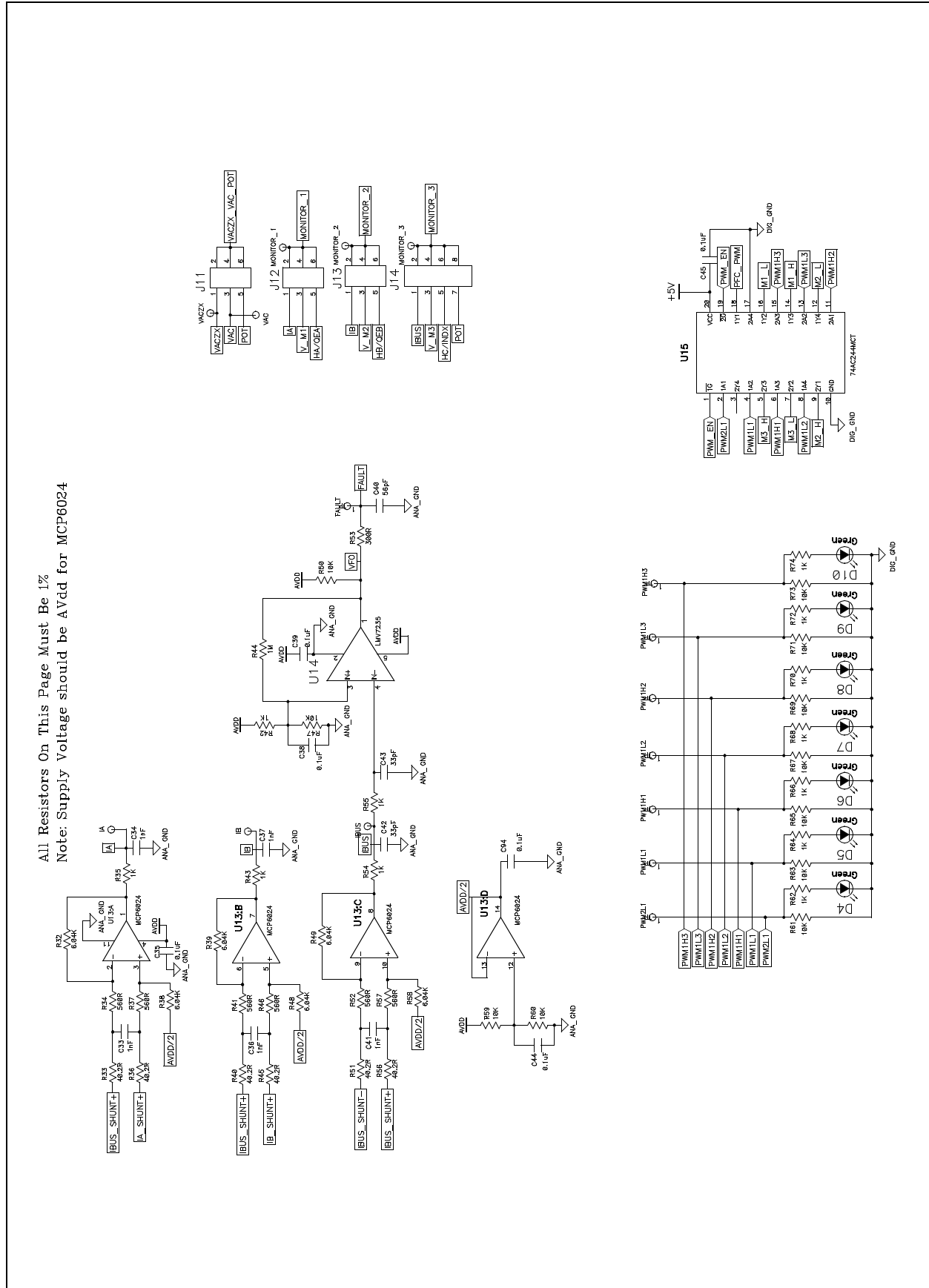

FIGURE A-10: POWER MODULE STAGE SCHEMATIC (SHEET 4 OF 6)

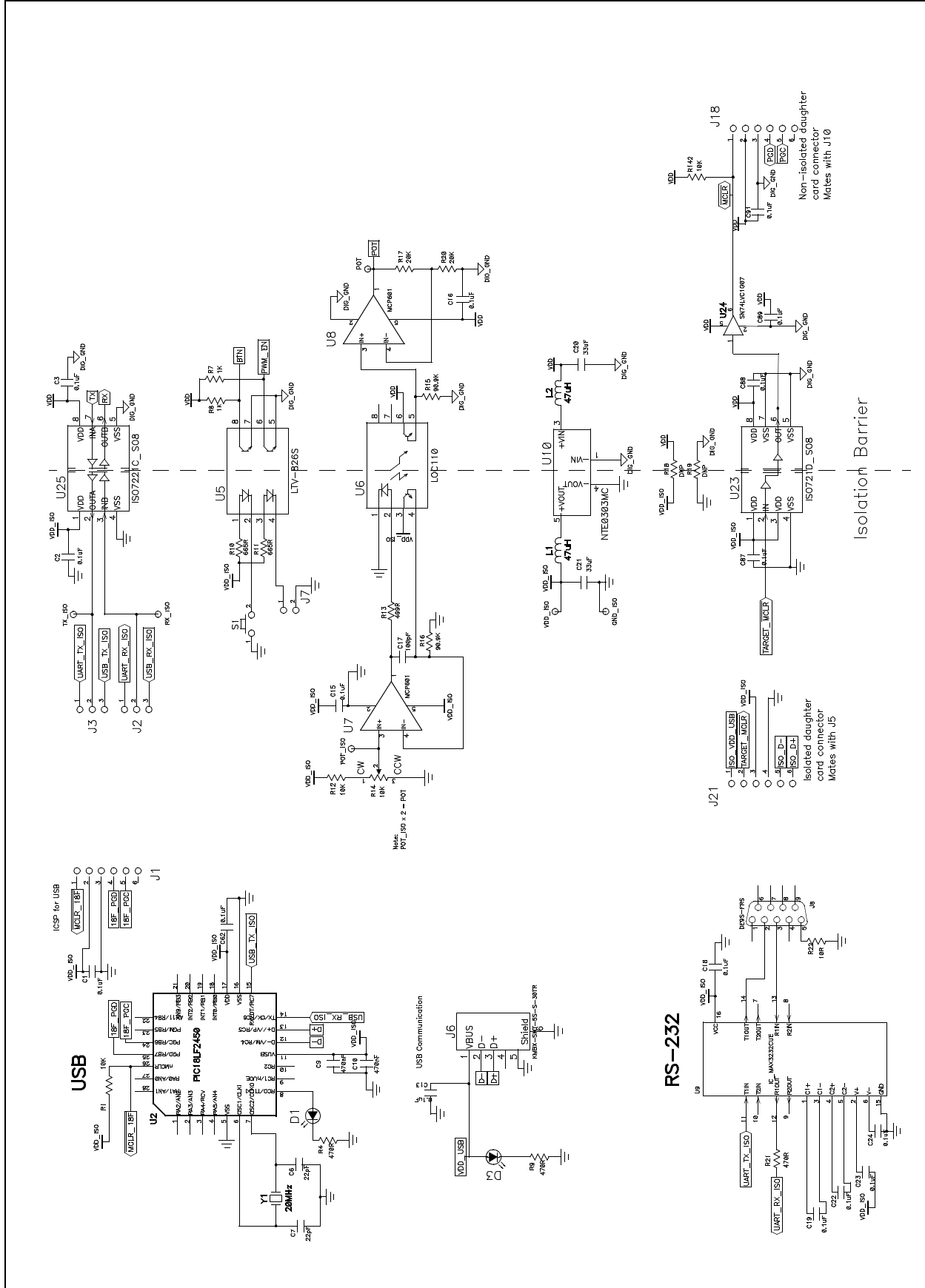
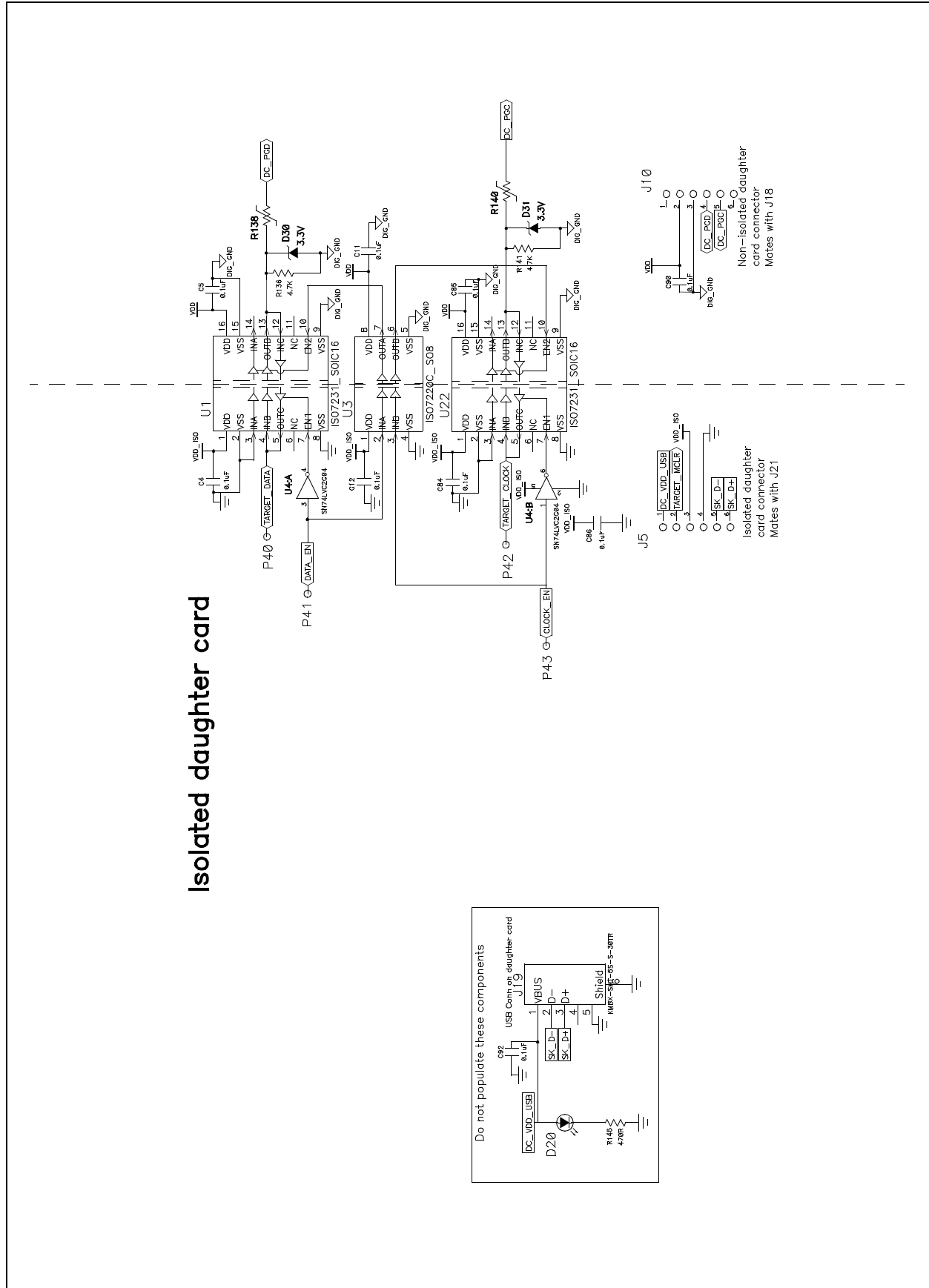

FIGURE A-11: POWER MODULE STAGE SCHEMATIC (SHEET 5 OF 6)





dsPICDEM™ MCHV DEVELOPMENT SYSTEM USER'S GUIDE

Index

A	
Application Debug Setup	19
Application Debugging	22
Application Programming	24
C	
Communication Port Connectors	17
Connection Sequence	17
Customer Notification Service	4
Customer Support	5
D	
DC BUS Current Feedback	38
DC BUS Overcurrent	39
DC BUS Voltage Feedback	38
Demonstration Software	27
Documentation	
Conventions	2
Layout	1
dsPICDEM™ MCHV Development System	
Features	10
Overview	7
System Block Diagram	9
H	
Hall Sensors	38
Hardware Components	29
I	
Interface Components	14
Internet Address	4
Inverter Leg Shunt Resistor Feedback	38
M	
Microchip Internet Web Site	4
P	
PFC Stage	13, 29
Phase Voltage Feedback	38
PIM Configuration	33
Power Connections	15, 17
Power Module	37
Power Module Stage	13, 33
Power Supplies	37
Power-down Sequence	19
Power-up Sequence	19
Programming and Debugging	19
Programming Problems	25
R	
Reading, Recommended	3
Running the Starter Kit Application	21
S	
Safety Notice	iii
System Connections	16
T	
Troubleshooting	25
U	
Using Breakpoints and Mouseovers	23
Using Watch Windows	24
W	
Warranty Registration	3
WWW Address	4



Worldwide Sales and Service

AMERICAS

Corporate Office
2355 West Chandler Blvd.
Chandler, AZ 85224-6199
Tel: 480-792-7200
Fax: 480-792-7277
Technical Support:
<http://support.microchip.com>
Web Address:
www.microchip.com

Atlanta
Duluth, GA
Tel: 678-957-9614
Fax: 678-957-1455

Boston
Westborough, MA
Tel: 774-760-0087
Fax: 774-760-0088

Chicago
Itasca, IL
Tel: 630-285-0071
Fax: 630-285-0075

Cleveland
Independence, OH
Tel: 216-447-0464
Fax: 216-447-0643

Dallas
Addison, TX
Tel: 972-818-7423
Fax: 972-818-2924

Detroit
Farmington Hills, MI
Tel: 248-538-2250
Fax: 248-538-2260

Kokomo
Kokomo, IN
Tel: 765-864-8360
Fax: 765-864-8387

Los Angeles
Mission Viejo, CA
Tel: 949-462-9523
Fax: 949-462-9608

Santa Clara
Santa Clara, CA
Tel: 408-961-6444
Fax: 408-961-6445

Toronto
Mississauga, Ontario,
Canada
Tel: 905-673-0699
Fax: 905-673-6509

ASIA/PACIFIC

Asia Pacific Office
Suites 3707-14, 37th Floor
Tower 6, The Gateway
Harbour City, Kowloon
Hong Kong
Tel: 852-2401-1200
Fax: 852-2401-3431

Australia - Sydney
Tel: 61-2-9868-6733
Fax: 61-2-9868-6755

China - Beijing
Tel: 86-10-8528-2100
Fax: 86-10-8528-2104

China - Chengdu
Tel: 86-28-8665-5511
Fax: 86-28-8665-7889

China - Hong Kong SAR
Tel: 852-2401-1200
Fax: 852-2401-3431

China - Nanjing
Tel: 86-25-8473-2460
Fax: 86-25-8473-2470

China - Qingdao
Tel: 86-532-8502-7355
Fax: 86-532-8502-7205

China - Shanghai
Tel: 86-21-5407-5533
Fax: 86-21-5407-5066

China - Shenyang
Tel: 86-24-2334-2829
Fax: 86-24-2334-2393

China - Shenzhen
Tel: 86-755-8203-2660
Fax: 86-755-8203-1760

China - Wuhan
Tel: 86-27-5980-5300
Fax: 86-27-5980-5118

China - Xiamen
Tel: 86-592-2388138
Fax: 86-592-2388130

China - Xian
Tel: 86-29-8833-7252
Fax: 86-29-8833-7256

China - Zhuhai
Tel: 86-756-3210040
Fax: 86-756-3210049

ASIA/PACIFIC

India - Bangalore
Tel: 91-80-3090-4444
Fax: 91-80-3090-4080

India - New Delhi
Tel: 91-11-4160-8631
Fax: 91-11-4160-8632

India - Pune
Tel: 91-20-2566-1512
Fax: 91-20-2566-1513

Japan - Yokohama
Tel: 81-45-471- 6166
Fax: 81-45-471-6122

Korea - Daegu
Tel: 82-53-744-4301
Fax: 82-53-744-4302

Korea - Seoul
Tel: 82-2-554-7200
Fax: 82-2-558-5932 or
82-2-558-5934

Malaysia - Kuala Lumpur
Tel: 60-3-6201-9857
Fax: 60-3-6201-9859

Malaysia - Penang
Tel: 60-4-227-8870
Fax: 60-4-227-4068

Philippines - Manila
Tel: 63-2-634-9065
Fax: 63-2-634-9069

Singapore
Tel: 65-6334-8870
Fax: 65-6334-8850

Taiwan - Hsin Chu
Tel: 886-3-6578-300
Fax: 886-3-6578-370

Taiwan - Kaohsiung
Tel: 886-7-536-4818
Fax: 886-7-536-4803

Taiwan - Taipei
Tel: 886-2-2500-6610
Fax: 886-2-2508-0102

Thailand - Bangkok
Tel: 66-2-694-1351
Fax: 66-2-694-1350

EUROPE

Austria - Wels
Tel: 43-7242-2244-39
Fax: 43-7242-2244-393

Denmark - Copenhagen
Tel: 45-4450-2828
Fax: 45-4485-2829

France - Paris
Tel: 33-1-69-53-63-20
Fax: 33-1-69-30-90-79

Germany - Munich
Tel: 49-89-627-144-0
Fax: 49-89-627-144-44

Italy - Milan
Tel: 39-0331-742611
Fax: 39-0331-466781

Netherlands - Drunen
Tel: 31-416-690399
Fax: 31-416-690340

Spain - Madrid
Tel: 34-91-708-08-90
Fax: 34-91-708-08-91

UK - Wokingham
Tel: 44-118-921-5869
Fax: 44-118-921-5820