

SR520 THRU SR5100

List

深圳FMS Kinter 131 6803 0058

| | |
|---|---|
| List..... | 1 |
| Package outline..... | 2 |
| Features..... | 2 |
| Mechanical data..... | 2 |
| Maximum ratings | 2 |
| Rating and characteristic curves..... | 3 |
| Pinning information..... | 4 |
| Marking..... | 4 |
| Taping & bulk specifications for AXIAL devices..... | 4 |
| Suggested thermal profiles for soldering processes..... | 5 |
| High reliability test capabilities..... | 6 |

SR520 THRU SR5100

5.0A Axial Leaded Schottky Barrier Rectifiers - 20V-100V

Features

- Axial lead type devices for through hole design
- Low power loss, high efficiency.
- High current capability, low forward voltage drop.
- High surge capability.
- Guardring for overvoltage protection.
- Ultra high-speed switching.
- Silicon epitaxial planar chip, metal silicon junction.
- Lead-free parts meet environmental standards of MIL-STD-19500 /228
- Suffix "-H" for Halogen-free part, ex.SR520-H

Mechanical data

- Epoxy : UL94-V0 rated flame retardant
- Case : Molded plastic, DO-201AD
- Lead : Axial leads, solderable per MIL-STD-202, Method 208 guaranteed
- Polarity: Color band denotes cathode end
- Mounting Position : Any
- Weight : Approximated 1.10 gram

Package outline

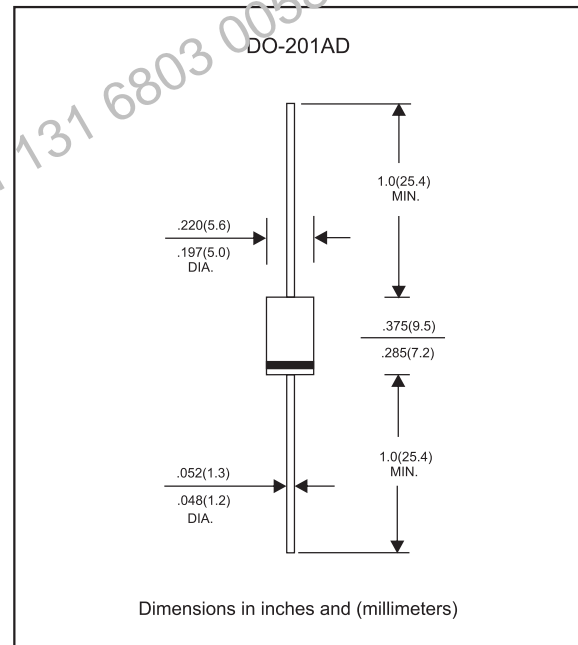

Maximum ratings and Electrical Characteristics (AT $T_A=25^\circ\text{C}$ unless otherwise noted)

| PARAMETER | CONDITIONS | Symbol | MIN. | TYP. | MAX. | UNIT |
|----------------------------|---|-----------------|------|------|------|---------------------------|
| Forward rectified current | See Fig.2 | I_o | | | 5.0 | A |
| Forward surge current | 8.3ms single half sine-wave superimposed on rate load (JEDEC methode) | I_{FSM} | | | 150 | A |
| Reverse current | $V_R = V_{RRM} \quad T_J = 25^\circ\text{C}$ | I_R | | | 0.5 | mA |
| | $V_R = V_{RRM} \quad T_J = 100^\circ\text{C}$ | | | | 50 | |
| Thermal resistance | Junction to ambient | $R_{\theta JA}$ | | 10 | | $^\circ\text{C}/\text{W}$ |
| Diode junction capacitance | $f=1\text{MHz}$ and applied 4V DC reverse voltage | C_J | | 380 | | pF |
| Storage temperature | | T_{STG} | -65 | | +175 | $^\circ\text{C}$ |

| SYMBOLS | V_{RRM}^{*1} (V) | V_{RMS}^{*2} (V) | V_R^{*3} (V) | V_F^{*4} (V) | Operating temperature $T_J, (^\circ\text{C})$ |
|---------|-----------------------|-----------------------|-------------------|-------------------|--|
| SR520 | 20 | 14 | 20 | 0.55 | -55 to +125 |
| SR530 | 30 | 21 | 30 | | |
| SR540 | 40 | 28 | 40 | | |
| SR550 | 50 | 35 | 50 | 0.70 | -55 to +150 |
| SR560 | 60 | 42 | 60 | | |
| SR580 | 80 | 56 | 80 | | |
| SR5100 | 100 | 70 | 100 | 0.85 | |

*1 Repetitive peak reverse voltage

*2 RMS voltage

*3 Continuous reverse voltage

*4 Maximum forward voltage @ $I_F=5.0\text{A}$

Rating and characteristic curves (SR520 THRU SR5100)

FIG.1-TYPICAL FORWARD CURRENT DERATING CURVE

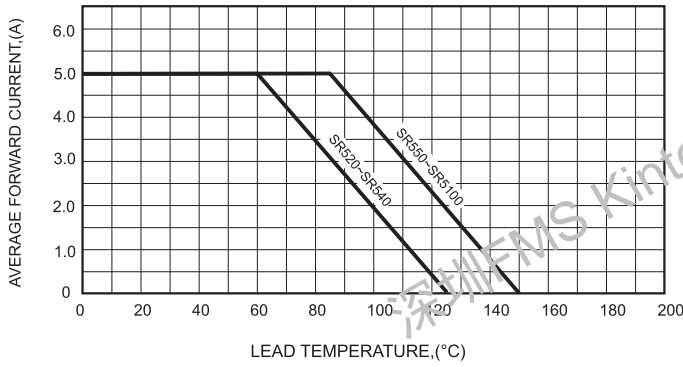

FIG.2-TYPICAL FORWARD CHARACTERISTICS

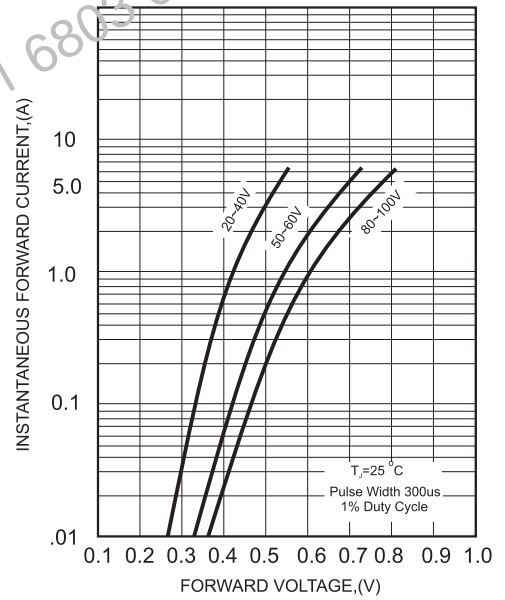

FIG.3-MAXIMUM NON-REPETITIVE FORWARD SURGE CURRENT

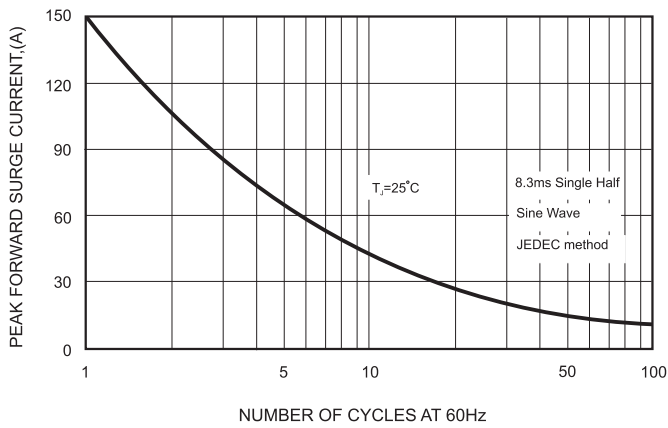

FIG.5 - TYPICAL REVERSE CHARACTERISTICS

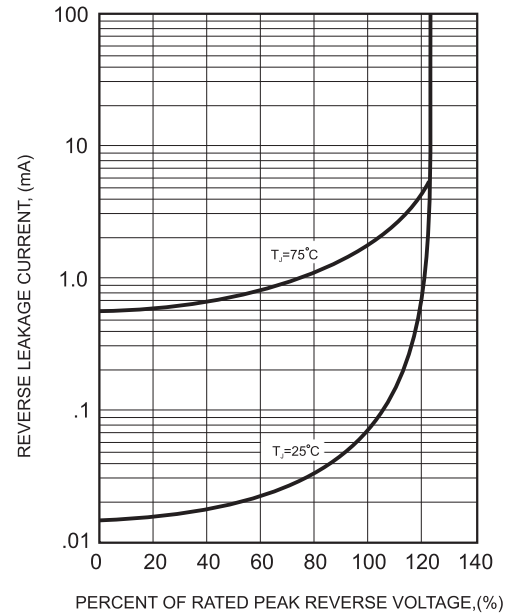
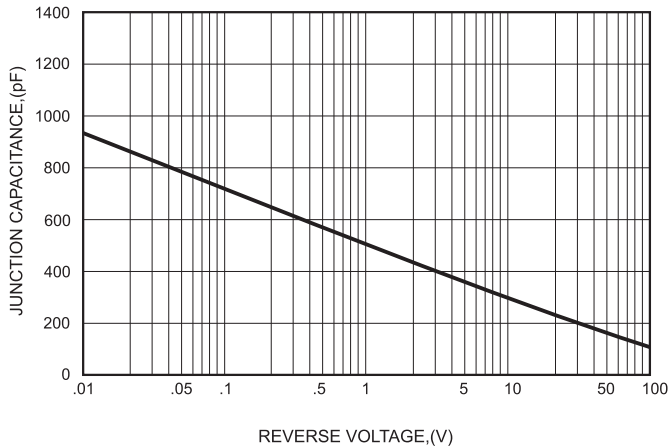



FIG.4-TYPICAL JUNCTION CAPACITANCE



SR520 THRU SR5100

Pinning information

| Pin | Simplified outline | Symbol |
|----------------------------|--|---|
| Pin1 cathode Pin2 anode |  |  |

Marking

| Type number | Marking code |
|-------------|--------------|
| SR520 | SR520 |
| SR530 | SR530 |
| SR540 | SR540 |
| SR550 | SR550 |
| SR560 | SR560 |
| SR580 | SR580 |
| SR5100 | SR5100 |

Taping & bulk specifications for AXIAL devices

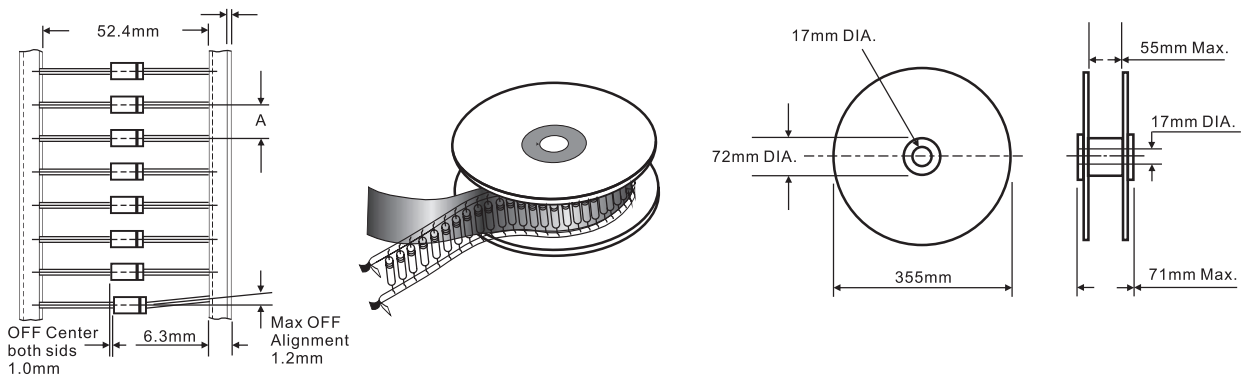

REEL PACKING

| DEVICE CASE TYPE | Q'TY 1 (PCS / REEL) | COMPONENT SPACING "A" in FIG. A | CARTON SIZE (m/m) | Q'TY 2 (PCS / CARTON) | APPROX. CROSS WEIGHT(kg) |
|------------------|---------------------|---------------------------------|-------------------|-----------------------|--------------------------|
| DO-201AD | 1,200 | 10 mm | 380 * 340 * 370 | 4,800 | 9.1 |

AMMO PACKING

| DEVICE CASE TYPE | Q'TY 1 (PCS / BOX) | INNER BOX SIZE (m/m) | CARTON SIZE (m/m) | Q'TY 2 (PCS / CARTON) | APPROX. CROSS WEIGHT(kg) |
|------------------|--------------------|----------------------|-------------------|-----------------------|--------------------------|
| DO-201AD | 1,200 | 260 * 83 * 160 | 440 * 270 * 340 | 12,000 | 17.0 |

SR520 THRU SR5100

BULK PACKING

| DEVICE CASE TYPE | Q'TY 1 (PCS / BOX) | INNER BOX SIZE (m/m) | CARTON SIZE (m/m) | Q'TY 2 (PCS / CARTON) | APPROX. CROSS WEIGHT(kg) |
|------------------|--------------------|----------------------|-------------------|-----------------------|--------------------------|
| DO-201AD | 500 | 305 * 73 * 40 | 347 * 320 * 271 | 12,000 | 16.4 |

Suggested thermal profiles for soldering processes

1. Lead free temperature profile wave-soldering

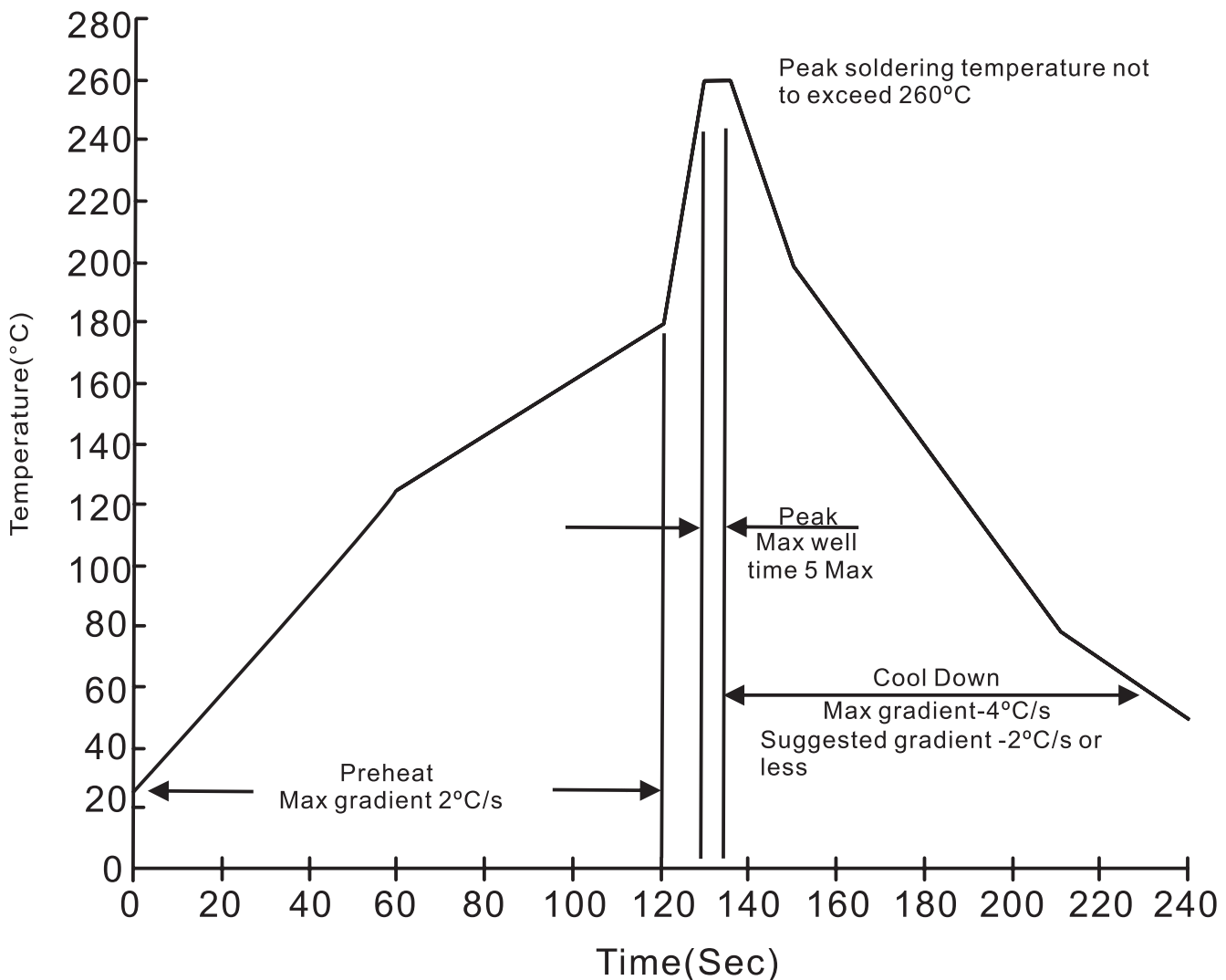

SR520 THRU SR5100**High reliability test capabilities**

| Item Test | Conditions | Reference |
|-----------------------------------|--|-------------------------------|
| 1. Solder Resistance | at $260\pm 5^{\circ}\text{C}$ for $10\pm 2\text{sec}$. immerse body into solder $1/16''\pm 1/32''$ | MIL-STD-750D METHOD-2031 |
| 2. Solderability | at $245\pm 5^{\circ}\text{C}$ for 5 sec. | MIL-STD-202F METHOD-208 |
| 3. Pull Test | 2kg in axial lead direction for 10 sec. | MIL-STD-750D METHOD-2036 |
| 4. Bend Lead | 2kg weight applied to each lead bending arc $90^{\circ}\pm 5^{\circ}$ for 3 times. | MIL-STD-750D METHOD-2036 |
| 5. High Temperature Reverse Bias | $V_R=80\%$ rate at $T_j=125^{\circ}\text{C}$ for 168 hrs. | MIL-STD-750D METHOD-1038 |
| 6. Forward Operation Life | Rated average rectifier current at $T_A=25^{\circ}\text{C}$ for 500hrs. | MIL-STD-750D METHOD-1027 |
| 7. Intermittent Operation Life | $T_A = 25^{\circ}\text{C}$, $I_F = I_o$ On state: power on for 5 min. off state: power off for 5 min, on and off for 500 cycles. | MIL-STD-750D METHOD-1036 |
| 8. Pressure Cooker | $15P_{SIG}$ at $T_A=121^{\circ}\text{C}$ for 4 hrs. | JESD22-A102 |
| 9. Temperature Cycling | -55°C to $+125^{\circ}\text{C}$ dwelled for 30 min. and transferred for 5min. total 10 cycles. | MIL-STD-750D METHOD-1051 |
| 10. Thermal Shock | 0°C for 5 min. rise to 100°C for 5 min. total 10 cycles. | MIL-STD-750D METHOD-1056 |
| 11. Forward Surge | 8.3ms single half sine-wave superimposed on rated load, one surge. | MIL-STD-750D METHOD-4066-2 |
| 12. Humidity | at $T_A=85^{\circ}\text{C}$, RH=85% for 1000hrs. | MIL-STD-750D METHOD-1021 |
| 13. High Temperature Storage Life | at 175°C for 1000 hrs. | MIL-STD-750D METHOD-1031 |