

DESCRIPTION

The MP24892 is a high-efficiency step-down converter that functions in continuous current mode to drive high-brightness LED. It can take a wide input voltage range of 6V–45V.

The MP24892 employs a hysteretic control architecture to regulate a high-accuracy LED current, which is measured through an external high-side current-sensing resistor. Moreover, this control scheme provides optimal circuit stabilization and a very quick response time without loop compensation. Its low 202mV average feedback voltage reduces power loss and improves the converter efficiency.

The MP24892 implements PWM and analog dimming together through the DIM pin.

The MP24892 includes thermal overload protection that prevents damage in the event of an output overload.

The MP24892 is available in a small TSOT23-5 package.

FEATURES

- Wide 6V-to-45V Input Range
- 1A Output Current
- High Efficiency (>95%)
- Hysteresis Control
- PWM & Analog Dimming
- 1000:1 PWM Dimming Resolution
- Thermal Shutdown
- Inherent Open LED Protection
- Short LED Protection
- Available in a TSOT23-5 Package

APPLICATIONS

- Low-Voltage Halogen Replacement
- Low-Voltage General Illumination
- Automotive/Decorative LED Lighting
- Signs/Emergency Lighting
- LED Backlighting

All MPS parts are lead-free and adhere to the RoHS directive. For MPS green status, please visit MPS website under the Products, Quality Assurance page.

"MPS" and "The Future of Analog IC Technology" are Registered Trademarks of Monolithic Power Systems, Inc.

TYPICAL APPLICATION

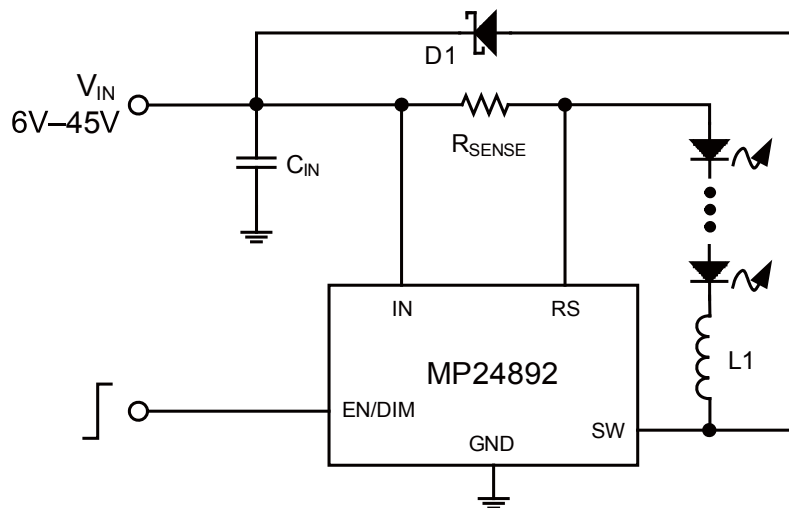

ORDERING INFORMATION

Part Number	Package	Top Marking
MP24892DJ*	TSOT23-5	ABHY

* For Tape & Reel, add suffix -Z (e.g. MP24892DJ-Z);

PACKAGE REFERENCE

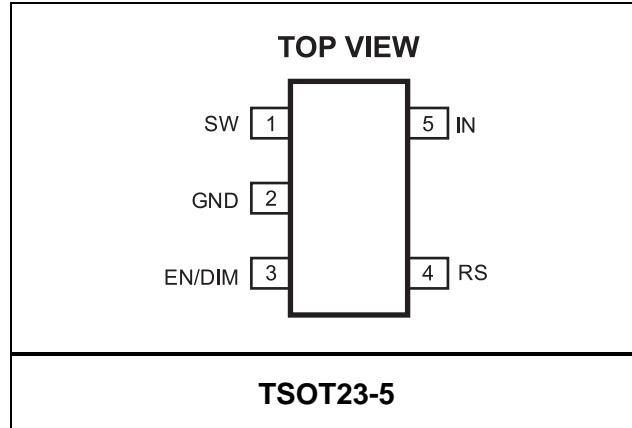

ABSOLUTE MAXIMUM RATINGS ⁽¹⁾

V_{IN}, V_{SW}	-0.3V to +50V
V_{RS}	$V_{IN}-5V$ to V_{IN}
All Other Pins	-0.3V to +6.3V
Continuous Power Dissipation ($T_A = +25^\circ C$) ⁽²⁾	
TSOT23-5	1.25W
Junction Temperature	150°C
Lead Temperature	260°C
Storage Temperature	-65°C to +150°C

Recommended Operating Conditions ⁽³⁾

Supply Voltage V_{IN}	6V to 45V
Maximum Junction Temp. (T_J)	-40°C to +125°C

Thermal Resistance ⁽⁴⁾

	θ_{JA}	θ_{JC}
TSOT23-5	100	55 ... °C/W

Notes:

- Exceeding these ratings may damage the device.
- The maximum allowable power dissipation is a function of the maximum junction temperature $T_J(MAX)$, the junction-to-ambient thermal resistance θ_{JA} , and the ambient temperature T_A . The maximum allowable continuous power dissipation at any ambient temperature is calculated by $P_D(MAX) = (T_J(MAX) - T_A) / \theta_{JA}$. Exceeding the maximum allowable power dissipation will cause excessive die temperature, and the regulator will go into thermal shutdown. Internal thermal shutdown circuitry protects the device from permanent damage.
- The device is not guaranteed to function outside of its operation conditions.
- Measured on JESD51-7, 4-layer PCB.

ELECTRICAL CHARACTERISTICS

$V_{IN} = 24V$, $T_A = +25^{\circ}C$, unless otherwise noted.

Parameter	Symbol	Condition	Min	Typ	Max	Units
Input Voltage	V_{IN}		6		45	V
Shutdown Supply Current	I_{SD}				108	μA
Quiescent Supply Current	I_Q	No Switching			1	mA
Internal Reference Voltage	I_{REF}			1.275		V
Feedback Reference Voltage (with respect to V_{IN})	$V_{IN}-V_{RS}$	$V_{EN/DIM} = 1.28V$	192	202	212	mV
Feedback Reference Voltage Hysteresis	V_{FB_HYS}			± 30		mV
EN/DIM Max. Dimming Voltage	V_{DIM_MAX}				2.56	V
EN/DIM Mim. Dimming Voltage	V_{DIM_MIN}		0.3			V
EN/DIM Enable High Voltage	V_{EN_HIGH}	V_{EN} Rising		0.25	0.3	V
EN/DIM Enable Hysteresis	V_{EN_HYS}		20	50	80	mV
EN/DIM Pull-Up Resistor	R_{EN}			45		k Ω
Recommended PWM Dimming Frequency	f_{PWM}		0.1		2	kHz
Switch On Resistance	R_{DS_ON}			0.5		Ω
Minimum On Time	t_{ON_MIN}			100		ns
Minimum Off Time	t_{OFF_MIN}			100		ns
Recommended Maximum Operating Frequency	f_{MAX}				600	kHz
Recommended Duty Cycle Range at f_{MAX}	D		30		70	%
Start-Up Time	t_{SS}	External capacitor on dim pin is 4.7nF		0.3		ms

PIN FUNCTIONS

TSOT23-5 Pin#	Name	Description
1	SW	Internal MOSFET Drain. Connecting the common terminal of inductor and anode of Schottky to this pin.
2	GND	Ground.
3	EN/DIM	Enable/Dimming. Apply a square wave signal for PWM dimming (refer to application information). Apply a 0.3V–2.5V DC voltage for analog dimming. The DC voltage linearly controls the LED current range from 25% to 200%. Turn off the output current when pulling this pin below 0.2V. Connect a 1nF–10nF capacitor for normal operation ($V_{EN/DIM}=1.28V$).
4	RS	LED Current Sense Input. Connect the current sense resistor to this pin.
5	IN	Input Supply. Connect an appropriate decoupling capacitor from IN pin to GND.

TYPICAL PERFORMANCE CHARACTERISTICS

$V_{IN}=30V$, 3 LEDs in series, $I_{OUT}=550mA$, unless otherwise noted.

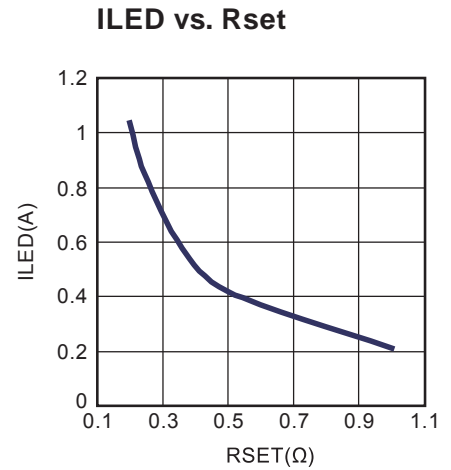
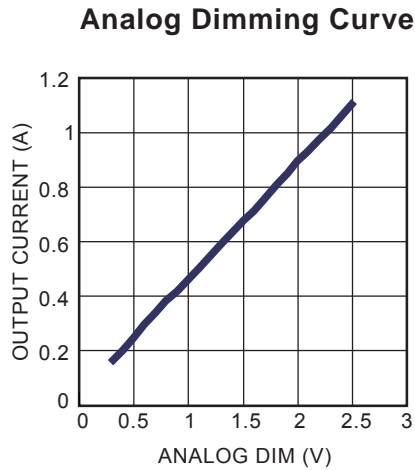
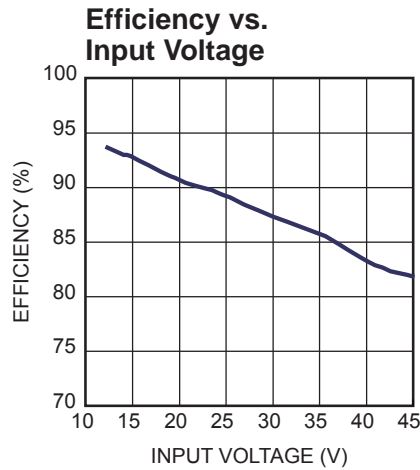

Steady State

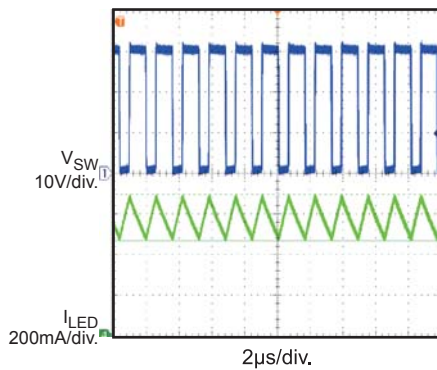

V_{in} Startup

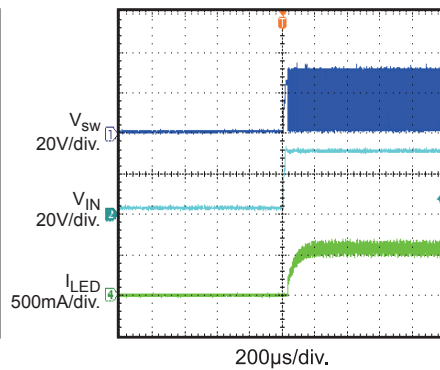

V_{en} Startup

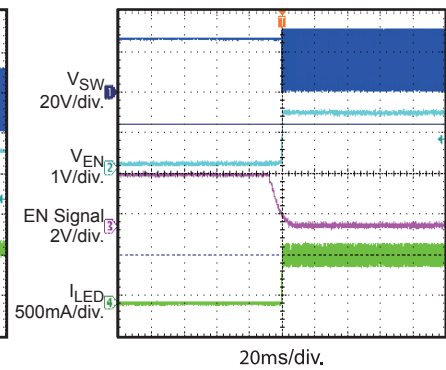

PWM Dimming □

$f_{PWM} = 200Hz$, $D_{PWM} = 50\%$

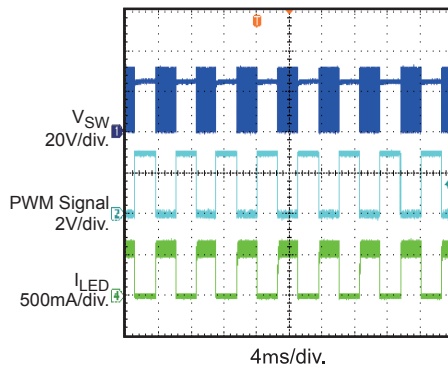

Open LED Protection

Open LEDs at working

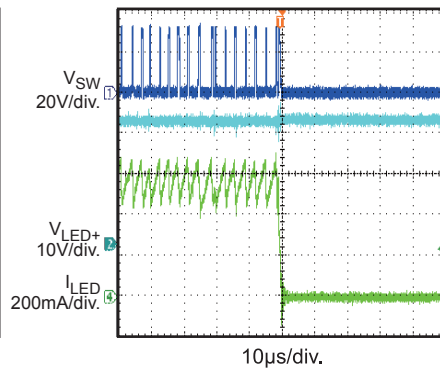

Short LED Protection

Short LEDs at working

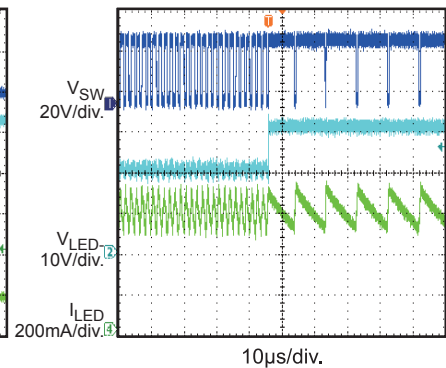

FUNCTION DIAGRAM

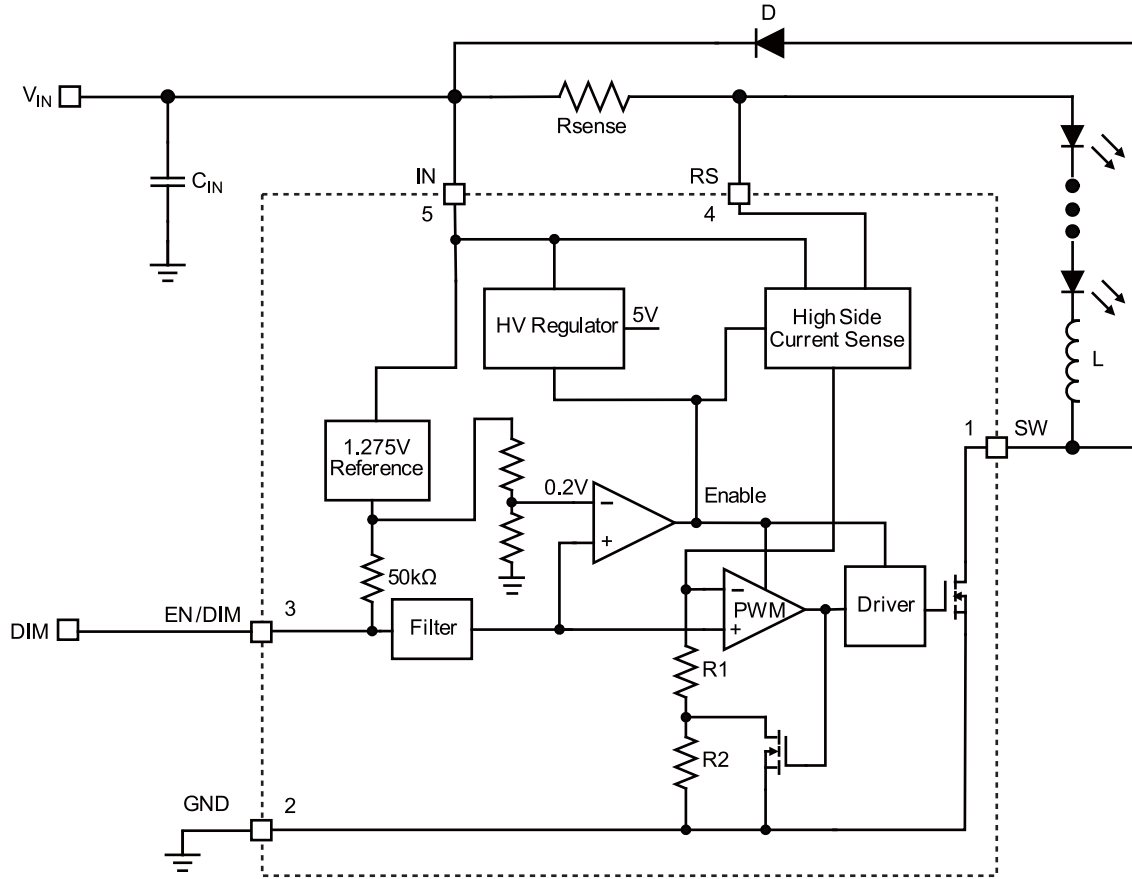

Figure 1: MP24892 Functional Block Diagram

OPERATION

Steady State

The MP24892 is a hysteretic-controlled step-down LED driver that is easily configured for various applications with an input range of 6V–45V. The converter employs a high-side current sensing resistor to detect and regulate the LED current. The voltage across the current sensing resistor is kept measured and regulated in 202mV±30mV range.

The internal 1.275V reference voltage provides a 0.2V reference to enable the part and a 1.275V pull-up voltage as the current reference. When $V_{EN} > 0.2V$, the output of the comparator goes high and the other blocks are enabled.

Output current is sensed through a high-side resistor, R_{SENSE} . When the switch turns on, the internal resistor R2 shorts out and R1 determines the output current upper-threshold. When the switch is off, R1 and R2 determine the output current lower-threshold. The ratio of R1 and R2 determines the current hysteresis.

Enable Control

Once the input voltage is applied, a 2µA current is sourced out from EN/DIM pin. If EN/DIM is left open, the IC will automatically start up to the maximum brightness. Applying a capacitor on this pin programs a soft start time.

Applying an external voltage in the range of 0.2V to 1.25V to this pin linearly controls the current sensing voltage reference from 0mV to 202mV for analog dimming.

Applying an external PWM signal with an amplitude of approximately 1.25V to this pin enables PWM dimming. For more on the flexible external PWM dimming method, please refer to the selecting dimming control mode section.

System Soft-Start

The voltage on the EN/DIM pin functions as the inductor current reference. An external capacitor from the EN/DIM pin to ground provides a soft-start delay. When V_{IN} starts, the internal voltage source charges the capacitor from 0V to 1.25V.

Dimming Control

MP24892 provides two dimming methods: PWM dimming and DC analog dimming.

To use PWM dimming, apply a square wave to the EN/DIM pin. To use analog dimming, apply a 0.3V–2.5V DC voltage to this pin.

APPLICATION INFORMATION

Setting the LED Current

The LED current is set by the current sense resistor between the IN pin and RS pin.

$$R_{SENSE} = 202\text{mV}/I_{LED}$$

For $R_{SET} = 0.36\Omega$, the LED current is set to 550mA

Selecting the Inductor

A lower inductance value results in a higher switching frequency, which causes greater switching losses. Select a switching frequency between 200kHz to 600kHz for most application. Estimate the inductor value using the equation below, where f_{SW} is the switching frequency:

$$L = \frac{\left(1 - \frac{V_{OUT}}{V_{IN}}\right) \times V_{OUT}}{0.3 \times I_{LED} \times f_{SW}}$$

For higher efficiency, select an inductor with the lowest DC resistance possible.

Selecting the Diode

The output diode supplies current to the inductor when the internal MOSFET is off. To reduce losses due to diode forward voltage and recovery time, use a Schottky diode rated for a reverse voltage greater than the input voltage. The average current rating must exceed the maximum expected load current, and the peak current rating must exceed the peak inductor current.

Selecting the Input Capacitor

The input capacitor reduces the surge current drawn from the input supply and the switching noise from the device. Use a $10\mu\text{F}$ – $22\mu\text{F}$ capacitor with a voltage rating that exceeds the input voltage for most applications. Select a capacitor with low ESR.

Selecting the Output Capacitor

An output capacitor is not necessary for most applications, but if the peak-to-peak ripple LED current must be less than 30% of the average current, add a capacitor across the LEDs. The ripple current is inversely proportional to the capacitor value. Use a $2.2\mu\text{F}$ capacitor for most applications.

Selecting Soft-Start Capacitor

The delay time can be estimated as $0.2\text{ms}/\text{nF}$ with the soft-start capacitor. In PWM dimming,

use a capacitor $C_{IN} < 2.2\text{nF}$ to eliminate its effect on the LED average current.

Selecting Dimming Control Mode

MP24892 provides two dimming methods: DC analog dimming and PWM dimming.

1. DC analog dimming mode

Apply a 0.3V-to-2.5V DC voltage to the EN/DIM pin. This voltage linearly changes the inductor current reference the inductor current range from 25% to 200%. (see Figure 2)

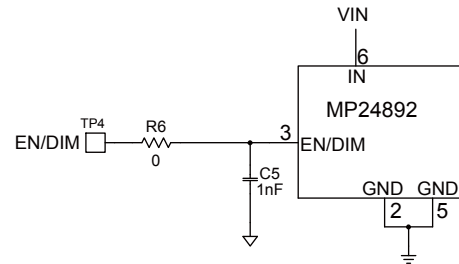

Figure 2: Analog Dimming External Circuit

2. PWM dimming mode

Apply a 100Hz-to-2kHz square waveform to the EN/DIM pin. The average LED current is proportional to PWM duty cycle. Because this pin is pulled up by the 1.25V internal source as the inductor current reference, use an NPN-transistor on/off circuit to separate the PWM signal from the current reference (see Figure 2). The minimum amplitude of the PWM signal is 1.5V.

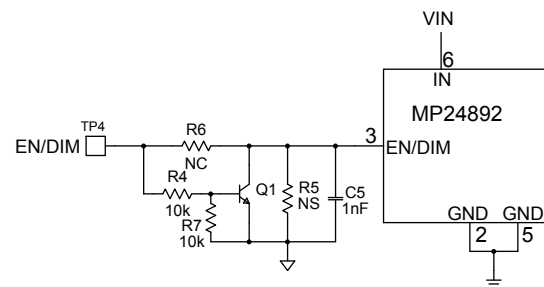

Figure 3: PWM Dimming External Circuit

Layout Consideration

Pay close attention to the PCB board layout and component placement. Place R_{SENSE} close to the IN and RS pins to minimize the set current error. The input loop—including the input capacitor, the Schottky diode, and the internal MOSFET—should be as short as possible.

PACKAGE INFORMATION

TSOT23-5

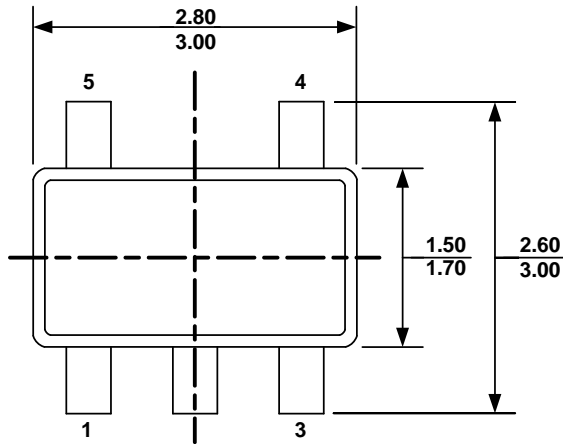

TOP VIEW

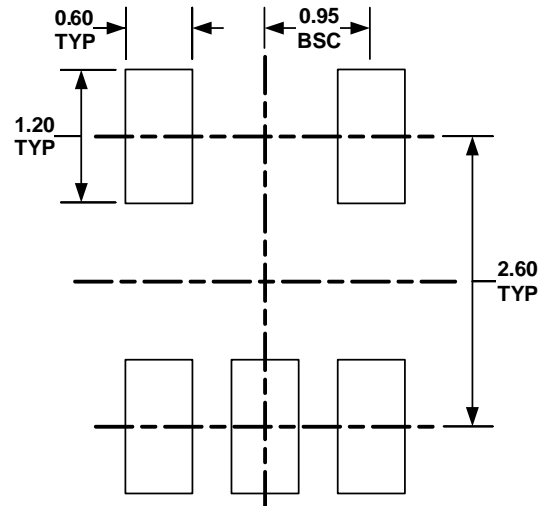

RECOMMENDED LAND PATTERN

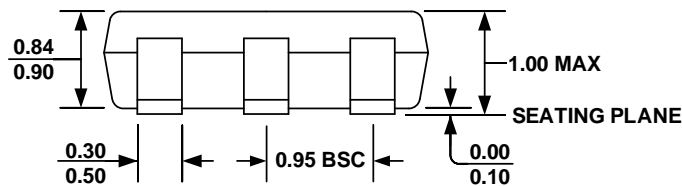

FRONT VIEW

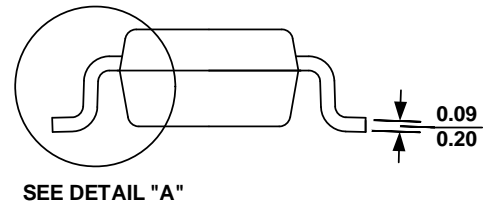

SIDE VIEW

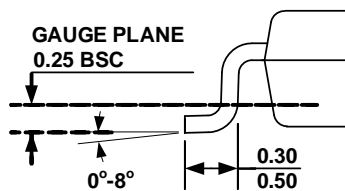

DETAIL "A"

NOTE:

- 1) ALL DIMENSIONS ARE IN MILLIMETERS
- 2) PACKAGE LENGTH DOES NOT INCLUDE MOLD FLASH; PROTRUSION OR GATE BURR
- 3) PACKAGE WIDTH DOES NOT INCLUDE INTERLEAD FLASH OR PROTRUSION.
- 4) LEAD COPLANARITY(BOTTOM OF LEADS AFTER FORMING) SHALL BE 0.10 MILLIMETERS MAX
- 5) DRAWING CONFORMS TO JEDEC MO-193, VARIATION AA
- 6) DRAWING IS NOT TO SCALE

NOTICE: The information in this document is subject to change without notice. Users should warrant and guarantee that third party Intellectual Property rights are not infringed upon when integrating MPS products into any application. MPS will not assume any legal responsibility for any said applications.