

UTC ULN2803 LINEAR INTEGRATED CIRCUIT

EIGHT DARLINGTON ARRAYS

DESCRIPTION

The UTC ULN2803 is high-voltage, high-current Darlington drivers comprised of eight NPN Darlington pairs.

FEATURES

- *Output current (single output) 500mA MAX.
- *High sustaining voltage output 50V MIN.
- *Output clamp diodes
- *Inputs compatible with various types of logic

APPLICATIONS

*Relay, hammer, lamp and display (LED) drivers.

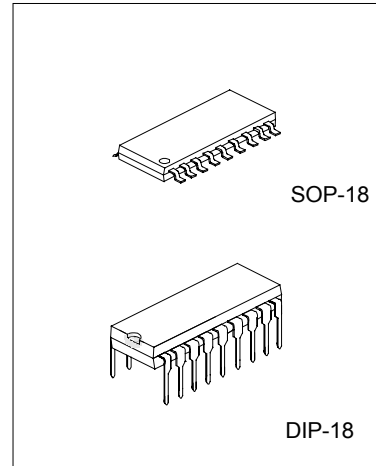

SCHEMATICS (EACH DRIVER)

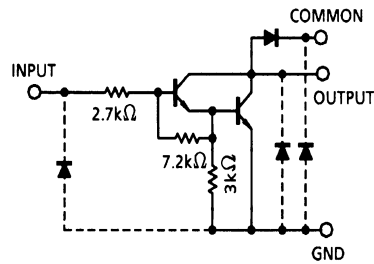

Note: The input and output parasitic diodes cannot be used as clamp diodes.

PIN CONFIGURATIONS

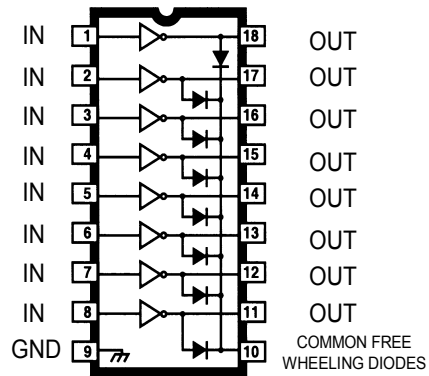

UTCULN2803 LINEAR INTEGRATED CIRCUIT

ABSOLUTE MAXIMUM RATINGS

PARAMETER	SYMBOL	VALUE	UNIT
Input Voltage	V_{IN}	-0.5~30	V
Output Sustaining Voltage	$V_{CE(SUS)}$	-0.5~50	V
Output Current	I_{OUT}	500	mA/ch
Clamp Diode Reverse Voltage	V_R	50	V
Clamp Diode Forward Current	I_F	500	mA
Power Dissipation	P_D	DIP: 1.47 SOP:0.54/0.625(Note)	W
Operating Ambient Temperature Range	T_{opr}	-40 to +85	°C
Storage Temperature Range	T_{Stg}	-55 to +150	°C

Note: On glass epoxy PCB (30x30x1.6mm Cu 50%)

ELECTRICAL CHARACTERISTICS (Ta = 25 °C, Unless otherwise specified)

PARAMETER	SYMBOL	TEST CONDITIONS	MIN	TYP	MAX	UNIT	FIG
Output Leakage Current	I_{CEX}	$V_{CE}=50V, T_A=25^{\circ}C$ $V_{CE}=50V, T_A=85^{\circ}C$			50 100	μA	1
Collector-Emitter Saturation Voltage	$V_{CE(SAT)}$	$I_{OUT}=350mA, I_{IN}=500\mu A$ $I_{OUT}=200mA, I_{IN}=350\mu A$ $I_{OUT}=100mA, I_{IN}=250\mu A$		1.3 1.1 0.9	1.6 1.3 1.1	V	2
Input Current (output on)	$I_{IN(ON)}$	$V_{IN}=3.85V, I_{OUT}=350mA$		0.93	1.35	mA	3
Input Current (output off)	$I_{IN(OFF)}$	$I_{OUT}=500\mu A, T_A=85^{\circ}C$	50	65		μA	4
Input Voltage (output on)	$V_{IN(ON)}$	$V_{CE}=2.0V$ $I_{OUT}=200mA$ $I_{OUT}=250mA$ $I_{OUT}=300mA$			2.4 2.7 3.0	V	5
Clamp Diode Reverse Current	I_R	$V_R=50V, T_A=25^{\circ}C$ $V_R=50V, T_A=85^{\circ}C$			50 100	μA	6
Clamp Diode Forward Voltage	V_F	$I_F=350mA$			2.0	V	7
Input Capacitance	C_{IN}			15	25	pF	-
Turn-On Delay	t_{ON}	$V_{OUT}=50V, R_L=125\Omega, C_L=15pF$		0.1	1	μS	8
Turn-Off Delay	t_{OFF}	$V_{OUT}=50V, R_L=125\Omega, C_L=15pF$		0.2	1	μS	8

UTCULN2803 LINEAR INTEGRATED CIRCUIT

TEST CIRCUIT

1. I_{CEX}

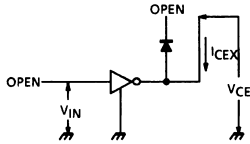

2. $V_{CE(sat)}$, h_{FE}

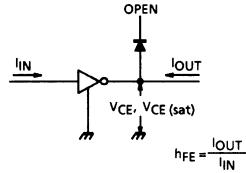

3. $I_{IN(ON)}$

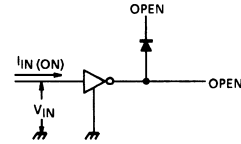

4. $I_{IN(OFF)}$

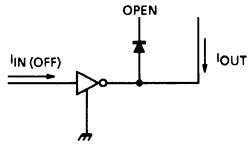

5. $V_{IN(ON)}$

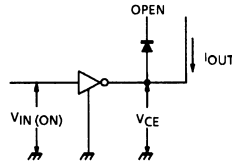

6. I_R

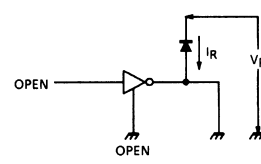

7. V_F

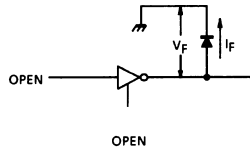

UTCULN2803 LINEAR INTEGRATED CIRCUIT

8. tON, tOFF

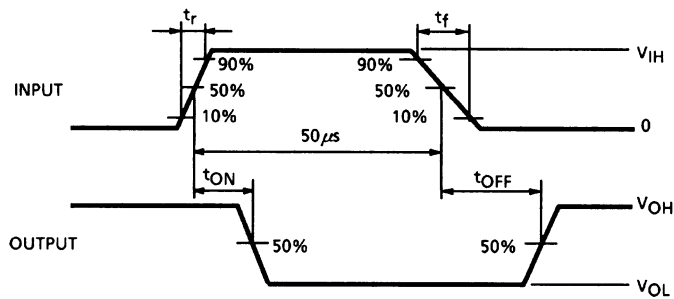
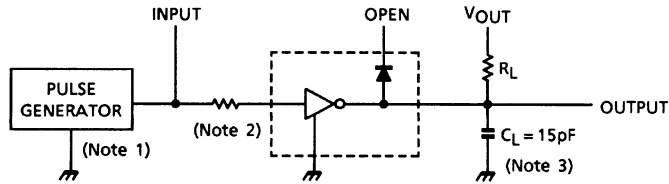

- Note1: Pulse width 50µs, duty cycle 10%
Output impedance 50Ω, $t_r \leq 5\text{ns}$, $t_f \leq 10\text{ns}$
- Note2: R1: 0, V_{IH} : 3V
- Note3: C_L includes probe and jig capacitance.

UTCULN2803 LINEAR INTEGRATED CIRCUIT

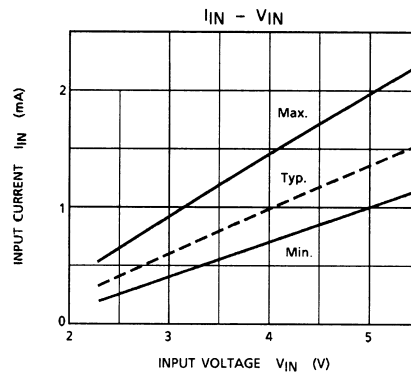
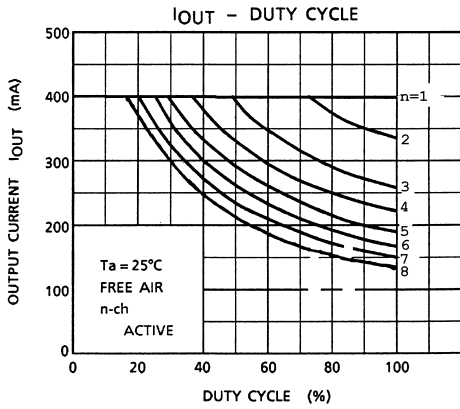
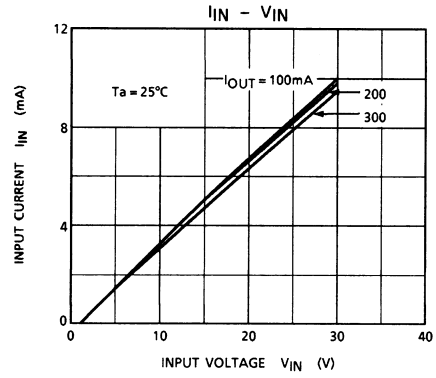
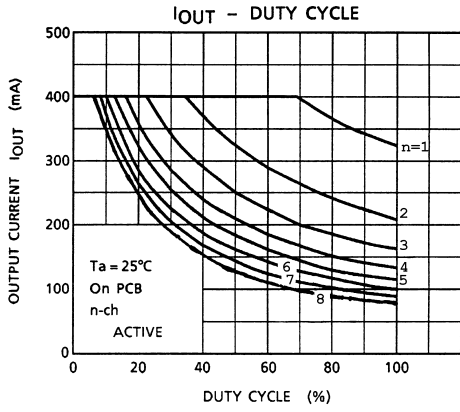

UTCULN2803 LINEAR INTEGRATED CIRCUIT

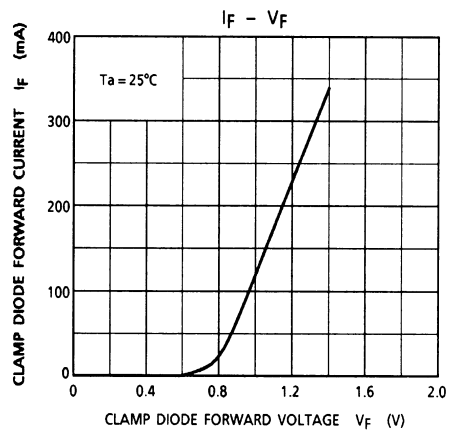
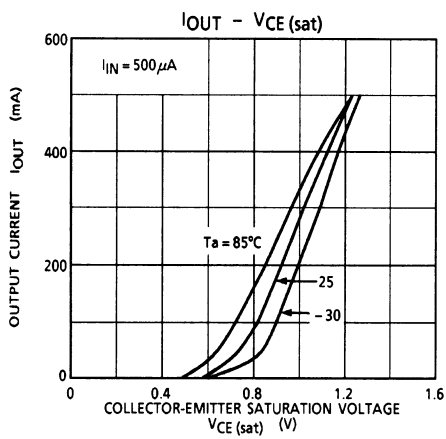
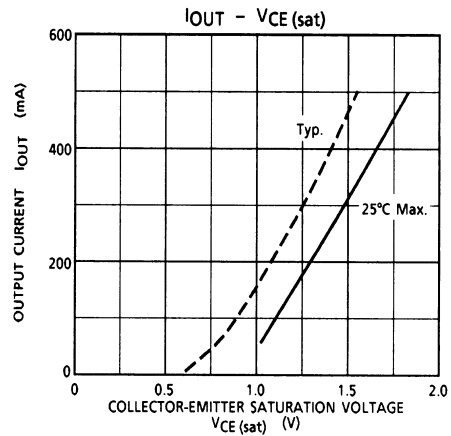
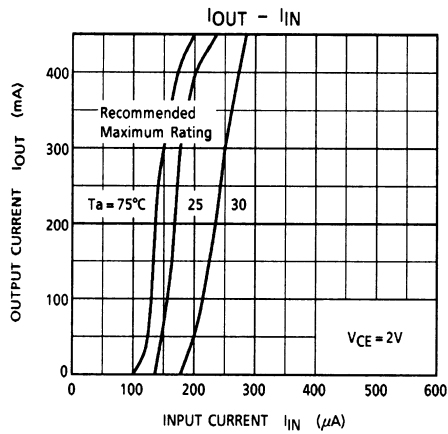

UTCULN2803 LINEAR INTEGRATED CIRCUIT

