

# Notice for TAIYO YUDEN products

Please read this notice before using the TAIYO YUDEN products.



## REMINDERS

- Product information in this catalog is as of October 2008. All of the contents specified herein are subject to change without notice due to technical improvements, etc. Therefore, please check for the latest information carefully before practical application or usage of the Products.

Please note that Taiyo Yuden Co., Ltd. shall not be responsible for any defects in products or equipment incorporating such products, which are caused under the conditions other than those specified in this catalog or individual specification.

- Please contact Taiyo Yuden Co., Ltd. for further details of product specifications as the individual specification is available.
- Please conduct validation and verification of products in actual condition of mounting and operating environment before commercial shipment of the equipment.
- All electronic components or functional modules listed in this catalog are developed, designed and intended for use in general electronics equipment.(for AV, office automation, household, office supply, information service, telecommunications, (such as mobile phone or PC) etc.). Before incorporating the components or devices into any equipment in the field such as transportation,( automotive control, train control, ship control), transportation signal, disaster prevention, medical, public information network (telephone exchange, base station) etc. which may have direct influence to harm or injure a human body, please contact Taiyo Yuden Co., Ltd. for more detail in advance.

Do not incorporate the products into any equipment in fields such as aerospace, aviation, nuclear control, submarine system, military, etc. where higher safety and reliability are especially required.

In addition, even electronic components or functional modules that are used for the general electronic equipment, if the equipment or the electric circuit require high safety or reliability function or performances, a sufficient reliability evaluation check for safety shall be performed before commercial shipment and moreover, due consideration to install a protective circuit is strongly recommended at customer's design stage.

- The contents of this catalog are applicable to the products which are purchased from our sales offices or distributors (so called "TAIYO YUDEN' s official sales channel"). It is only applicable to the products purchased from any of TAIYO YUDEN' s official sales channel.
- Please note that Taiyo Yuden Co., Ltd. shall have no responsibility for any controversies or disputes that may occur in connection with a third party's intellectual property rights and other related rights arising from your usage of products in this catalog. Taiyo Yuden Co., Ltd. grants no license for such rights.
- Caution for export  
Certain items in this catalog may require specific procedures for export according to "Foreign Exchange and Foreign Trade Control Law" of Japan, "U.S. Export Administration Regulations," and other applicable regulations. Should you have any question or inquiry on this matter, please contact our sales staff.  
Should you have any question or inquiry on this matter, please contact our sales staff.

# SMD インダクタ (コンパクトタイプ)

## SMD INDUCTORS COMPACT TYPE



OPERATING TEMP.	-25~+105°C (製品自己発熱含む) (Including self-generated heat)
-----------------	--



### 特長 FEATURES

・BRC 2016/BRL 3225 (新製品)  
一面電極構造採用により、最大効率設計を実現しました。  
DC/DCコンバータなどの大電流を必要とする、回路設計に適した小型・低背型チップインダクタです。

・BRC 2016/BRL 3225 (NEW PRODUCTS)  
The best efficiency design is achieved by adopting bottom-surface electrode structure. Small and low-profile Wound Chip Inductors that are suit for module design which needs high electric current like DC/DC converters.

### 用途 APPLICATIONS

・携帯電話、HDD、DVC、DSC、PDA、液晶ディスプレイ等の小型DC/DCコンバータ用途

For small DC/DC converter (cellular phone, HDD, DVC, DSC, PDA, LCD display etc).

### 形名表記法 ORDERING CODE

<b>1</b>	<b>3</b>	<b>5</b>	<b>6</b>
形式	外形寸法 (W×L) : mm (inch)	公称インダクタンス [μH]	インダクタンス許容差
BR   SMDインダクタ	1608 (0603)   1.6×0.8 mm 2012 (0805)   2.0×1.2 mm 2016 (0806)   2.0×1.6 mm 2518 (1007)   2.5×1.8 mm 3225 (1210)   3.2×2.5 mm	例   R20   0.2 1R0   1.0 2R2   2.2 4R7   4.7	M   ±20% K   ±10%
<b>2</b>	<b>4</b>		<b>7</b>
特性仕様	包装		当社管理番号
△   低Rdc L   低背 C   大電流	T   テーピング		△△△   標準品 △=スペース



<b>1</b>	<b>3</b>	<b>5</b>	<b>6</b>
Type	外形寸法 (W×L) : mm (inch)	Nominal Inductance [μH]	Inductance tolerance
BR   SMD Inductors	1608 (0603)   1.6×0.8 mm 2012 (0805)   2.0×1.2 mm 2016 (0806)   2.0×1.6 mm 2518 (1007)   2.5×1.8 mm 3225 (1210)   3.2×2.5 mm	example   R20   0.2 1R0   1.0 2R2   2.2 4R7   4.7	M   ±20% K   ±10%
<b>2</b>	<b>4</b>		<b>7</b>
Characteristic Spec	Packaging		Internal code
L   Low profile C   High Current	T   Tape and Reel		△   Standard product △=Blank Space

# 外形寸法 EXTERNAL DIMENSIONS

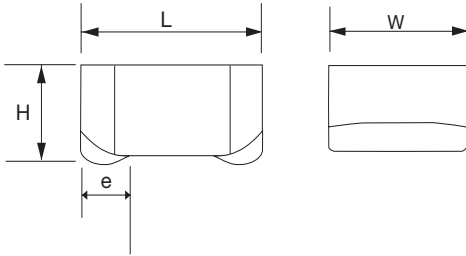

Type	L	W	H	e
BR C1608	1.6±0.2 (0.063±0.008)	0.8±0.2 (0.031±0.008)	0.8±0.2 (0.031±0.008)	0.45±0.15 (0.016±0.006)
BR L2012	2.0±0.2 (0.078±0.008)	1.25±0.2 (0.049±0.008)	1.0 max (0.040 max)	0.5±0.2 (0.020±0.008)
BR C2016	2.0±0.2 (0.078±0.008)	1.6±0.2 (0.063±0.008)	1.6±0.2 (0.063±0.008)	0.5±0.2 (0.020±0.008)
BR L2518	2.5±0.2 (0.098±0.008)	1.8±0.2 (0.071±0.008)	1.2 max (0.048 max)	0.5±0.2 (0.020±0.008)
BR L3225	3.2±0.2 (0.126±0.008)	2.5±0.2 (0.098±0.008)	1.7 max (0.068 max)	0.75±0.2 (0.03±0.008)

Unit : mm (inch)

## 推奨ランド Recommended Land Patterns

### 実装上の注意

- ・実装状態を確認の上ご使用下さいますようお願いいたします。
- ・本製品のはんだ付けはリフローはんだ工法に限ります。

### Surface Mounting

- ・ Mounting and soldering conditions should be checked beforehand.
- ・ Applicable soldering process to this products is reflow soldering only.

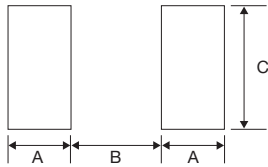

Type	A	B	C
1608	0.55	0.80	1.00
2012	0.65	0.90	1.40
2016	0.70	0.80	1.80
2518	0.65	1.50	1.95
3225	1.00	1.60	2.70

Unit : mm

# 概略バリエーション AVAILABLE INDUCTANCE RANGE

Range	Type	BR L3225		BR L2518		BR C2016		BR L2012		BR C1608	
		Imax [mA]	Rdc±30% [Ω]	Imax [mA]	Rdc±30% [Ω]	Imax [mA]	Rdc±30% [Ω]	Imax [mA]	Rdc±30% [Ω]	Imax [mA]	Rdc±30% [Ω]
Inductance [μH]	1.0	2,200	0.043	1,000	0.080	1,100	0.085	1,050	0.090	980	0.060
	2.2	700	0.350	850	0.135	520	0.400	850	0.135	520	0.180
	4.7	250	2.50	470	0.400	170	3.40	270	0.850	280	0.550
	10	100	100μH	100	100μH	100	100μH	100	100μH	100	100μH
	22	220	220	220μH	220	220μH	220	220μH	220	220μH	220
Examples	Inductance	Imax [mA]	Rdc±20% [Ω]	Imax [mA]	Rdc±30% [Ω]	Imax [mA]	Rdc±30% [Ω]	Imax [mA]	Rdc±30% [Ω]	Imax [mA]	Rdc±30% [Ω]
	1 μH	2,200(1.0 μH)	0.043(1.0 μH)	1,000(1.0 μH)	0.080(1.0 μH)	1,100(1.0 μH)	0.085(1.0 μH)	1,050(0.47 μH)	0.090(0.47 μH)	980(0.20 μH)	0.060(0.20 μH)
	2.2 μH	700(10 μH)	0.350(10 μH)	850(2.2 μH)	0.135(2.2 μH)	520(10 μH)	0.400(10 μH)	270(10 μH)	0.850(10 μH)	520(1.0 μH)	0.180(1.0 μH)
4.7 μH	250(100 μH)	2.50(100 μH)	470(4.7 μH)	0.400(4.7 μH)	170(100 μH)	3.40(100 μH)	85(100 μH)	7.70(100 μH)	280(2.2 μH)	0.550(2.2 μH)	

セレクションガイド  
Selection Guide

アイテム一覧  
Part Numbers

特性図  
Electrical Characteristics

梱包  
Packaging

信頼性  
Reliability Data

使用上の注意  
Precautions



etc

△当社カタログをご使用の際には「当社製品に関するお断り」を必ずお読みください。

TAIYO YUDEN 2009

△Please read the "Notice for TAIYO YUDEN products" before using this catalog.

アイテム一覧 PART NUMBERS

BR C1608 type

形名 Ordering code	EHS (Environmental Hazardous Substances)	公称 インダクタンス Inductance [μH]	インダクタンス 許容差 Inductance Tolerance	自己共振 周波数 Self-resonant frequency [MHz] min	直流抵抗 DC Resistance [Ω] (±30%)	定格電流※) Rated current [mA]		測定 周波数 Measuring frequency [MHz]
						直流重量許容電流 Saturation current Idc1	温度上昇許容 Temperature rise current Idc2	
BR C1608TR20M	RoHS	0.20	±20%	400	0.060	1750	980	7.96
BR C1608TR35M	RoHS	0.35		300	0.080	1400	810	
BR C1608TR45M	RoHS	0.45		200	0.090	1250	800	
BR C1608TR56M	RoHS	0.56		170	0.095	1150	760	
BR C1608TR77M	RoHS	0.77		150	0.110	1000	660	
BR C1608T1R0M	RoHS	1.00		140	0.180	850	520	
BR C1608T1R5M	RoHS	1.50		120	0.300	700	410	
BR C1608T2R2M	RoHS	2.20		100	0.550	550	280	

BR L2012 type

形名 Ordering code	EHS (Environmental Hazardous Substances)	公称 インダクタンス Inductance [μH]	インダクタンス 許容差 Inductance Tolerance	自己共振 周波数 Self-resonant frequency [MHz] min	直流抵抗 DC Resistance [Ω] (±30%)	定格電流※) Rated current [mA]		測定 周波数 Measuring frequency [MHz]
						直流重量許容電流 Saturation current Idc1	温度上昇許容 Temperature rise current Idc2	
BR L2012TR47M	RoHS	0.47	±20%	350	0.090	1,100	1,050	7.96
BR L2012T1R0M	RoHS	1.0		300	0.135	850	850	
BR L2012T1R5M	RoHS	1.5		250	0.180	700	750	
BR L2012T2R2M	RoHS	2.2		200	0.300	600	550	
BR L2012T3R3M	RoHS	3.3		190	0.500	490	440	
BR L2012T4R7M	RoHS	4.7		150	0.550	340	400	
BR L2012T6R8M	RoHS	6.8		60	0.750	290	350	
BR L2012T100M	RoHS	10		30	0.850	270	330	
BR L2012T150M	RoHS	15		15	1.00	220	300	
BR L2012T220M	RoHS	22		13	1.30	190	270	
BR L2012T330M	RoHS	33	8.0	2.00	150	220	2.52	
BR L2012T470M	RoHS	47	7.0	3.50	125	160		
BR L2012T680M	RoHS	68	6.5	5.80	100	110		
BR L2012T101M	RoHS	100	6.0	7.70	85	85		
								0.796

BR C2016 type

形名 Ordering code	EHS (Environmental Hazardous Substances)	公称 インダクタンス Inductance [μH]	インダクタンス 許容差 Inductance Tolerance	自己共振 周波数 Self-resonant frequency [MHz] min	直流抵抗 DC Resistance [Ω] (±30%)	定格電流※) Rated current [mA]		測定 周波数 Measuring frequency [MHz]
						直流重量許容電流 Saturation current Idc1	温度上昇許容 Temperature rise current Idc2	
BR C2016T1R0M	RoHS	1.0	±20%	450	0.085	1,350	1,100	0.10
BR C2016T1R5M	RoHS	1.5		370	0.150	1,100	820	
BR C2016T2R2M	RoHS	2.2		250	0.180	910	760	
BR C2016T3R3M	RoHS	3.3		140	0.220	740	680	
BR C2016T4R7M	RoHS	4.7		78	0.270	660	610	
BR C2016T6R8M	RoHS	6.8		39	0.330	550	560	
BR C2016T100□	RoHS	10	±20% ±10%	35	0.400	450	520	
BR C2016T150□	RoHS	15		28	0.600	400	410	
BR C2016T220□	RoHS	22		24	1.00	310	310	
BR C2016T330□	RoHS	33		13	1.70	270	240	
BR C2016T470□	RoHS	47		11	2.20	210	210	
BR C2016T680□	RoHS	68		8	2.80	200	190	
BR C2016T101□	RoHS	100		7	3.40	140	170	

(注)形名の□にはインダクタンス許容差記号(MまたはK)が入ります。  
 ・Please specify the inductance tolerance code. (M or K)

※)直流重量許容電流 (Idc1)は、直流重量によるインダクタンス低下が-30%以内となる直流電流値 (at 20°C)  
 The saturation current value (Idc1) is the DC current value having inductance decrease down to 30%. (at 20°C)

※)温度上昇許容電流 (Idc2)は、温度上昇が40°Cとなる直流電流値 (at 20°C)  
 The temperature rise current value (Idc2) is the DC current value having temperature increase up to 40°C. (at 20°C)

※)定格電流値は直流重量許容電流、または温度上昇許容電流をいずれも満足する直流電流値  
 The rated current is the DC current value that satisfies both of DC saturation current value and temperature rise current value.

BR L2518 type

形名 Ordering code	EHS (Environmental Hazardous Substances)	公称 インダクタンス Inductance [μH]	インダクタンス 許容差 Inductance Tolerance	自己共振 周波数 Self-resonant frequency [MHz] min	直流抵抗 DC Resistance [Ω] (±30%)	定格電流※) Rated current [mA]		測定 周波数 Measuring frequency [MHz]
						直流重畳許容電流 Saturation current Idc1	温度上昇許容 Temperature rise current Idc2	
BR L2518T1R0M	RoHS	1.0	±20%	130	0.080	1600	1000	7.96
BR L2518T1R5M	RoHS	1.5		100	0.100	1200	920	
BR L2518T2R2M	RoHS	2.2		80	0.135	1000	850	
BR L2518T3R3M	RoHS	3.3		70	0.300	800	580	
BR L2518T4R7M	RoHS	4.7		60	0.400	700	470	

BR L3225 type

形名 Ordering code	EHS (Environmental Hazardous Substances)	公称 インダクタンス Inductance [μH]	インダクタンス 許容差 Inductance Tolerance	自己共振 周波数 Self-resonant frequency [MHz] min	直流抵抗 DC Resistance [Ω] (±20%)	定格電流※) Rated current [mA]		測定 周波数 Measuring frequency [MHz]
						直流重畳許容電流 Saturation current Idc1	温度上昇許容 Temperature rise current Idc2	
BR L3225T1R0M	RoHS	1.0	±20%	220	0.043	2,400	2,200	0.10
BR L3225T2R2M	RoHS	2.2		150	0.065	1,850	1,600	
BR L3225T4R7M	RoHS	4.7		120	0.180	1,300	1,000	
BR L3225T100□	RoHS	10	±20% ±10%	70	0.350	900	700	
BR L3225T220□	RoHS	22		50	0.690	550	470	
BR L3225T470□	RoHS	47		40	1.00	420	390	
BR L3225T101□	RoHS	100		30	2.50	270	250	

(注)形名の□にはインダクタンス許容差記号 (MまたはK)が入ります。

・ Please specify the inductance tolerance code. (M or K)

※) 直流重畳許容電流 (Idc1) は、直流重畳によるインダクタンス低下が-30%以内となる直流電流値 (at 20°C)  
The saturation current value (Idc1) is the DC current value having inductance decrease down to 30%. (at 20°C)

※) 温度上昇許容電流 (Idc2) は、温度上昇が40°Cとなる直流電流値 (at 20°C)  
The temperature rise current value (Idc2) is the DC current value having temperature increase up to 40°C. (at 20°C)

※) 定格電流値は直流重畳許容電流、または温度上昇許容電流をいずれも満足する直流電流値  
The rated current is the DC current value that satisfies both of DC saturation current value and temperature rise current value.

直流重畳特性例 DC Bias characteristics (Measured by HP4285A)

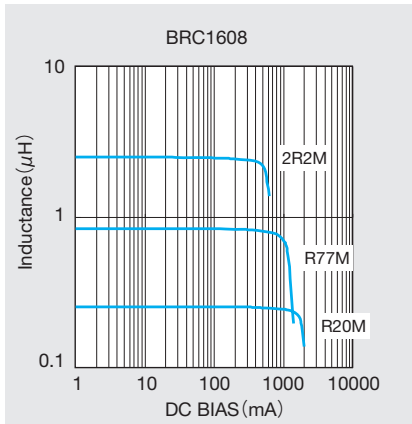
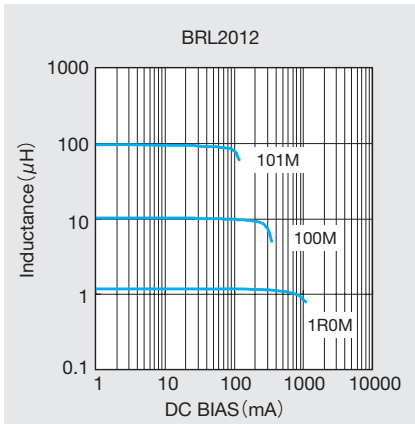
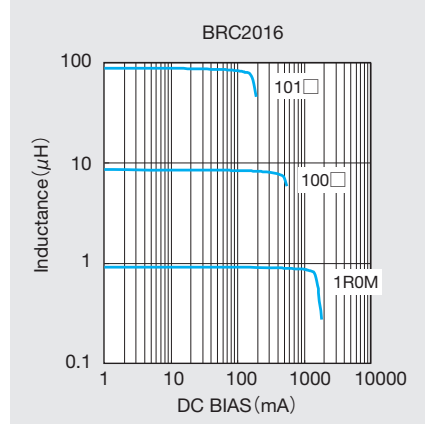
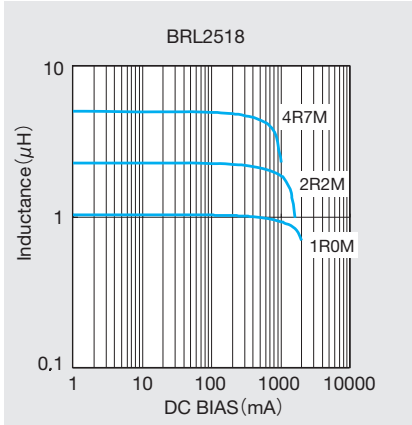
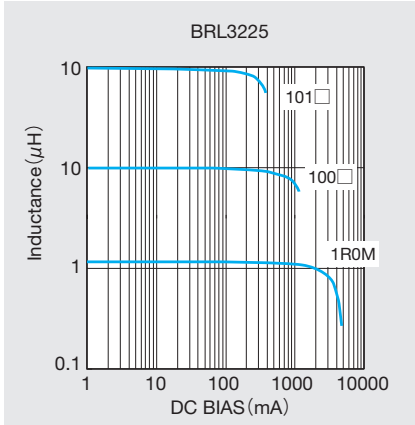

インピーダンス周波数特性 Impedance-vs-Frequency characteristics (Measured by HP4291A)

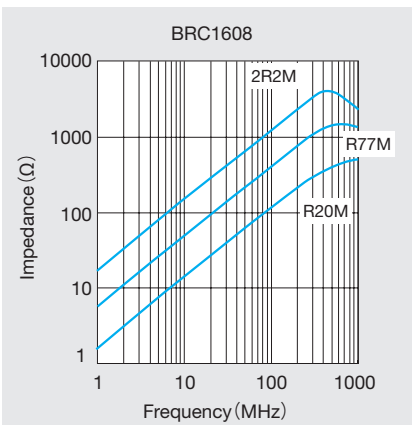
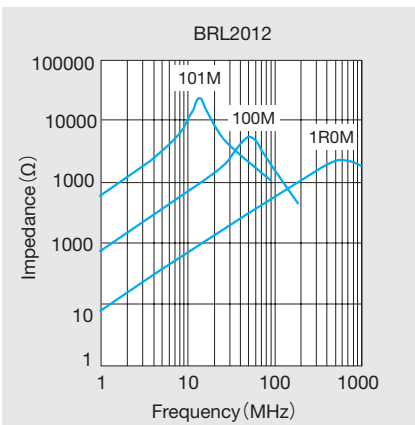
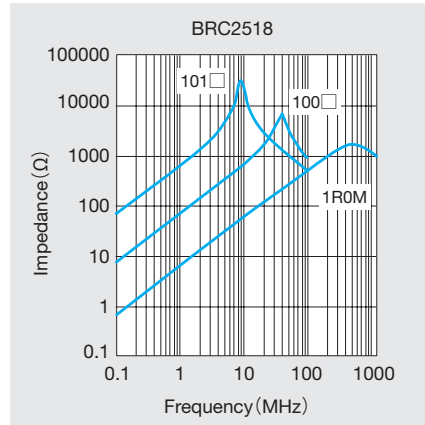
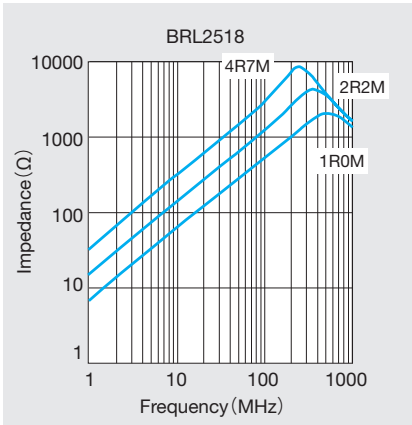
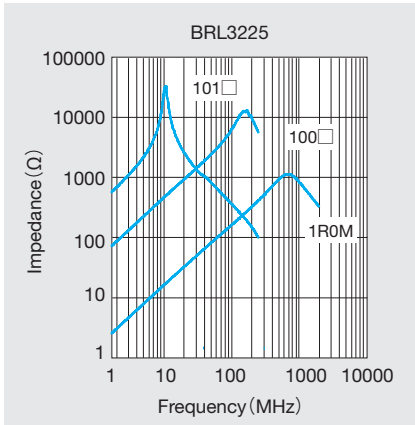

①最小受注単位数 Minimum Quantity

型式 Type	標準数量[個] Standard Quantity [pcs]	
	紙テーピング Paper Tape	エンボステーピング Embossed Tape
BR C1608	—	3000
BR L2012	—	3000
BR C2016	—	2000
BR L2518	—	3000
BR L3225	—	2000

②テーピング材質 Tape Material

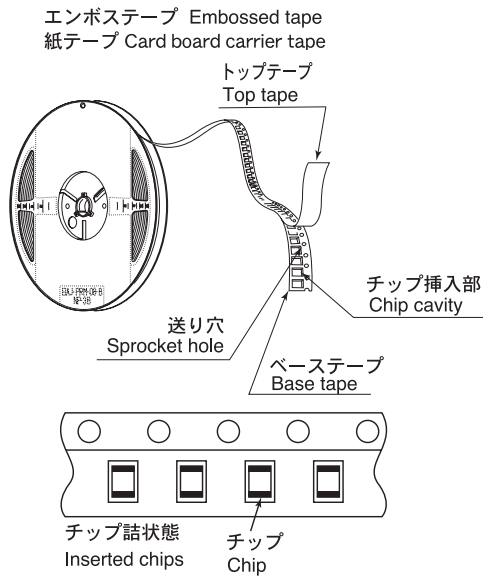

③テーピング寸法 Taping dimensions

エンボステープ (8mm幅) Embossed Tape (0.315 inches wide)  
紙テープ (8mm幅) Card board carrier tape (0.315 inches wide)

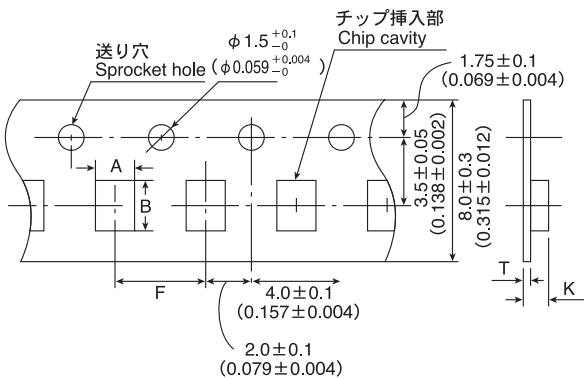

形式 Type	チップ挿入部 Chip cavity		挿入ピッチ Insertion pitch	テープ厚み Tape thickness	
	A	B		T	K
BR C1608	1.1 ± 0.5 (0.04 ± 0.002)	1.9 ± 0.5 (0.076 ± 0.002)	4.0 ± 0.1 (0.157 ± 0.004)	0.25 ± 0.05 (0.01 ± 0.002)	1.35max (0.054)
BR L2012	1.40 ± 0.1 (0.056 ± 0.004)	2.20 ± 0.1 (0.088 ± 0.004)	4.0 ± 0.1 (0.157 ± 0.004)	0.25 ± 0.05 (0.01 ± 0.002)	1.2max (0.048)
BR C2016	1.9 ± 0.2 (0.075 ± 0.008)	2.2 ± 0.2 (0.087 ± 0.008)	4.0 ± 0.1 (0.157 ± 0.004)	0.3 ± 0.05 (0.012 ± 0.002)	2.15MAX (0.085MAX)
BR L2518	2.3 ± 0.2 (0.092 ± 0.008)	2.8 ± 0.2 (0.112 ± 0.008)	4.0 ± 0.1 (0.157 ± 0.004)	0.3 ± 0.05 (0.012 ± 0.002)	1.5 max (0.060)
BR L3225	2.8 ± 0.1 (0.112 ± 0.004)	3.5 ± 0.1 (0.140 ± 0.004)	4.0 ± 0.1 (0.157 ± 0.004)	0.25 ± 0.05 (0.01 ± 0.002)	1.75 MAX (0.075)

Unit : mm (inch)

④リーダー部・空部 Leader and Blank portion

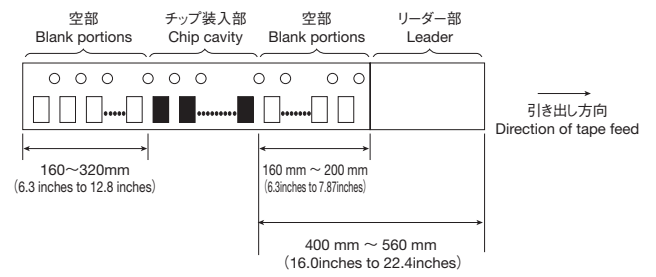

⑤リール寸法 Reel size

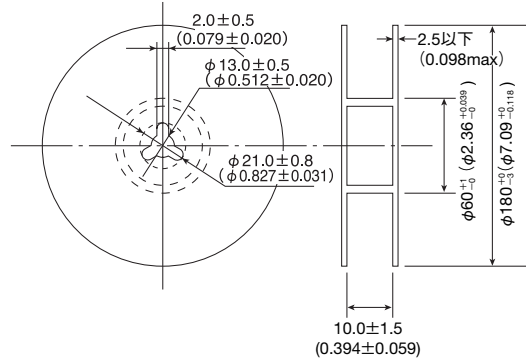

⑥トップテープ強度 Top Tape Strength

トップテープのはがし力は、下図矢印方向にて0.2~0.7Nとなります。  
The top tape requires a peel-off force of 0.2 to 0.7N in the direction of the arrow as illustrated below.

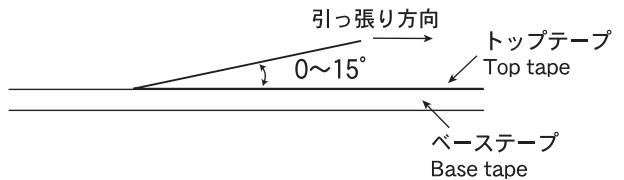

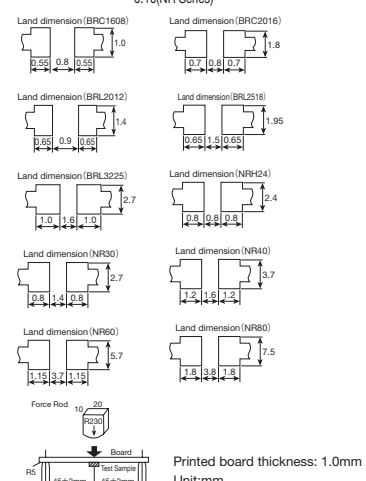
Item	Specified Value			Test Method and Remarks										
	BRC1608, BRL2012, BRC2016, BRL2518, BRL3225 Type	NRH24, NR30/40/60/80, NRG40 Type	NR10050 Type											
1. Operating Temperature Range	-25°C ~ +105°C	-25°C ~ +120°C	-25°C ~ +105°C	Including self-generated heat										
2. Storage Temperature Range	-40°C ~ +85°C			BRC1608, BRL2012, BRC2016, BRL2518, BRL3225 Type, NRH24, NR30/40/60/80, NRG4026 Type : 0 to 40°C for the product with taping. NR10050 Type : 0 ~ 40°C for the product with taping.										
3. Rated current	Within the specified tolerance			The maximum DC value having inductance decrease within specified value and temperature increase within 40°C by the application of DC bias. Inductance decrease BRC1608, BRL2012, BRC2016, BRL2518, BRL3225 Type, NRH24, NR30/40/60/80, NRG40 Type, NR10050 Type 30%										
4. Inductance	Within the specified tolerance			BRC1608, BRL2012, BRC2016, BRL2518, BRL3225 Type LCR Meter : HP 4285A or equivalent, Measuring frequency: Specified frequency NRH24, NR30/40/60/80, NRG4026 Type : LCR Meter : HP 4285A or equivalent, 100KHz, 1V NR10050 Type : LCR Meter : HP 4263A or equivalent, 100KHz, 1V										
5. DC Resistance	Within the specified tolerance			DC ohmmeter : HIOKI 3227 or equivalent										
6. Self resonance frequency	Within the specification			BRC1608, BRL2012, BRC2016, BRL2518, BRL3225 Type, NRH24, NR30/40/60/80 Type, NR10050 Type : Impedance analyzer/material analyzer : HP4291A or equivalent HP4191A, 4192A or equivalent										
7. Temperature characteristic	BRL2012, BRC2016, BRL2518, BRL3225 Inductance change : Within ± 15%  BRC1608 Inductance change : Within ± 20%	Inductance change : Within ± 20%		BRC1608, BRL2012, BRC2016, BRL2518, BRL3225 Type, NRH24, NR30/40/60/80, NRG4026 Type, NR10050 Type : Measurement of inductance shall be taken at temperature range within -25°C ~ +85°C. With reference to inductance value at +20°C., change rate shall be calculated. Change of maximum inductance deviation in step 1 to 5 <table border="1"> <tr> <td>Temperature at step 1</td> <td>20°C</td> </tr> <tr> <td>Temperature at step 2</td> <td>Minimum operating temperature</td> </tr> <tr> <td>Temperature at step 3</td> <td>20°C (Standard temperature)</td> </tr> <tr> <td>Temperature at step 4</td> <td>Maximum operating temperature</td> </tr> <tr> <td>Temperature at step 5</td> <td>20°C</td> </tr> </table>	Temperature at step 1	20°C	Temperature at step 2	Minimum operating temperature	Temperature at step 3	20°C (Standard temperature)	Temperature at step 4	Maximum operating temperature	Temperature at step 5	20°C
Temperature at step 1	20°C													
Temperature at step 2	Minimum operating temperature													
Temperature at step 3	20°C (Standard temperature)													
Temperature at step 4	Maximum operating temperature													
Temperature at step 5	20°C													
8. Resistance to flexure of substrate	No damage.			BRC1608, BRL2012, BRC2016, BRL2518, BRL3225 Type, NRH24, NR30/40/60/80, NRG4026 Type : The test samples shall be soldered to the test board by the reflow . As illustrated below, apply force in the direction of the arrow indicating until deflection of the test board reaches to 2 mm. Test board size : 100×40×1.0 Test board material : glass epoxy-resin Solder cream thickness : 0.15(BR Series) 0.10(NR Series) 										
9. Insulation resistance : between wires														
10. Insulation resistance : between wire and core														
11. Withstanding voltage : between wires and core														



12. Adhesion of terminal Item electrode	Specified Value			Test Method and Remarks														
	BRC1608, BRL2012, BRC2016, BRL2518, BRL3225 Type	NRH24, NR30/40/60/80, NRG40 Type	NR10050 Type															
	Shall not come off PC board.			BRC1608, BRL2012, BRC2016, BRL2518, BRL3225 Type, NRH24, NR30/40/60/80, NRG40 Type : The test samples shall be soldered to the test board by the reflow. Applied force : 10N to X and Y directions. Duration : 5s. Solder cream thickness : 0.15mm.  NR10050 Type : Applied force : 5N to X and Y directions. Duration : 5s.														
13. Resistance to vibration	Inductance change : Within $\pm 10\%$ No significant abnormality in appearance.			BRC1608, BRL2012, BRC2016, BRL2518, BRL3225 Type, NRH24, NR30/40/60/80, NRG40 Type, NR10050 Type : The test samples shall be soldered to the test board by the reflow. Then it shall be submitted to below test conditions. <table border="1" data-bbox="1085 928 1460 1124"> <tr> <td>Frequency Range</td> <td colspan="2">10~55Hz</td> </tr> <tr> <td>Total Amplitude</td> <td colspan="2">1.5mm (May not exceed acceleration 196 m/S<sup>2</sup>)</td> </tr> <tr> <td>Sweeping Method</td> <td colspan="2">10Hz to 55Hz to 10 Hz for 1 min.</td> </tr> <tr> <td rowspan="3">Time</td> <td>X</td> <td rowspan="3">For 2 hours on each X, Y, and Z axis.</td> </tr> <tr> <td>Y</td> </tr> <tr> <td>Z</td> </tr> </table> Recovery : At least 2hrs of recovery under the standard condition after the test, followed by the measurement within 48 hrs.	Frequency Range	10~55Hz		Total Amplitude	1.5mm (May not exceed acceleration 196 m/S <sup>2</sup> )		Sweeping Method	10Hz to 55Hz to 10 Hz for 1 min.		Time	X	For 2 hours on each X, Y, and Z axis.	Y	Z
Frequency Range	10~55Hz																	
Total Amplitude	1.5mm (May not exceed acceleration 196 m/S <sup>2</sup> )																	
Sweeping Method	10Hz to 55Hz to 10 Hz for 1 min.																	
Time	X	For 2 hours on each X, Y, and Z axis.																
	Y																	
	Z																	
14. Solderability	At least 90% of surface of terminal electrode is covered by new solder.			BRC1608, BRL2012, BRC2016, BRL2518, BRL3225 Type, NRH24, NR30/40/60/80, NRG40 Type, NR10050 Type : The test samples shall be dipped in flux, and then immersed in molten solder as shown in below table Flux : Methanol solution containing rosin 25%. NRH24, NR30/40/60/80 Type, NR10050 Type : <table border="1" data-bbox="1085 1528 1340 1594"> <tr> <td>Solder Temperature</td> <td>245 <math>\pm</math> 5°C</td> </tr> <tr> <td>Time</td> <td>5 <math>\pm</math> 1.0sec</td> </tr> </table> BRC1608, BRL2012, BRC2016, BRL2518, BRL3225 Type : <table border="1" data-bbox="1085 1638 1340 1703"> <tr> <td>Solder Temperature</td> <td>245 <math>\pm</math> 5°C</td> </tr> <tr> <td>Time</td> <td>5 <math>\pm</math> 0.5sec</td> </tr> </table> ※Immersion depth : All sides of mounting terminal shall be immersed.	Solder Temperature	245 $\pm$ 5°C	Time	5 $\pm$ 1.0sec	Solder Temperature	245 $\pm$ 5°C	Time	5 $\pm$ 0.5sec						
Solder Temperature	245 $\pm$ 5°C																	
Time	5 $\pm$ 1.0sec																	
Solder Temperature	245 $\pm$ 5°C																	
Time	5 $\pm$ 0.5sec																	

Item	Specified Value			Test Method and Remarks																		
	BRC1608, BRL2012, BRC2016, BRL2518, BRL3225 Type	NRH24, NR30/40/60/80, NRG40 Type	NR10050 Type																			
15. Resistance to soldering heat	Inductance change : Within $\pm 10\%$ No significant abnormality in appearance.			<p>BRC1608, BRL2012, BRC2016, BRL2518, BRL3225 Type : 3 times of reflow oven at 230°C MIN for 40 sec. with peak temperature at 260 <math>^{+0}_{-5}</math> °C for 5 sec.</p> <p>NRH24, NR30/40/60/80, NRG40 Type, NR10050 Type : The test sample shall be exposed to reflow oven at 230 <math>\pm 5</math> °C for 40 seconds, with peak temperature at 260 <math>\pm 5</math> °C for 5 seconds, 2 times.</p> <p>NR6020 Type : The test sample shall be exposed to reflow oven at 230 <math>\pm 5</math> °C for 40 seconds, with peak temperature at 250 <math>^{+5}_{-0}</math> °C for 5 seconds, 2 times.</p> <p>Test board thickness : 1.0 mm Test board material : glass epoxy-resin</p>																		
16. Thermal shock	Inductance change : Within $\pm 10\%$ No significant abnormality in appearance.			<p>BRC1608, BRL2012, BRC2016, BRL2518, BRL3225 Type, NRH24, NR30/40/60/80, NRG40 Type, NR10050 Type :</p> <p>The test samples shall be soldered to the test board by the reflow. The test samples shall be placed at specified temperature for specified time by step 1 to step 4 as shown in below table in sequence. The temperature cycle shall be repeated 100 cycles.</p> <table border="1" style="margin-left: auto; margin-right: auto;"> <thead> <tr> <th colspan="3">Conditions of 1 cycle</th> </tr> <tr> <th>Step</th> <th>Temperature (°C)</th> <th>Duration (min)</th> </tr> </thead> <tbody> <tr> <td>1</td> <td>-40 <math>\pm 3</math></td> <td>30 <math>\pm 3</math></td> </tr> <tr> <td>2</td> <td>Room temperature</td> <td>Within 3</td> </tr> <tr> <td>3</td> <td>+85 <math>\pm 2</math></td> <td>30 <math>\pm 3</math></td> </tr> <tr> <td>4</td> <td>Room temperature</td> <td>Within 3</td> </tr> </tbody> </table>	Conditions of 1 cycle			Step	Temperature (°C)	Duration (min)	1	-40 $\pm 3$	30 $\pm 3$	2	Room temperature	Within 3	3	+85 $\pm 2$	30 $\pm 3$	4	Room temperature	Within 3
Conditions of 1 cycle																						
Step	Temperature (°C)	Duration (min)																				
1	-40 $\pm 3$	30 $\pm 3$																				
2	Room temperature	Within 3																				
3	+85 $\pm 2$	30 $\pm 3$																				
4	Room temperature	Within 3																				
17. Damp heat	Inductance change : Within $\pm 10\%$ No significant abnormality in appearance.			<p>BRC1608, BRL2012, BRC2016, BRL2518, BRL3225 Type :</p> <table border="1" style="margin-left: auto; margin-right: auto;"> <tbody> <tr> <td>Temperature</td> <td>60 <math>\pm 2</math> °C</td> </tr> <tr> <td>Humidity</td> <td>90~95% RH</td> </tr> <tr> <td>Time</td> <td>1000 hours.</td> </tr> </tbody> </table> <p>Recovery : At least 2hrs of recovery under the standard condition after the test, followed by the measurement within 48 hrs.</p> <p>NRH24, NR30/40/60/80, NRG40 Type :</p> <p>The test samples shall be soldered to the test board by the reflow. The test samples shall be placed in thermostatic oven set at specified temperature and humidity as shown in below table.</p> <table border="1" style="margin-left: auto; margin-right: auto;"> <tbody> <tr> <td>Temperature</td> <td>60 <math>\pm 2</math> °C</td> </tr> <tr> <td>Humidity</td> <td>90~95% RH</td> </tr> <tr> <td>Time</td> <td>500 <math>\pm 24</math> hour</td> </tr> </tbody> </table>	Temperature	60 $\pm 2$ °C	Humidity	90~95% RH	Time	1000 hours.	Temperature	60 $\pm 2$ °C	Humidity	90~95% RH	Time	500 $\pm 24$ hour						
Temperature	60 $\pm 2$ °C																					
Humidity	90~95% RH																					
Time	1000 hours.																					
Temperature	60 $\pm 2$ °C																					
Humidity	90~95% RH																					
Time	500 $\pm 24$ hour																					

Item	Specified Value			Test Method and Remarks																
	BRC1608, BRL2012, BRC2016, BRL2518, BRL3225 Type	NRH24, NR30/40/60/80, NRG40 Type	NR10050 Type																	
18.Loading under damp heat	Inductance change : Within $\pm 10\%$ No significant abnormality in appearance.			BRC1608,BRL2012,BRC2016,BRL2518,BRL3225Type : <table border="1"> <tr><td>Temperature</td><td>60<math>\pm 2^{\circ}\text{C}</math></td></tr> <tr><td>Humidity</td><td>90~95%RH</td></tr> <tr><td>Applied current</td><td>Rated current</td></tr> <tr><td>Time</td><td>1000hours.</td></tr> </table> Recovery : At least 2hrs of recovery under the standard condition after the test, followed by the measurement within 48 hrs.  NRH24, NR30/40/60/80, NRG40Type, NR10050 Type : The test samples shall be soldered to the test board by the reflow. The test samples shall be placed in thermostatic oven set at specified temperature and humidity and applied the rated current continuously as shown in below table. <table border="1"> <tr><td>Temperature</td><td>60<math>\pm 2^{\circ}\text{C}</math></td></tr> <tr><td>Humidity</td><td>90~95%RH</td></tr> <tr><td>Applied current</td><td>Rated current</td></tr> <tr><td>Time</td><td>500<math>\pm 2</math>hour</td></tr> </table>	Temperature	60 $\pm 2^{\circ}\text{C}$	Humidity	90~95%RH	Applied current	Rated current	Time	1000hours.	Temperature	60 $\pm 2^{\circ}\text{C}$	Humidity	90~95%RH	Applied current	Rated current	Time	500 $\pm 2$ hour
Temperature	60 $\pm 2^{\circ}\text{C}$																			
Humidity	90~95%RH																			
Applied current	Rated current																			
Time	1000hours.																			
Temperature	60 $\pm 2^{\circ}\text{C}$																			
Humidity	90~95%RH																			
Applied current	Rated current																			
Time	500 $\pm 2$ hour																			
19.Low temperature life test	Inductance change : Within $\pm 10\%$ No significant abnormality in appearance.			BRC1608,BRL2012,BRC2016,BRL2518,BRL3225Type : <table border="1"> <tr><td>Temperature</td><td>-40<math>\pm 2^{\circ}\text{C}</math></td></tr> <tr><td>Duration</td><td>1000hours</td></tr> </table> Recovery : At least 2hrs of recovery under the standard condition after the test, followed by the measurement within 48 hrs.  NRH24, NR30/40/60/80, NRG40Type, NR10050 Type : The test samples shall be soldered to the test board by the reflow. After that, the test samples shall be placed at test conditions as shown in below table. <table border="1"> <tr><td>Temperature</td><td>-40<math>\pm 3^{\circ}\text{C}</math></td></tr> <tr><td>Time</td><td>500<math>\pm 24</math>hour</td></tr> </table>	Temperature	-40 $\pm 2^{\circ}\text{C}$	Duration	1000hours	Temperature	-40 $\pm 3^{\circ}\text{C}$	Time	500 $\pm 24$ hour								
Temperature	-40 $\pm 2^{\circ}\text{C}$																			
Duration	1000hours																			
Temperature	-40 $\pm 3^{\circ}\text{C}$																			
Time	500 $\pm 24$ hour																			
20.High temperature life test	Inductance change : Within $\pm 10\%$ No significant abnormality in appearance.	/	Inductance change : Within $\pm 10\%$ No significant abnormality in appearance.	BRC1608,BRL2012,BRC2016,BRL2518,BRL3225Type : <table border="1"> <tr><td>Temperature</td><td>85<math>\pm 2^{\circ}\text{C}</math></td></tr> <tr><td>Duration</td><td>1000hours</td></tr> </table> Recovery : At least 2hrs of recovery under the standard condition after the test, followed by the measurement within 48 hrs.  NR10050 Type : <table border="1"> <tr><td>Temperature</td><td>105<math>\pm 3^{\circ}\text{C}</math></td></tr> <tr><td>Time</td><td>500<math>\pm 24</math>hour</td></tr> </table> Recovery : At least 2hrs of recovery under the standard condition after the test, followed by the measurement within 48 hrs.	Temperature	85 $\pm 2^{\circ}\text{C}$	Duration	1000hours	Temperature	105 $\pm 3^{\circ}\text{C}$	Time	500 $\pm 24$ hour								
Temperature	85 $\pm 2^{\circ}\text{C}$																			
Duration	1000hours																			
Temperature	105 $\pm 3^{\circ}\text{C}$																			
Time	500 $\pm 24$ hour																			
21.Loading at high temperature life test	/	Inductance change : Within $\pm 10\%$ No significant abnormality in appearance.	/	NRH24, NR30/40/60/80, NRG40Type : The test samples shall be soldered to the test board by the reflow soldering <table border="1"> <tr><td>Temperature</td><td>85<math>\pm 2^{\circ}\text{C}</math></td></tr> <tr><td>Applied current</td><td>Rated current</td></tr> <tr><td>Time</td><td>500<math>\pm 24</math>hour</td></tr> </table>	Temperature	85 $\pm 2^{\circ}\text{C}$	Applied current	Rated current	Time	500 $\pm 24$ hour										
Temperature	85 $\pm 2^{\circ}\text{C}$																			
Applied current	Rated current																			
Time	500 $\pm 24$ hour																			
22.Standard condition	Standard test condition : Unless otherwise specified, temperature is 20 $\pm 15\%$ and 65 $\pm 20\%$ of relative humidity. When there are question concerning measurement result : In order to provide correlation date, the test shall be condition of 20 $\pm 2^{\circ}\text{C}$ of temperature, 65 $\pm 5\%$ relative humidity. Inductance is in accordance with our measured value.																			

SMD Inductors

Stages	Precautions	Technical considerations
1.Circuit Design	<p>Operating environment,</p> <p>1.The products described in this specification are intended for use in general electronic equipment,(office supply equipment, telecommunications systems, measuring equipment, and household equipment). They are not intended for use in mission-critical equipment or systems requiring special quality and high reliability (traffic systems, safety equipment, aerospace systems, nuclear control systems and medical equipment including life-support systems,) where product failure might result in loss of life, injury or damage. For such uses, contact TAIYO YUDEN Sales Department in advance.</p>	
2.PCB Design	<p>Land pattern design</p> <p>1.Please refer to a recommended land pattern.</p>	<p>Surface Mounting</p> <ul style="list-style-type: none"> <li>Mounting and soldering conditions should be checked beforehand.</li> <li>Applicable soldering process to this products is reflow soldering only.</li> </ul>
3.Considerations for automatic placement	<p>Adjustment of mounting machine</p> <p>1.Excessive impact load should not be imposed on the products when mounting onto the PC boards.</p> <p>2.Mounting and soldering conditions should be checked beforehand.</p>	<p>1. When installing products, care should be taken not to apply distortion stress as it may deform the products.</p>
4.Soldering	<p>Reflow soldering</p> <p>1.Please contact any of our offices for a reflow soldering, and refer to the recommended condition specified.</p> <p>2.This products is reflow soldering only.</p> <p>3.Please do not add any stress to a product until it returns in normal temperature after reflow soldering.</p> <p>Lead free soldering</p> <p>1.When using products with lead free soldering, we request to use them after confirming of adhesion, temperature of resistance to soldering heat, soldering etc sufficiently.</p> <p>Recommended conditions for using a soldering iron: ( NR10050 type)</p> <p>Put the soldering iron on the land-pattern. Soldering iron's temperature - Below 350 °C Duration - 3 seconds or less The soldering iron should not directly touch the inductor.</p>	<p>1.If products are used beyond the range of the recommended conditions, heat stresses may deform the products, and consequently degrade the reliability of the products.</p> <p><b>[BRC1608, BRL2012, BRL2518, BRC2016, BRL3225Type]</b></p> <p>Recommended reflow condition (Pb free solder)</p> <p><b>[NRH24, NR30/40/60/80Type]</b></p> <p>Recommended reflow condition (Pb free solder)</p> <p><b>[NR10050Type]</b></p> <p>Recommended reflow condition (Pb free solder)</p>
5.Cleaning	<p>Cleaning conditions</p> <p>1.Washing by supersonic waves shall be avoided.</p>	<p>1.If washing by supersonic waves, supersonic waves may cause broken products.</p>
6.Handling	<p>Handling</p> <p>1.Keep the product away from all magnets and magnetic objects. Breakaway PC boards (splitting along perforations)</p> <p>1.When splitting the PC board after mounting product, care should be taken not to give any stresses of deflection or twisting to the board.</p> <p>2.Board separation should not be done manually, but by using the appropriate devices.</p> <p>Mechanical considerations</p> <p>1.Please do not give the product any excessive mechanical shocks.</p> <p>2.Please do not add any shock and power to a product in transportation.</p> <p>Pick-up pressure</p> <p>1.Please do not push to add any pressure to a winding part. Please do not give any shock and push into a ferrite core exposure part.</p> <p>Packing</p> <p>1.Please avoid accumulation of a packing box as much as possible.</p>	<p>1.Planning pattern configurations and the position of products should be carefully performed to minimize stress.</p> <p>1.There is a case to be damaged by a mechanical shock.</p> <p>2.There is a case to be broken by the handling in transportation.</p> <p>1.Damage and a characteristic can vary with an excessive shock or stress.</p> <p>1.There is a case that transformation and a product of tape are damaged by accumulation of a packing box.</p>
7.Storage conditions	<p>Storage</p> <p>1.To maintain the solderability of terminal electrodes and to keep the packing material in good condition, temperature and humidity in the storage area should be controlled.</p> <p>•Recommended conditions</p> <p>Ambient temperature 0~40°C Humidity Below 70% RH</p> <p>The ambient temperature must be kept below 30°C. Even under ideal storage conditions, solderability of products electrodes may decrease as time passes. For this reason, product should be used within 6 months from the time of delivery. In case of storage over 6 months, solderability shall be checked before actual usage.</p>	<p>1.Under a high temperature and humidity environment, problems such as reduced solderability caused by oxidation of terminal electrodes and deterioration of taping/packaging materials may take place.</p>