

Typical Applications

The HMC6187LP4E is ideal for:

- Point-to-Point Radio
- Point-to-Multi-Point Radio
- EW & ECM Subsystems
- Ka-Band Radar & VSAT
- Test Equipment

Functional Diagram

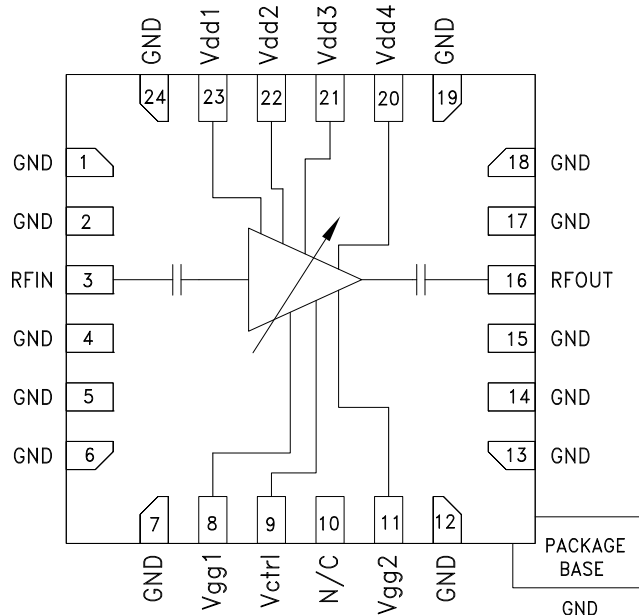

Features

- Wide Gain Control Range: 13 dB
- Single Control Voltage
- Output IP3 @ Max Gain: +31 dBm
- Output P1dB: +24 dBm
- No External Matching
- 24 Lead 4x4 mm SMT Package: 16 mm²

General Description

The HMC6187LP4E is a GaAs MMIC pHEMT analog variable gain amplifier and/or driver amplifier which operates between 27 and 31.5 GHz and is ideal for microwave radio applications. The amplifier provides up to 19 dB of gain, output P1dB of up to +24 dBm, and up to +31 dBm of output IP3 at maximum gain, while requiring 230 mA from a +5V supply. A gain control voltage (Vctrl) is provided to allow variable gain control up to 13 dB. Gain flatness is excellent making the HMC6187LP4E ideal for EW, ECM and radar applications. The HMC6187LP4E is housed in a RoHS compliant 4 x 4 mm plastic QFN leadless package and is compatible with high volume surface mount manufacturing.

Electrical Specifications, $T_A = +25^\circ\text{C}$, $V_{dd1, 2, 3, 4} = 5\text{V}$, $V_{ctrl} = -4.5\text{V}$, $I_{dd} = 230\text{ mA}$ ^[1]

Parameter	Min.	Typ.	Max.	Units
Frequency Range		27 - 31.5		GHz
Gain ^[2]	16	19		dB
Gain Flatness		±0.5		dB
Gain Variation Over Temperature		0.02		dB/ °C
Gain Control Range		13		dB
Noise Figure ^[2]		4.5		dB
Input Return Loss		12		dB
Output Return Loss		15		dB
Output Power for 1 dB Compression (P1dB) ^[2]	21	24		dBm
Saturated Output Power (Psat) ^[2]		25		dBm
Output Third Order Intercept (IP3) ^[2]		31		dBm
Total Supply Current (Idd)		230		mA

^[1] Set Vctrl = -4.5V and then adjust Vgg1, 2 between -2V to 0V to achieve Idd = 230 mA typical.

^[2] Board loss subtracted out.

Gain vs. Control Voltage Range

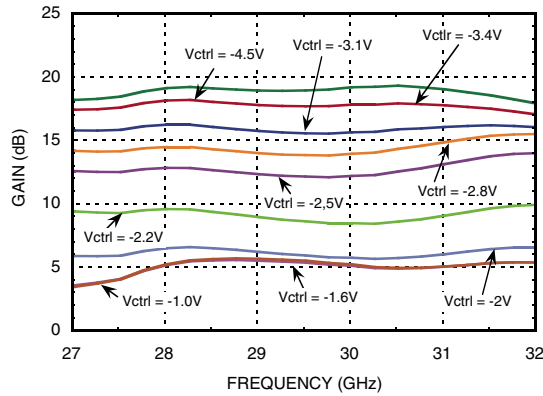

Gain vs. Control Voltage

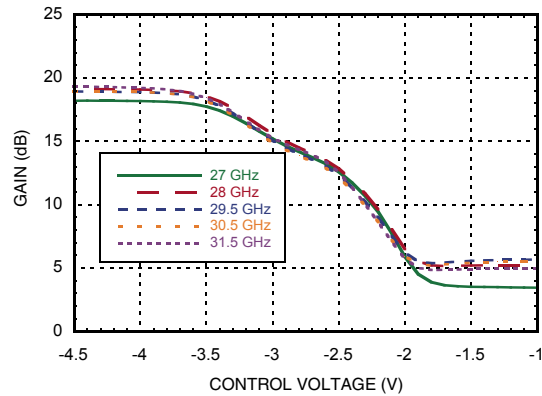

Broadband Gain & Return Loss

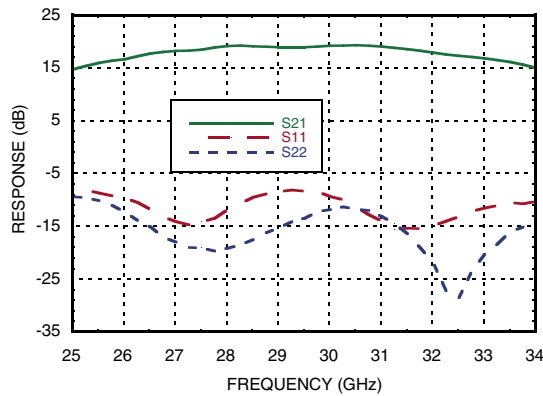

Gain vs. Temperature

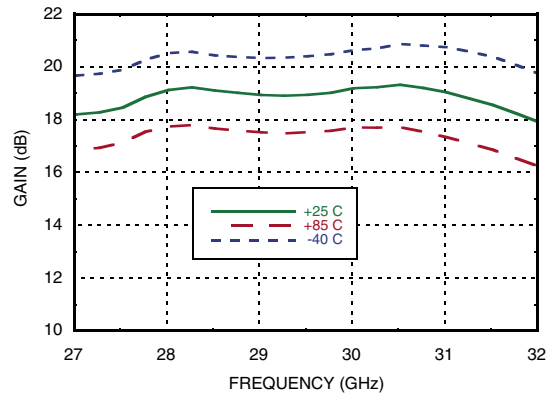

Input Return Loss vs. Temperature

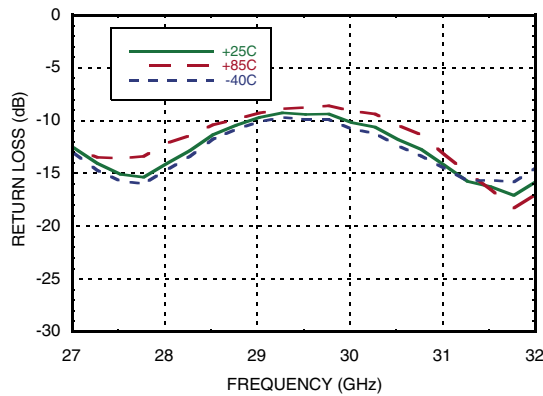

Output Return Loss vs. Temperature

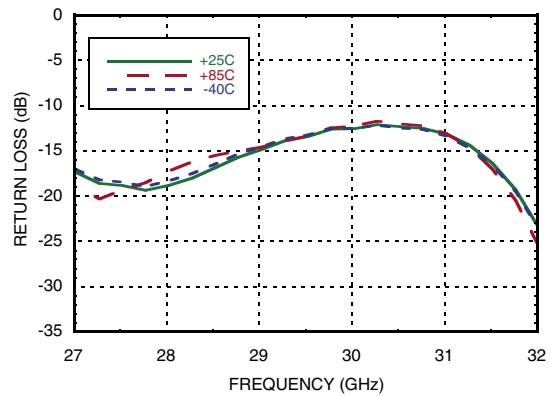



VARIABLE GAIN AMPLIFIER 27 - 31.5 GHz

VARIABLE GAIN AMPLIFIER - SMT

**Input Return Loss @
Control Voltage Extreme**

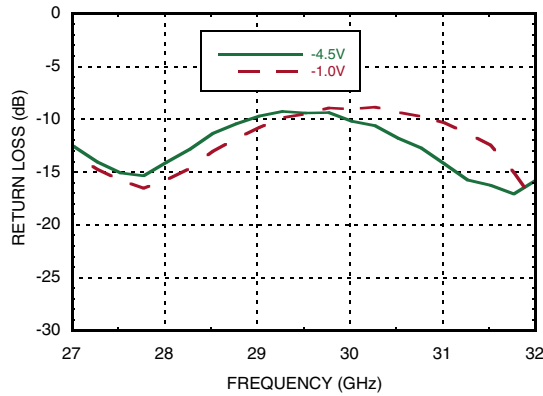

**Output Return Loss @
Control Voltage Extreme**

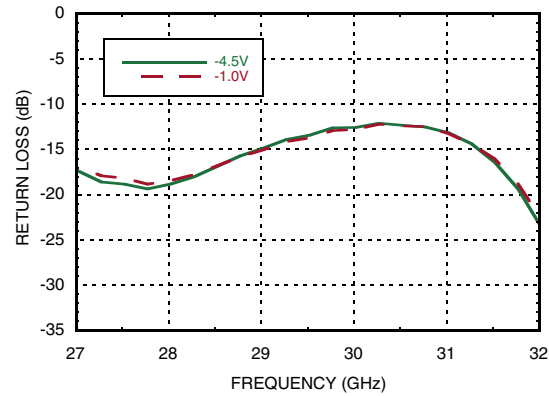

Noise Figure vs. Temperature

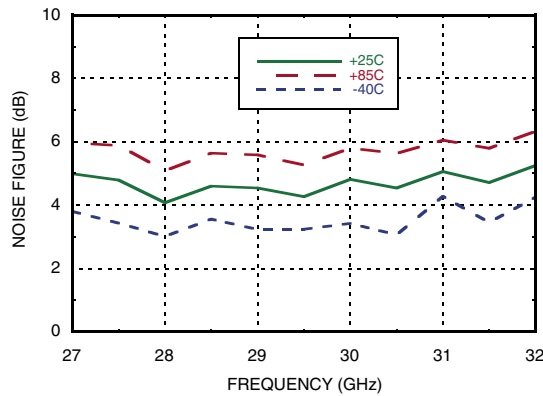

Noise Figure vs. Control Voltage

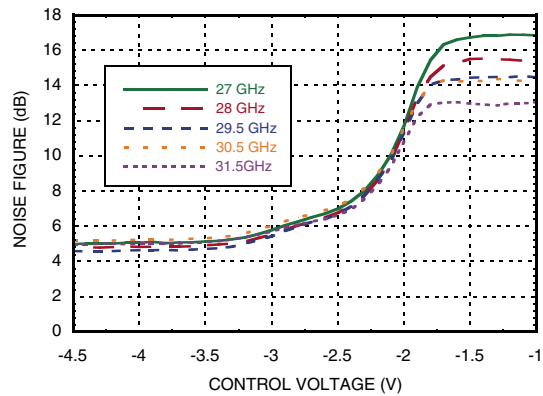

P1dB vs. Temperature, Vctrl = -4.5V

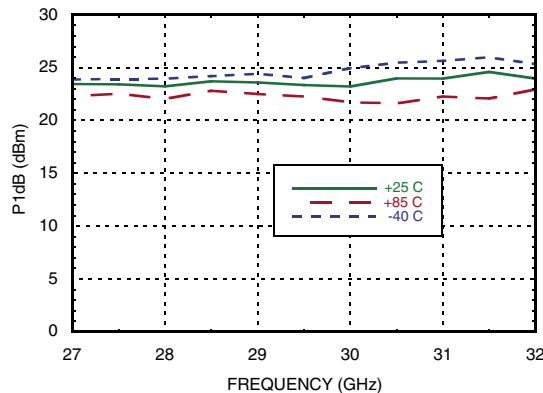

Psat vs. Temperature, Vctrl = -4.5V

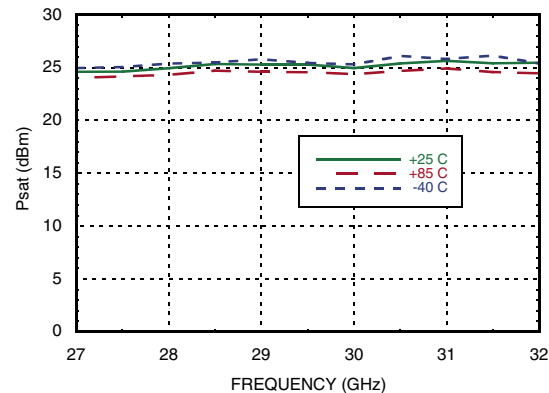

Reverse Isolation vs. Temperature

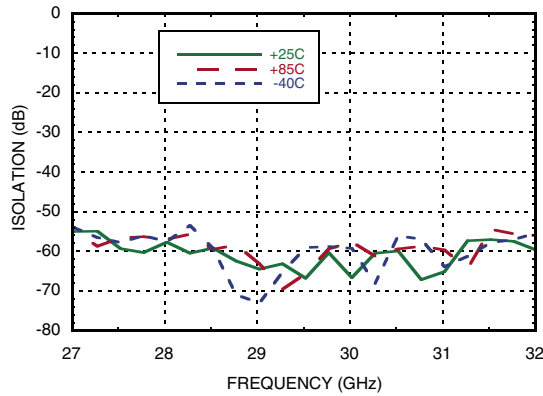

Output IP3 vs. Temperature, Vctrl=-4.5V

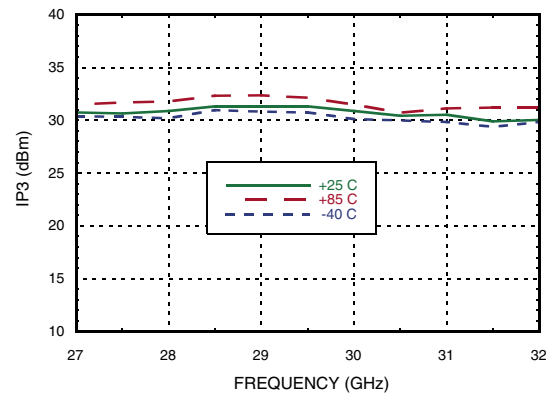

IP3 and Gain @ 27 GHz Pin = -7 dBm

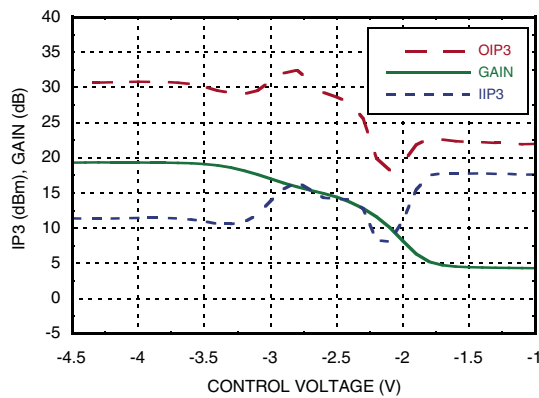

IP3 and Gain @ 29.5 GHz Pin = -7 dBm

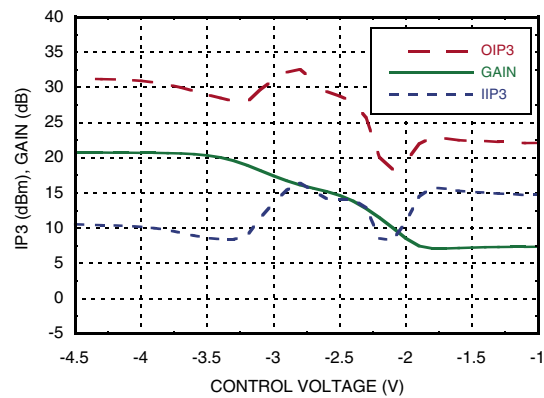

IP3 and Gain @ 31.5 GHz Pin = -7 dBm

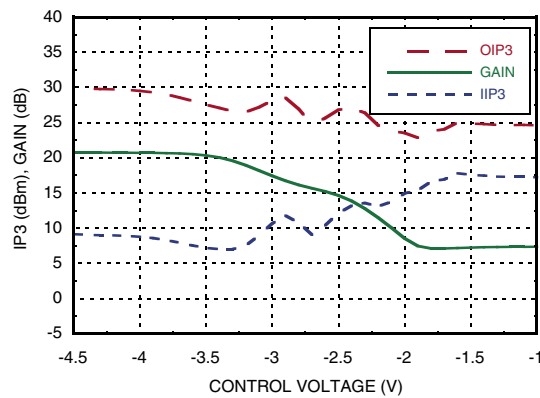

Pin Descriptions

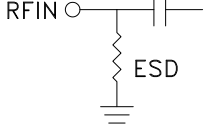
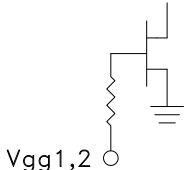
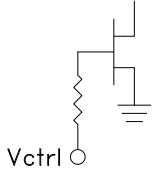
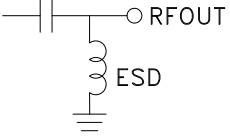
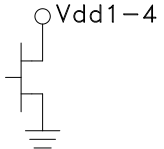
Pin Number	Function	Description	Interface Schematic
1, 2, 4, 5, 6, 7, 12, 13, 14, 15, 17, 18, 19, 24	GND	These pins and exposed ground paddle must be connected to RF/DC ground.	
3	RFIN	This pin is AC coupled and matched to 50 Ohms.	
8, 11	Vgg1, 2	Adjust voltage to achieve typical I _{dd} . Please follow "MMIC Amplifier Biasing Procedure" application note.	
9	Vctrl	Gain control Voltage for the amplifier. See assembly diagram for required external components.	
10	NC	The pins are not connected internally; however all data shown herein was measured with these pins connected to RF/DC ground externally.	
16	RFOUT	This pad is AC coupled and matched to 50 Ohms.	
20, 21, 22, 23	Vdd4, 3, 2, 1	Drain Bias Voltage for the amplifier. See assembly diagram for required external components	

Application Circuit

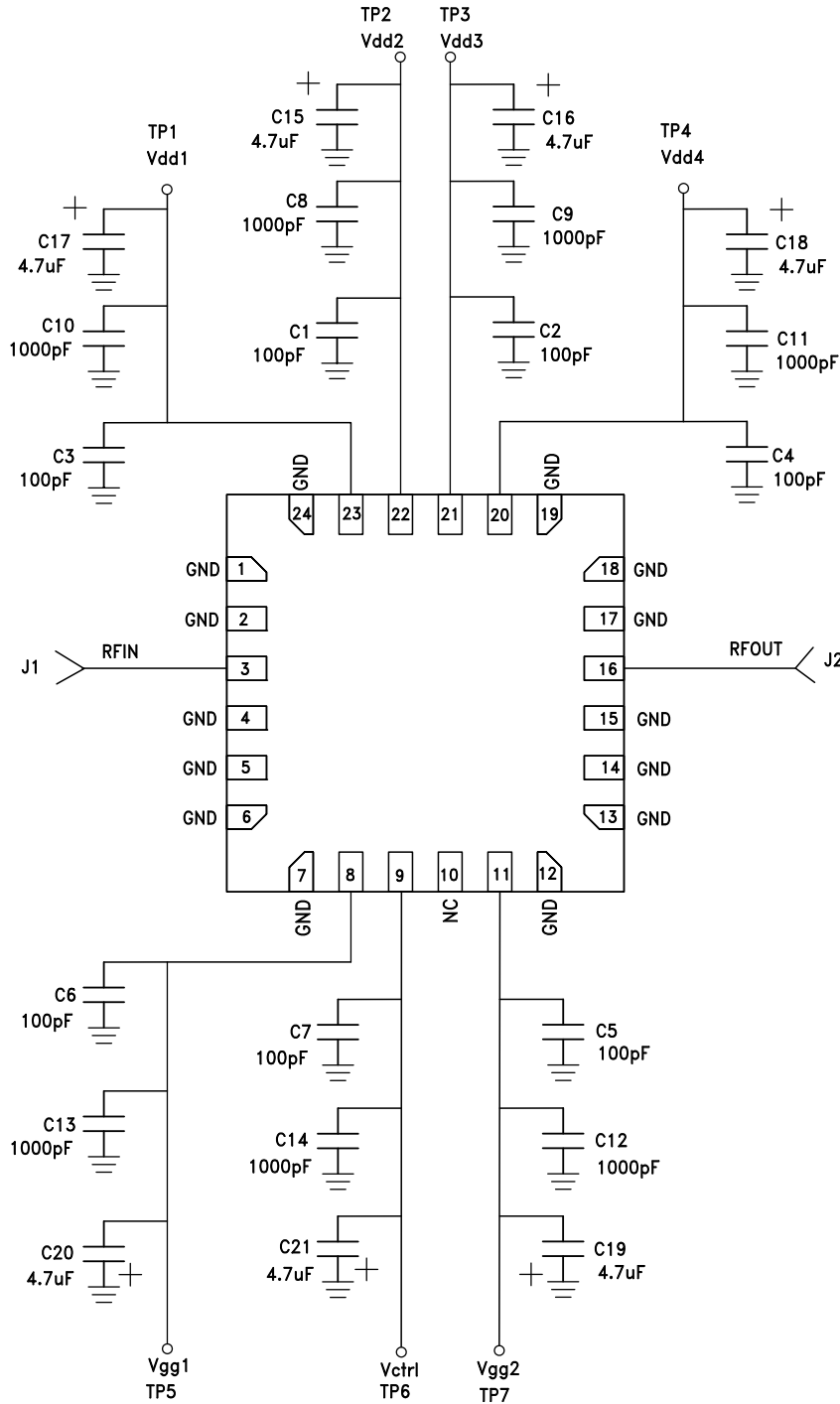

Evaluation PCB

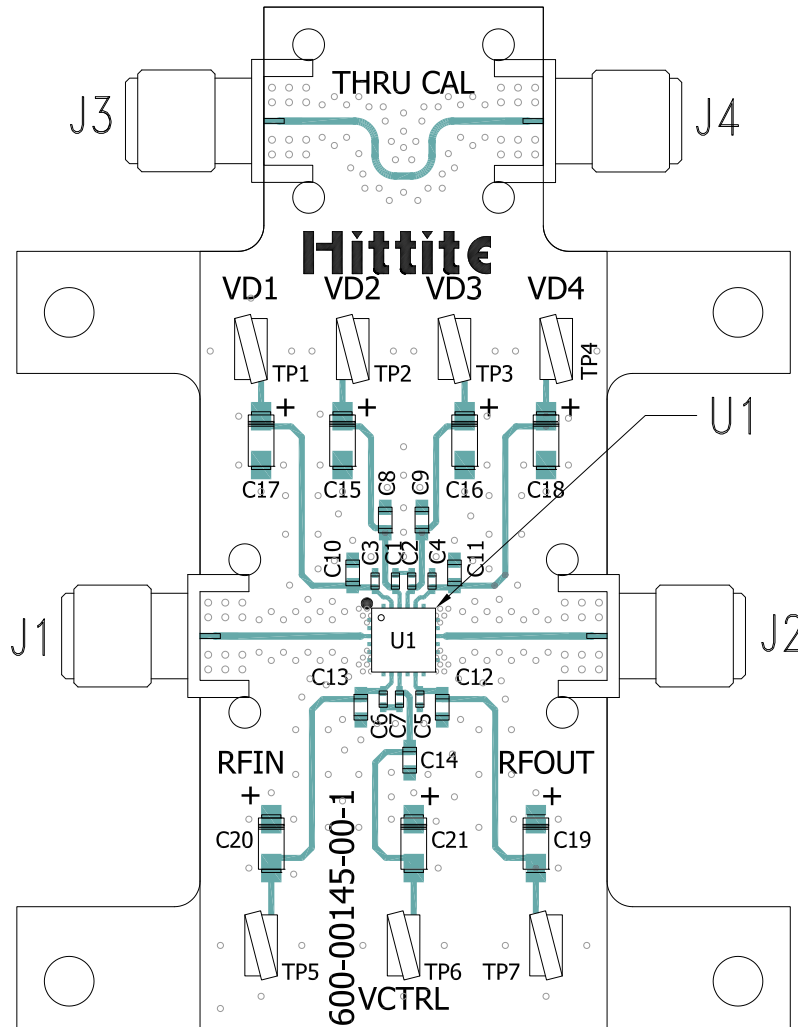

List of Materials for Evaluation PCB EVAL01-HMC6187LP4E [1]

Item	Description
J1 - J4	PCB Mount K Connectors
TP1 - TP7	DC Pin
C1 - C7	100 pF Capacitor, 0402 Pkg.
C8 - C14	10,000 pF Capacitor, 0603 Pkg.
C15 - C21	4.7 μF Capacitor, CASE A
U1	HMC6187LP4E Variable Gain Amplifier
PCB [2]	600-00145-00 Evaluation PCB

[1] Reference this number when ordering complete evaluation PCB

[2] Circuit Board Material: Arlon 25FR

The circuit board used in the application should use RF circuit design techniques. Signal lines should have 50 Ohm impedance while the package ground leads and exposed paddle should be connected directly to the ground plane similar to that shown. A sufficient number of via holes should be used to connect the top and bottom ground planes. The evaluation circuit board shown is available from Hittite upon request.