

## Type MRS Series

### Key Features

- Suitable for tight spaces
- High precision thin film
- Wide value range
- Lower placement costs
- Range of stabilities
- Low cost in volume
- High reliability design
- RoHS compliant component compatible with lead (Pb) free soldering techniques

### Applications

- Voltage divider
- Feedback circuits
- Signal conditioning

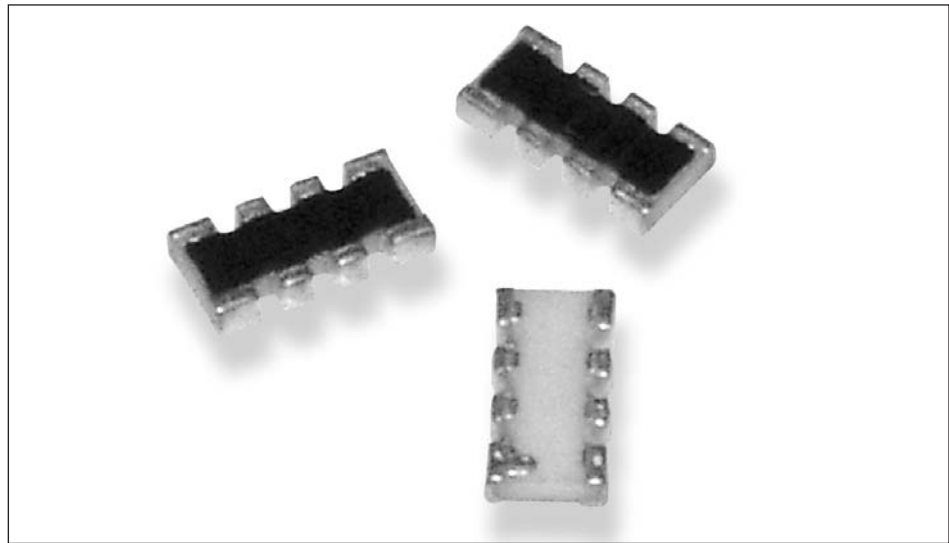

The MRS series is an entirely new chip network utilising nickel chrome sputtering on high purity alumina. This network has been designed for high volume applications and is offered with 4 isolated resistors on a single substrate (4 x 0603 resistors) at 0.1% with convex terminals. A wide value range and alternative TCRs (Temperature Coefficient of Resistance) make this a most versatile resistor solution.

### Characteristics - Electrical

Rated Power at 70°C:	0.0625W		
Resistance Range Ω Min:	100		100
Resistance Range Ω Max:	2K0		33K
Resistance Tolerance:	±0.1%, ±0.5%, ±1%		
Temperature Coefficient of Resistance (ppm/°C):	±10	±15	±25 ±50
Selection Series:	E24		
Maximum Operating Voltage:	50V		
Maximum Overload Voltage:	100V		
Operating Temperature Range:	-55 to +155°C		

Operating Voltage= $\sqrt{P \cdot R}$  or max. operating voltage listed above, whichever is lower  
 Overload Voltage= $2.5 \cdot \sqrt{P \cdot R}$  or max. overload voltage listed above, whichever is lower

### Characteristics - Environmental

Item	Requirement		Test Method
	Tol. ≤ 0.25%	Tol. > 0.25%	
Temperature Coefficient of Resistance (T.C.R.):	As specified		MIL-STD-202F Method 304 +25/-55/+25/+125/+25°C
Short Time Overload:	ΔR±0.25%	ΔR±0.5%	JIS-C-5201-1 5.5 RCWV*2.5 or max. overload voltage for 5 seconds
Insulation Resistance:	1000MΩ		MIL-STD-202F Method 302 Apply 100VDC for 1 minute
Endurance:	ΔR±0.25%	ΔR±0.5%	MIL-STD-202F Method 108A 70±2°C, max. working voltage for 1000hrs with 1.5hrs "ON" and 0.5 hrs "OFF"
Damp Heat with Load:	ΔR±0.25%	ΔR±0.5%	MIL-STD-202F Method 103B 40±2°C, 90~95% R.H. max. working voltage for 1000hrs with 1.5hrs "ON" and 0.5 hrs "OFF"
Bending Strength:	ΔR±0.25%	ΔR±0.5%	JIS-C-5201-1 6.1.4 Bending amplitude 3mm for 10 seconds
Solderability:	95% min. coverage		MIL-STD-202F Method 208H 245±5°C for 3 seconds
Resistance to Soldering Heat:	ΔR±0.25%	ΔR±0.5%	MIL-STD-202F Method 210E 260±5°C for 10 seconds
Dielectric Withstand Voltage:	100V		MIL-STD-202F Method 301 max. overload voltage for 1 minute
Thermal Shock:	ΔR±0.25%	ΔR±0.5%	MIL-STD-202F Method 107G -55°C ~150°C, 100 cycles
Low Temperature Operation:	ΔR±0.25%	ΔR±0.5%	JIS-C-5201-1 7.1 1 hour, -65°C, followed by 45 minutes of RCWV

Storage Temperature: 25±3°C; Humidity < 80%RH

## Type MRS Series

### Derating Curve

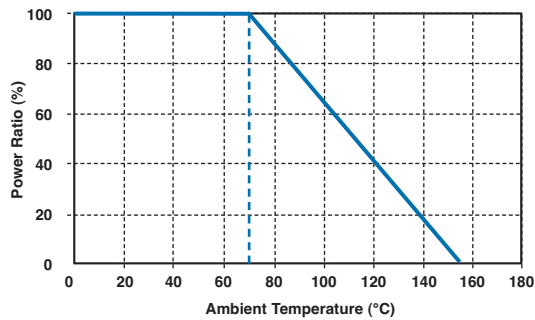

### Dimensions

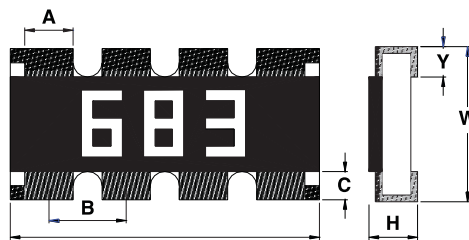

Type	No. of Resistors	Dimension							Weight (g) (1000 pcs)
		L	W	H	A	B	C	Y	
MRS	4	3.20 ±0.15	1.60 ±0.15	0.55 ±0.10	0.50 ±0.15	0.80 ±0.05	0.30 ±0.15	0.30 ±0.15	8.22

### Construction

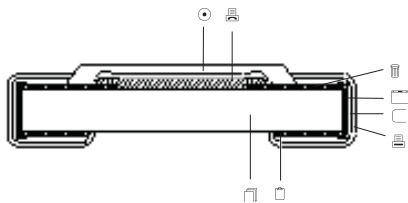

	Alumina Substrate		Barrier Layer (Ni)
	Bottom Electrode (Ag)		External Electrode (Sn)
	Top Electrode (Ag-Pd)		Resistor Layer (NiCr)
	Edge Electrode (Ag)		Overcoat (Epoxy)

### Recommend Land Pattern

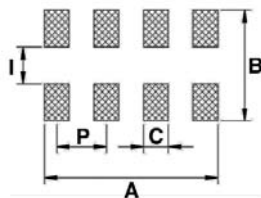

Type	A	B	C	I	P
MRS	2.85	3.10	0.45	0.80	0.80

### Circuit Diagram

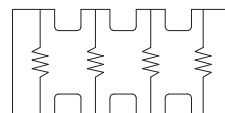

## Type MRS Series

### Paper Tape Specification

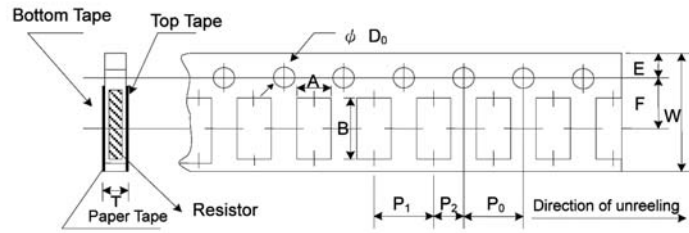

Type	A	B	W	E	F	P <sub>0</sub>	P <sub>1</sub>	P <sub>2</sub>	øD <sub>0</sub>	T
MRS	1.95 ±0.1	3.50 ±0.1	8.0 ±0.2	1.75 ±0.1	3.5 ±0.05	4.0 ±0.1	4.0 ±0.05	2.0 ±0.05	1.5 +0.1/-0	0.85 ±0.1

### Packaging

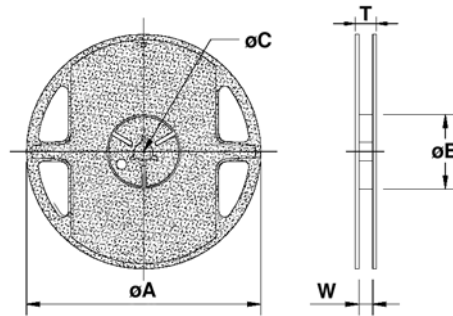

Type	Packaging-Quantity	Tape Width	Reel Diameter	øA	øB	øC	W	T
MRS	Paper-5K	8mm	7 inch	178.5 ±1.5	60 +1/-0	13.0 ±0.2	9.0 ±0.5	12.5 ±0.5

### Marking

Type	100R	2K2	0K	22K	33K
MRS	1000	2201	1002	2202	3302

### How to Order

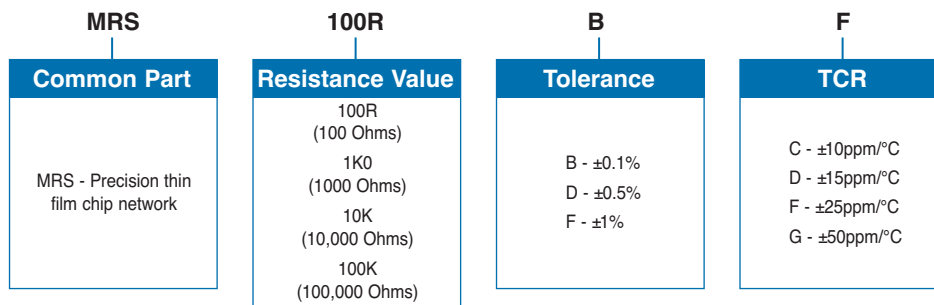

TE Connectivity, TE connectivity (logo) and TE (logo) are trademarks.  
Other logos, product and Company names mentioned herein may be trademarks of their respective owners.

While TE has made every reasonable effort to ensure the accuracy of the information in this datasheet, TE does not guarantee that it is error-free, nor does TE make any other representation, warranty or guarantee that the information is accurate, correct, reliable or current. TE reserves the right to make any adjustments to the information contained herein at any time without notice. TE expressly disclaims all implied warranties regarding the information contained herein, including, but not limited to, any implied warranties of merchantability or fitness for a particular purpose. The dimensions in this datasheet are for reference purposes only and are subject to change without notice. Specifications are subject to change without notice. Consult TE for the latest dimensions and design specifications.