

VI TELEFILTER**Filter specification****TFS 433Z****1/5****Measurement condition**

Ambient temperature:	23	°C
Input power level:	0	dBm
Terminating impedance: *		
Input:	113 Ω 5.7 pF	
Output:	113 Ω 5.7 pF	

Characteristics**Remark:**

The reference level for the relative attenuation a_{rel} of the TFS 433Z is the minimum of the pass band attenuation a_{min} . The minimum of the pass band attenuation a_{min} is defined as the insertion loss a_e . The centre frequency f_c is the arithmetic mean value of the upper and lower frequencies at the 3 dB filter attenuation level relative to the insertion loss a_e . The nominal frequency f_N is fixed at 433,92 MHz without any tolerance. The given values for both the relative attenuation a_{rel} and the group delay ripple have to be achieved at the frequencies given below even if the centre frequency f_c is shifted due to the temperature coefficient of frequency TC_f in the operating temperature range and due to a production tolerance for the centre frequency f_c .

D a t a		typ. value		tolerance / limit		
Insertion loss (reference level)	$a_e = a_{min}$	2,2	dB	max.	3,0	dB
		-			-	
Nominal frequency	f_N	-			433,92	MHz
Centre frequency	f_c	433,92	MHz		-	
Bandwidth	BW					
3 dB		695	kHz	min.	640	kHz
		-		max.	760	kHz
Relative attenuation	a_{rel}					
433,76 MHz ... 434,08 MHz		0,55	dB	max.	2,0	dB
433,74 MHz ... 434,10 MHz		0,64	dB	max.	3,0	dB
433,70 MHz ... 434,14 MHz		0,65	dB	max.	6,0	dB
10,00 MHz ... 414,00 MHz		60	dB	min.	53	dB
414,00 MHz ... 424,50 MHz		49	dB	min.	46	dB
424,50 MHz ... 431,72 MHz		47	dB	min.	31	dB
431,72 MHz ... 432,12 MHz		50	dB	min.	39	dB
432,12 MHz ... 433,10 MHz		35	dB	min.	8	dB
434,92 MHz ... 442,00 MHz		13	dB	min.	10	dB
442,00 MHz ... 550,00 MHz		44	dB	min.	36	dB
550,00 MHz ... 700,0 MHz		59	dB	min.	53	dB
700,00 MHz ... 805,00 MHz		43	dB	min.	40	dB
805,00 MHz ... 1000,00 MHz		72	dB	min.	53	dB
Input power level		-		max.	10	dBm
Permissible DC voltage		-		max.	6	V
Operable temperature range		-			- 45 °C ... + 120 °C	
Operating temperature range	OTR	-			- 40 °C ... + 95 °C	
Storage temperature range		-			- 45 °C ... + 130 °C	
Frequency inversion temperature	T_0	30	°C			
Temperature coefficient of frequency	TC_f **	- 0.033	ppm/K ²			

*) The terminating impedances depend on parasitics and q-values of matching elements and the board used, and are to be understood as reference values only. Should there be additional questions, do not hesitate to ask for an application note or contact our design team.

**) $\Delta f(\text{Hz}) = TC_f(\text{ppm/K}^2) \times (T_0 - T)^2 \times f_{CAT}(\text{MHz})$.

Generated:**Checked / Approved:**

Tele Filter GmbH
Potsdamer Straße 18
D 14 513 TELTOW / Germany
Tel: (+49) 3328 4784-0 / Fax: (+49) 3328 4784-30
E-Mail: tft@telefilter.com

VI TELEFILTER reserves the right to make changes to the product(s) and/or information contained herein without notice. No liability is assumed as a result of their use or application. No rights under any patent accompany the sale of any such product(s) or information.

Filter characteristic

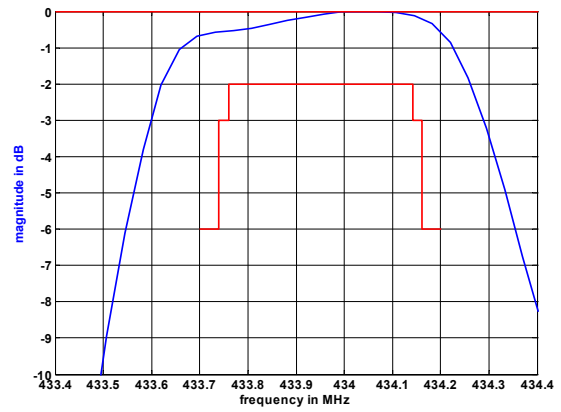
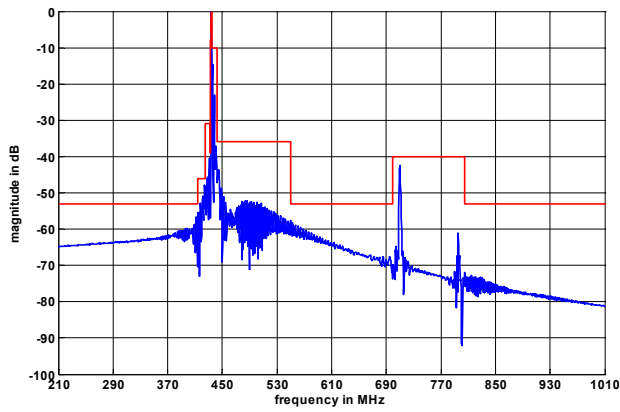

Construction and pin connection

(All dimensions in mm)

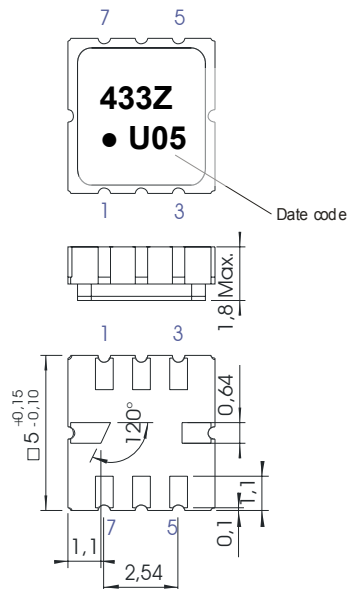

- 1 Input
- 2 Ground
- 3 Ground
- 4 Ground
- 5 Output
- 6 Ground
- 7 Ground
- 8 Ground

Date code: Year + week
 U 2006
 V 2007
 W 2008
 ...

50 Ω Test circuit

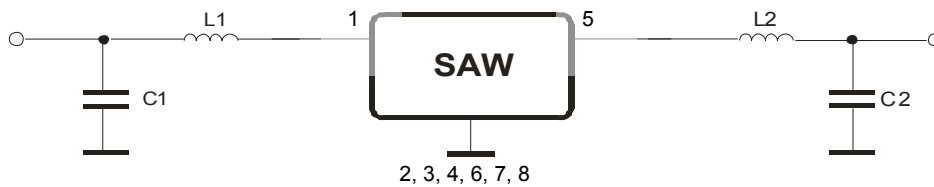

Tele Filter GmbH
 Potsdamer Straße 18
 D 14 513 TELTOW / Germany
 Tel: (+49) 3328 4784-0 / Fax: (+49) 3328 4784-30
 E-Mail: tft@telefilter.com

VI TELEFILTER reserves the right to make changes to the product(s) and/or information contained herein without notice. No liability is assumed as a result of their use or application. No rights under any patent accompany the sale of any such product(s) or information.

Stability characteristics, reliability

After the following tests the filter shall meet the whole specification:

1. Shock: 500g, 1 ms, half sine wave, 3 shocks each plane;
DIN IEC 68 T2 - 27
2. Vibration: 10 Hz to 500 Hz, 0,35 mm or 5 g respectively, 1 octave per min, 10 cycles per plan, 3 plans;
DIN IEC 68 T2 - 6
3. Change of temperature: -55 °C to 125°C / 30 min. each / 10 cycles
DIN IEC 68 part 2 – 14 Test N
4. Resistance to solder heat (reflow): reflow possible: twice max.;
for temperature conditions refer to the attached "Air reflow temperature conditions" on page 4;

This filter is RoHS compliant (2002/95/EG, 2005/618/EG)

Packing

Tape & Reel: IEC 286 – 3, with exception of value for N and minimum bending radius;
tape type II, embossed carrier tape with top cover tape on the upper side;

max. pieces of filters per reel:	3000
reel of empty components at start:	min. 300 mm
reel of empty components at start including leader:	min. 500 mm
trailer:	min. 300 mm

Tape (all dimensions in mm)

- W : 12,00 ± 0,3
- Po : 4,00 ± 0,1
- Do : 1,50 +0,1/-0
- E : 1,75 ± 0,1
- F : 5,50 ± 0,05
- G(min) : 0,75
- P2 : 2,00 ± 0,05
- P1 : 8,00 ± 0,1
- D1(min) : 1,50
- Ao : 5,30 ± 0,1
- Bo : 5,30 ± 0,1
- Ct : 9,5 ± 0,1

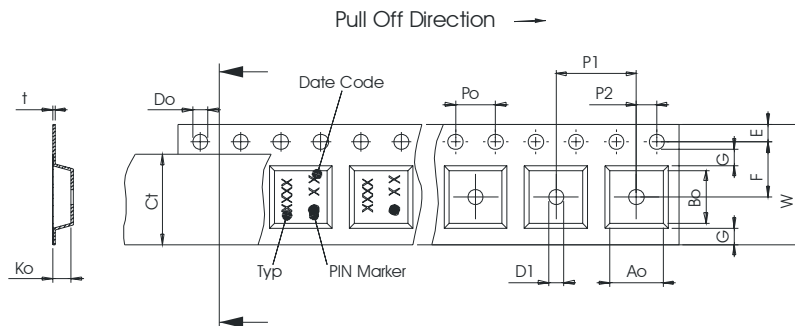

Reel (all dimensions in mm)

- A : 330
- W1 : 12,4 +2/-0
- W2(max) : 18,4
- N(min) : 50
- C : 13,0 +0,5/-0,2

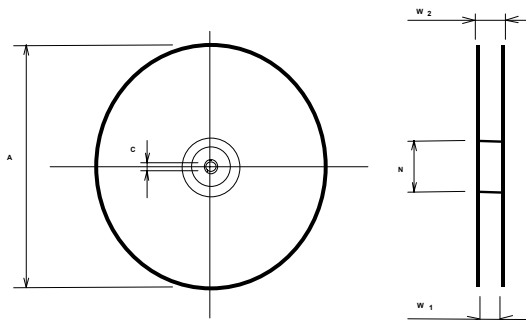

The minimum bending radius is 45 mm.

Tele Filter GmbH
Potsdamer Straße 18
D 14 513 TELTOW / Germany
Tel: (+49) 3328 4784-0 / Fax: (+49) 3328 4784-30
E-Mail: tft@telefilter.com

VI TELEFILTER reserves the right to make changes to the product(s) and/or information contained herein without notice. No liability is assumed as a result of their use or application. No rights under any patent accompany the sale of any such product(s) or information.

Air reflow temperature conditions

Conditions	Exposure
Average ramp-up rate (30°C to 217°C)	less than 3°C/second
> 100°C	between 300 and 600 seconds
> 150°C	between 240 and 500 seconds
> 217°C	between 30 and 150 seconds
Peak temperature	max. 260°C
Time within 5°C of actual peak temperature	between 10 and 30 seconds
Cool-down rate (Peak to 50°C)	less than 6°C/second
Time from 30°C to Peak temperature	no greater than 300 seconds

Chip-mount air reflow profile

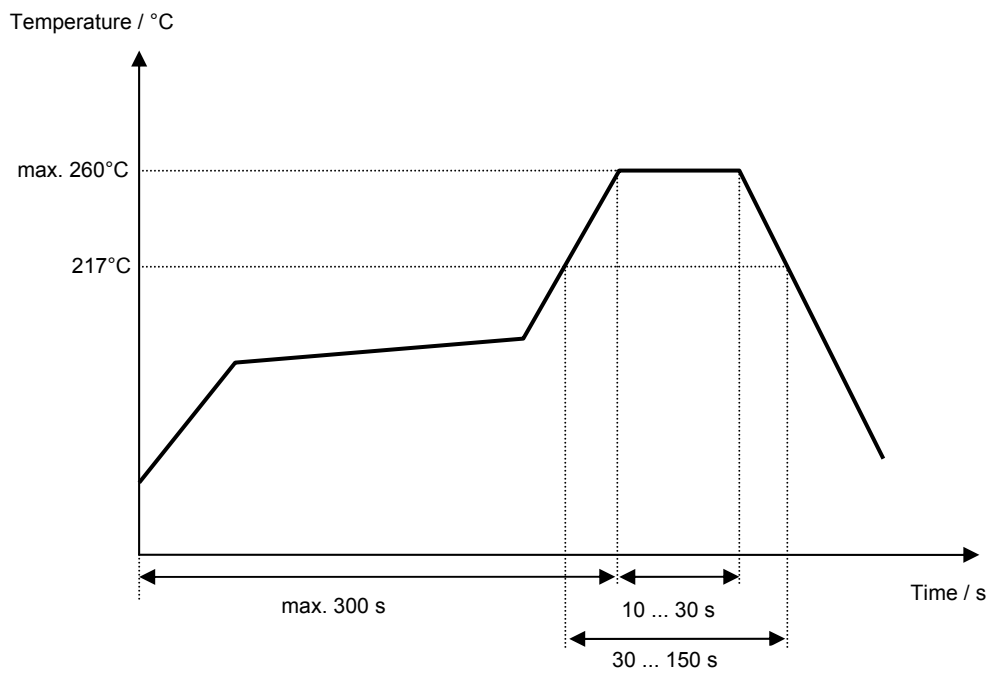

VI TELEFILTER**Filter specification****TFS 433Z****5/5****History**

Version	Reason of Changes	Name	Date
1.0	- Generation of development specification	Channaa	25.01.2006
1.1	- Add typical values, change limit of attenuation - add filter characteristic, add test circuit - Generation of filter specification	Channaa	03.02.2006

Tele Filter GmbH
Potsdamer Straße 18
D 14 513 TELTOW / Germany
Tel: (+49) 3328 4784-0 / Fax: (+49) 3328 4784-30
E-Mail: tft@telefilter.com

VI TELEFILTER reserves the right to make changes to the product(s) and/or information contained herein without notice. No liability is assumed as a result of their use or application. No rights under any patent accompany the sale of any such product(s) or information.