



TDA7566

4x40W multifunction quad power amplifier
with built-in diagnostics features

Features

- DMOS power output
- High output power capability 4x25W/4Ω @ 14.4V, 1KHZ, 10% THD, 4x40W max. power
- Max. output power 4x60W/2Ω
- Full I²C bus driving:
 - St-by
 - Independent front/rear soft play/mute
 - Selectable gain 26dB - 12dB
 - I²C bus digital diagnostics
- Full fault protection
- DC offset detection
- Four independent short circuit protection
- Clipping detector (1%/10%)
- ESD protection

Description

The TDA7566 is a new BCD technology QUAD BRIDGE type of car radio amplifier in Flexiwatt25 package specially intended for car radio applications.

www.DataSheet4U.com

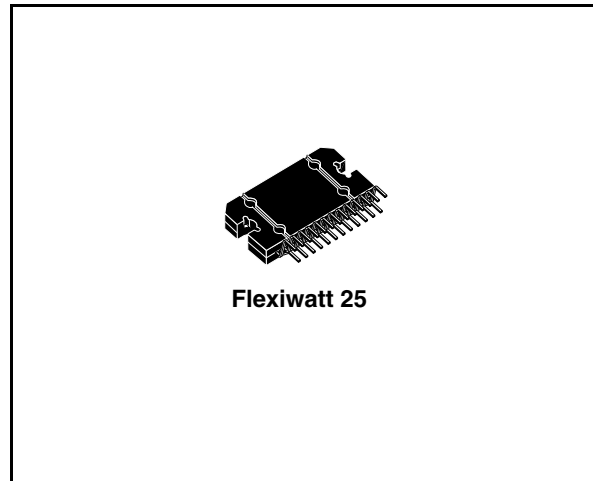

Thanks to the DMOS output stage the TDA7566 has a very low distortion allowing a clear powerful sound.

This device is equipped with a full diagnostics array that communicates the status of each speaker through the I²C bus.

The possibility to control the configuration and behaviour of the device by means of the I²C bus makes TDA7566 a very flexible machine.

Order codes

Part number	Package	Packing
TDA7566	Flexiwatt 25	Tube

Contents

1	Block diagram and application & test circuit	5
1.1	Block diagram	5
1.2	Application and test circuit	5
2	Pin description	6
3	Electrical specifications	7
3.1	Absolute maximum ratings	7
3.2	Thermal data	7
3.3	Electrical characteristics	7
3.4	Electrical characteristics curves	10
4	Diagnostics functional description	12
4.1	Turn-on diagnostic	12
4.2	Permanent diagnostics	14
4.3	Output DC offset detection	15
4.4	AC diagnostic	15
4.5	Multiple faults	16
4.6	Faults availability	17
4.7	I2C Programming/reading sequence	17
5	I2C Bus interface	19
5.1	Data Validity	19
5.2	Start and Stop Conditions	19
5.3	Byte Format	19
5.4	Acknowledge	19
6	Software specifications	21
7	Examples of bytes sequence	25
8	Package informations	26
9	Revision history	27

List of tables

Table 1.	Absolute maximum ratings	7
Table 2.	Thermal data	7
Table 3.	Electrical characteristics	7
Table 4.	Double Fault Table for Turn On Diagnostic	17
Table 5.	Chip Address:	21
Table 6.	IB1	21
Table 7.	IB2	21
Table 8.	DB1	22
Table 9.	DB2	22
Table 10.	DB3	23
Table 11.	DB4	24
Table 12.	Document revision history	27

List of figures

Figure 1.	Block diagram	5
Figure 2.	Application and test circuit	5
Figure 3.	Pin connection (top view)	6
Figure 4.	Quiescent current vs. Supply voltage	10
Figure 5.	Output power vs. supply voltage (4 Ω).	10
Figure 6.	Output power vs. supply voltage (2 Ω).	10
Figure 7.	Distortion vs. output power (4 Ω).	10
Figure 8.	Distortion vs. output power (2 Ω).	10
Figure 9.	Distortion vs. frequency (4 Ω)	10
Figure 10.	Distortion vs. frequency (2 Ω)	11
Figure 11.	Crosstalk vs. frequency	11
Figure 12.	Supply voltage rejection vs. frequency	11
Figure 13.	Power Dissipation & Efficiency vs. Output Power (4W, SINE)	11
Figure 14.	Power Dissipation vs. Average Output Power (Audio Program Simulation, 4W).	11
Figure 15.	Power Dissipation vs. Average Output Power (Audio Program Simulation, 2W).	11
Figure 16.	Turn - On diagnostic: working principle	12
Figure 17.	SVR and Output behaviour (CASE 1: without turn-on diagnostic)	13
Figure 18.	SVR and Output pin behaviour (CASE 2: with turn-on diagnostic).	13
Figure 19.	Thresholds for SHORT TO GND/ V_S	13
Figure 20.	Thresholds for SHORT ACROSS THE SPEAKER/OPEN SPEAKER	14
Figure 21.	Thresholds for Line-Drivers	14
Figure 22.	Restart timing without Diagnostic Enable (Permanent)	15
Figure 23.	Restart timing with Diagnostic Enable (Permanent)	15
Figure 24.	Current detection: Load impedance magnitude $ Z_L $ Vs. output peak voltage of the sinus.	16
Figure 25.	Data Validity on the I ² C BUS	19
Figure 26.	Timing diagram on the I ² C Bus.	20
Figure 27.	Timing acknowledge clock pulse	20
Figure 28.	Flexiwatt25 Mechanical Data & Package Dimensions	26

1 Block diagram and application & test circuit

1.1 Block diagram

Figure 1. Block diagram

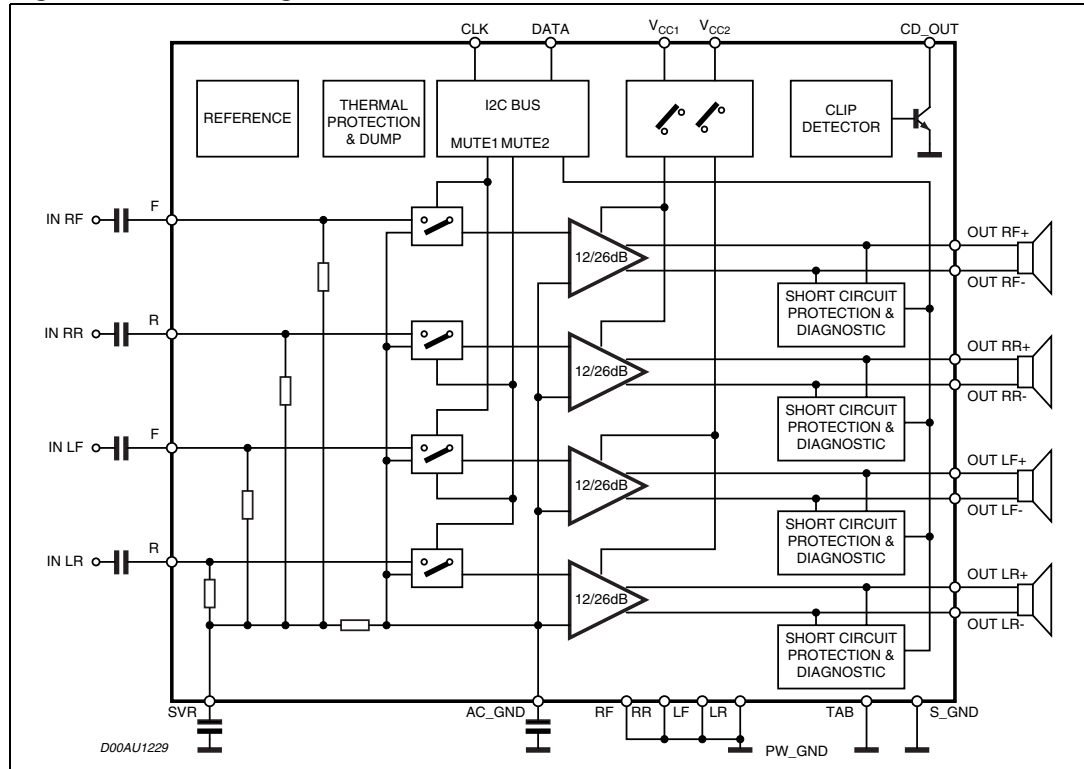

1.2 Application and test circuit

Figure 2. Application and test circuit

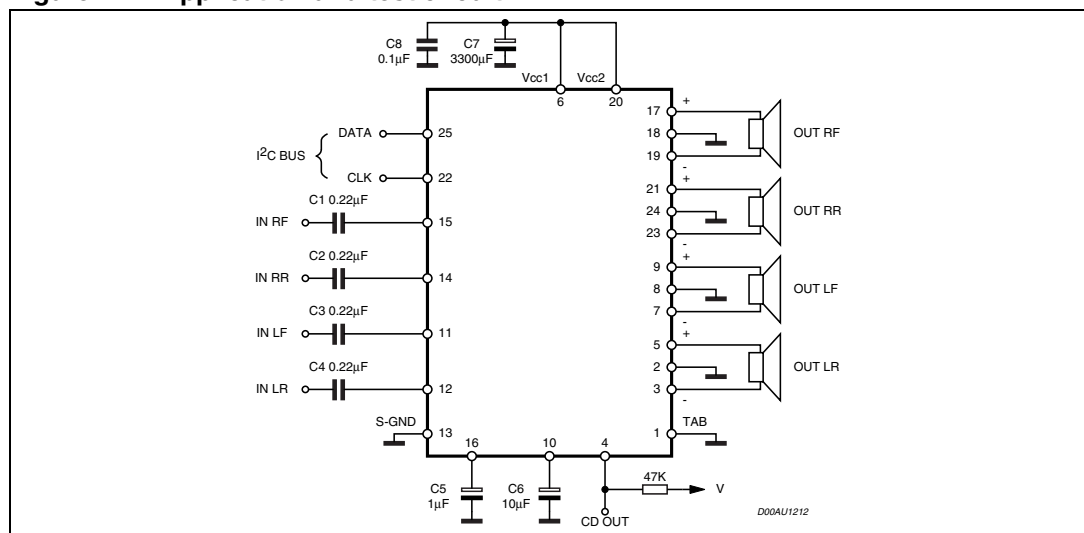

2 Pin description

Figure 3. Pin connection (top view)

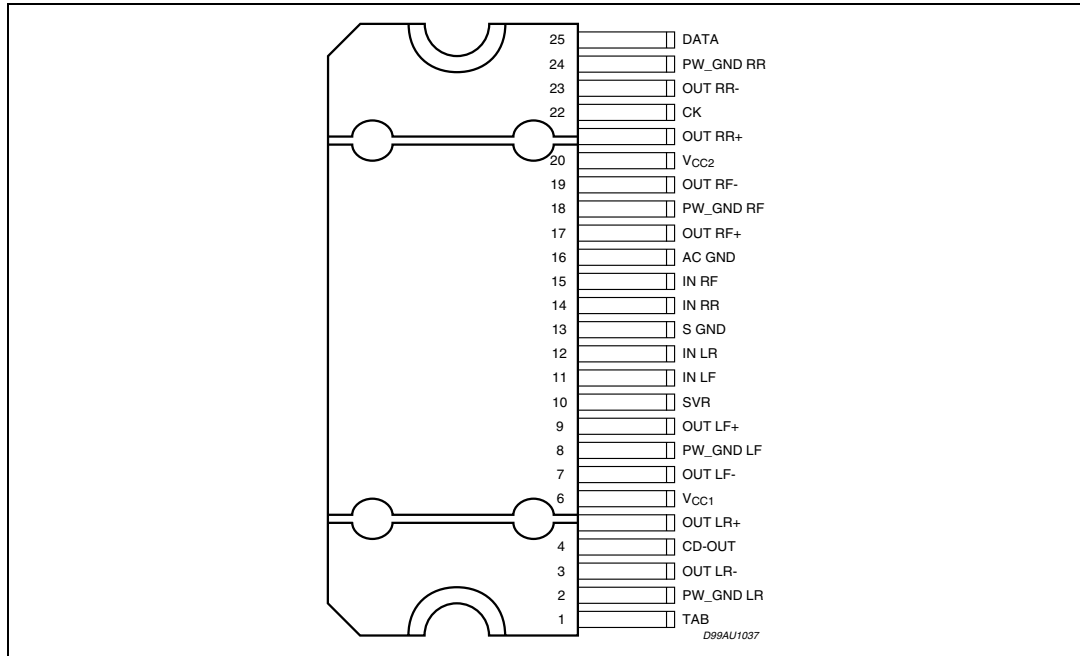

3 Electrical specifications

3.1 Absolute maximum ratings

Table 1. Absolute maximum ratings

Symbol	Parameter	Value	Unit
V_{op}	Operating Supply Voltage	18	V
V_S	DC Supply Voltage	28	V
V_{peak}	Peak Supply Voltage (for $t = 50ms$)	50	V
V_{CK}	CK pin Voltage	6	V
V_{DATA}	Data Pin Voltage	6	V
I_O	Output Peak Current (not repetitive $t = 100\mu s$)	8	A
I_O	Output Peak Current (repetitive $f > 10Hz$)	6	A
P_{tot}	Power Dissipation $T_{case} = 70^\circ C$	85	W
T_{stg}, T_j	Storage and Junction Temperature	-55 to 150	$^\circ C$

3.2 Thermal data

Table 2. Thermal data

Symbol	Description	Value	Unit
$R_{th\ j-case}$	Thermal Resistance Junction-case	Max. 1	$^\circ C/W$

3.3 Electrical characteristics

www.DataSheet4U.com

Table 3. Electrical characteristics

(Refer to the test circuit, $V_S = 14.4V$; $R_L = 4\Omega$; $f = 1KHz$; $G_V = 26dB$; $T_{amb} = 25^\circ C$; unless otherwise specified.)

Symbol	Parameter	Test Condition	Min.	Typ.	Max.	Unit
POWER AMPLIFIER						
V_S	Supply Voltage Range		8		18	V
I_d	Total Quiescent Drain Current			150	300	mA
P_O	Output Power	Max. ($V_S = 14.4V$)	35	40		W
		THD = 10%	22	25		W
		THD = 1%	16	20		W
		$R_L = 2\Omega$; EIAJ ($V_S = 13.7V$)	50	55		W
		$R_L = 2\Omega$; THD 10%	32	38		W
		$R_L = 2\Omega$; THD 1%	25	30		W
		$R_L = 2\Omega$; MAX POWER	55	60		W

Electrical specifications

TDA7566

Table 3. Electrical characteristics (continued)

(Refer to the test circuit, $V_S = 14.4V$; $R_L = 4\Omega$; $f = 1KHz$; $G_V = 26dB$; $T_{amb} = 25^\circ C$; unless otherwise specified.)

Symbol	Parameter	Test Condition	Min.	Typ.	Max.	Unit
THD	Total Harmonic Distortion	$P_O = 1W$ to $10W$;		0.04	0.1	%
		$G_V = 12dB$; $V_O = 0.1$ to $5V_{RMS}$		0.02	0.05	%
C_T	Cross Talk	$f = 1KHz$ to $10KHz$, $R_G = 600W$	50	60		dB
R_{IN}	Input Impedance		60	100	130	$K\Omega$
G_{V1}	Voltage Gain 1		25	26	27	dB
ΔG_{V1}	Voltage Gain Match 1		-1	0	1	dB
G_{V2}	Voltage Gain 2			12		dB
E_{IN1}	Output Noise Voltage 1	$R_g = 600\Omega$; 20Hz to 22kHz		35	100	μV
E_{IN2}	Output Noise Voltage 2	$R_g = 600\Omega$; $G_V = 12dB$; 20Hz to 22kHz		12		μV
SVR	Supply Voltage Rejection	$f = 100Hz$ to $10kHz$; $V_r = 1V_{pk}$; $R_g = 600\Omega$	50	60		dB
BW	Power Bandwidth		100			KHz
A_{SB}	Stand-by Attenuation		90	110		dB
I_{SB}	Stand-by Current			25	100	μA
A_M	Mute Attenuation		80	100		dB
V_{OS}	Offset Voltage	Mute & Play	-100	0	100	mV
V_{AM}	Min. Supply Voltage Threshold		7	7.5	8	V
T_{ON}	Turn on Delay	D2/D1 (IB1) 0 to 1		20	50	ms
T_{OFF}	Turn off Delay	D2/D1 (IB1) 1 to 0		20	50	ms
CD_{LK}	Clip Det High Leakage Current	CD off		0	15	μA
CD_{SAT}	Clip Det Sat. Voltage	CD on; $I_{CD} = 1mA$			300	mV
CD_{THD}	Clip Det THD level	D0 (IB1) = 0	0	1	2	%
		D0 (IB1) = 1	5	10	15	%
TURN ON DIAGNOSTICS 1 (Power Amplifier Mode)						
Pgnd	Short to GND det. (below this limit, the Output is considered in Short Circuit to GND)	Power Amplifier in st-by			1.2	V
Pvs	Short to Vs det. (above this limit, the Output is considered in Short Circuit to VS)		Vs -1.2			V
Pnop	Normal operation thresholds. (Within these limits, the Output is considered without faults).		1.8		Vs -1.8	V

Table 3. Electrical characteristics (continued)(Refer to the test circuit, $V_S = 14.4V$; $R_L = 4\Omega$; $f = 1KHz$; $G_V = 26dB$; $T_{amb} = 25^\circ C$; unless otherwise specified.)

Symbol	Parameter	Test Condition	Min.	Typ.	Max.	Unit
Lsc	Shorted Load det.				0.5	W
Lop	Open Load det.		85			W
Lnop	Normal Load det.		1.65		45	W
TURN ON DIAGNOSTICS 2 (Line Driver Mode)						
Pgnd	Short to GND det. (below this limit, the Output is considered in Short Circuit to GND)	Power Amplifier in st-by			1.2	V
Pvs	Short to Vs det. (above this limit, the Output is considered in Short Circuit to VS)		Vs -1.2			V
Pnop	Normal operation thresholds. (Within these limits, the Output is considered without faults).		1.8		Vs -1.8	V
Lsc	Shorted Load det.				2	W
Lop	Open Load det.		330			W
Lnop	Normal Load det.		7		180	W
PERMANENT DIAGNOSTICS 2 (Power Amplifier Mode or Line Driver Mode)						
Pgnd	Short to GND det. (below this limit, the Output is considered in Short Circuit to GND)	Power Amplifier in Mute or Play, one or more short circuits protection activated			1.2	V
Pvs	Short to Vs det. (above this limit, the Output is considered in Short Circuit to VS)		Vs -1.2			V
Pnop	Normal operation thresholds. (Within these limits, the Output is considered without faults).		1.8		Vs -1.8	V
L _{SC}	Shorter Load det.	Power Amplifier mode			0.5	W
		Line Driver mode			2	W
V _O	Offset Detection	Power Amplifier in play, AC Input signals = 0	1.5	2	2.5	V
I _{NL}	Normal load current detection	$V_O < (V_S - 5)pk$	500			mA
I _{OL}	Open load current detection				250	mA
I²C BUS INTERFACE						
f _{SCL}	Clock Frequency			400		KHz
V _{IL}	Input Low Voltage				1.5	V
V _{IH}	Input High Voltage		2.3			V

3.4 Electrical characteristics curves

Figure 4. Quiescent current vs. Supply voltage

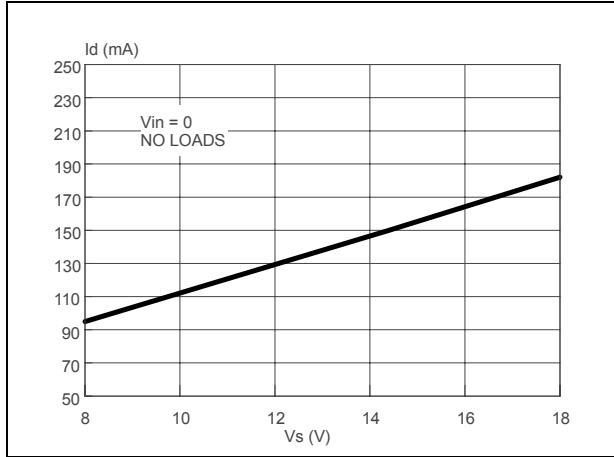

Figure 5. Output power vs. supply voltage (4Ω)

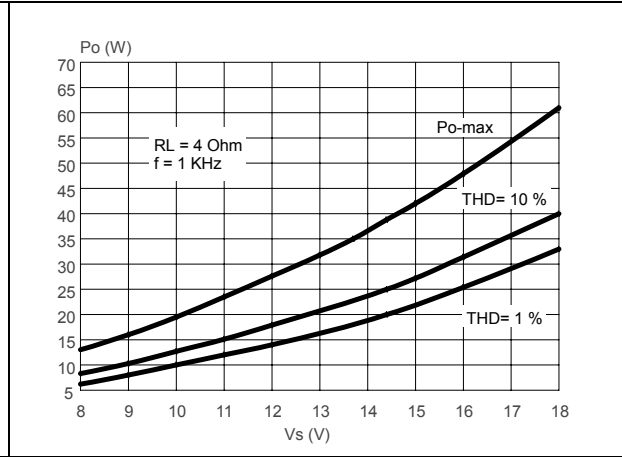

Figure 6. Output power vs. supply voltage (2Ω)

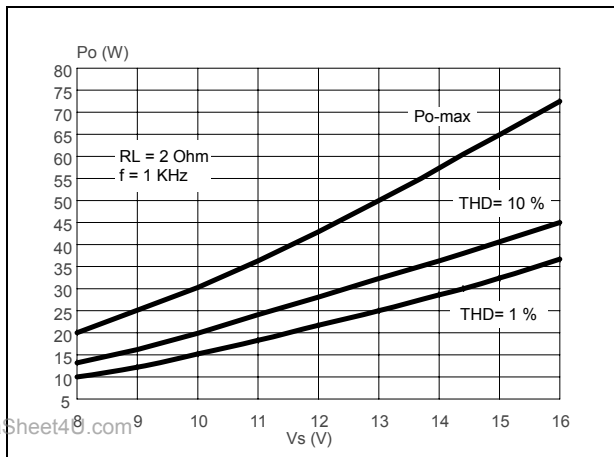

Figure 7. Distortion vs. output power (4Ω)

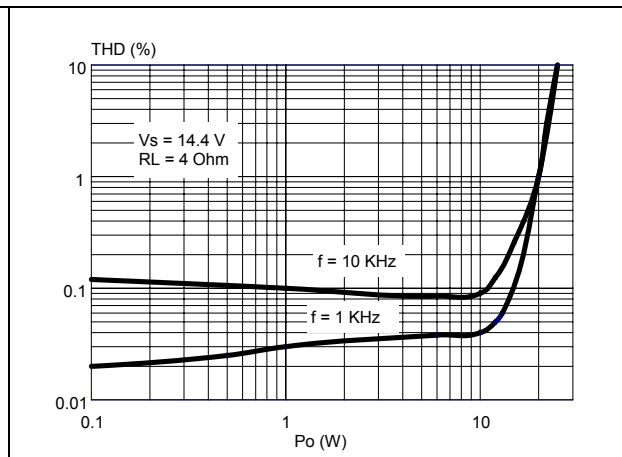

Figure 8. Distortion vs. output power (2Ω)

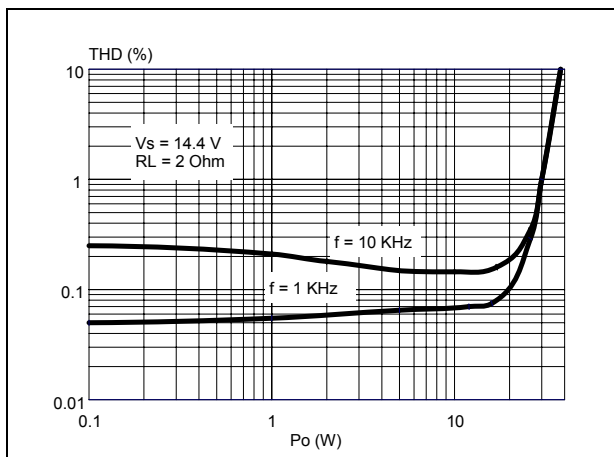

Figure 9. Distortion vs. frequency (4Ω)

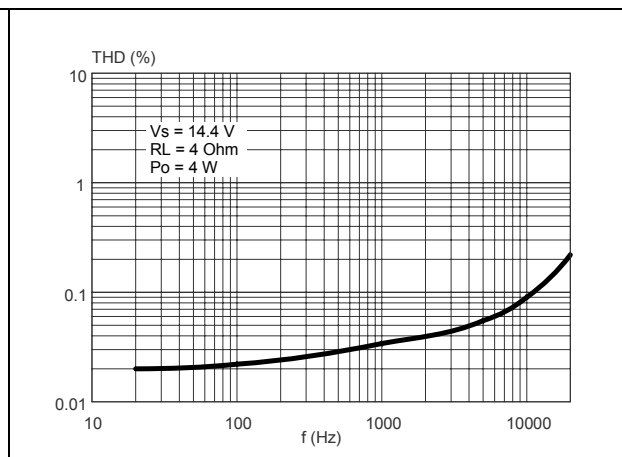

Figure 10. Distortion vs. frequency (2Ω)

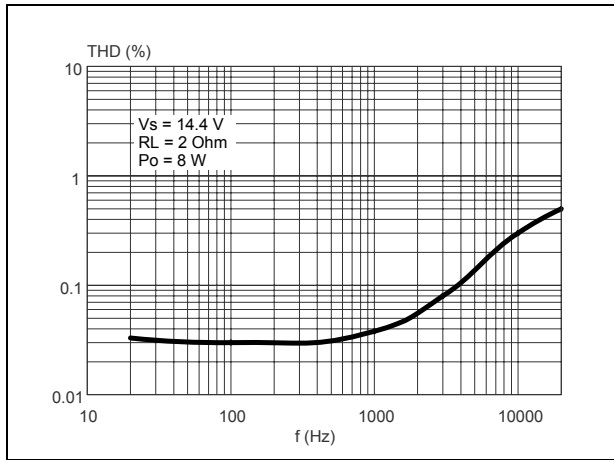

Figure 11. Crosstalk vs. frequency

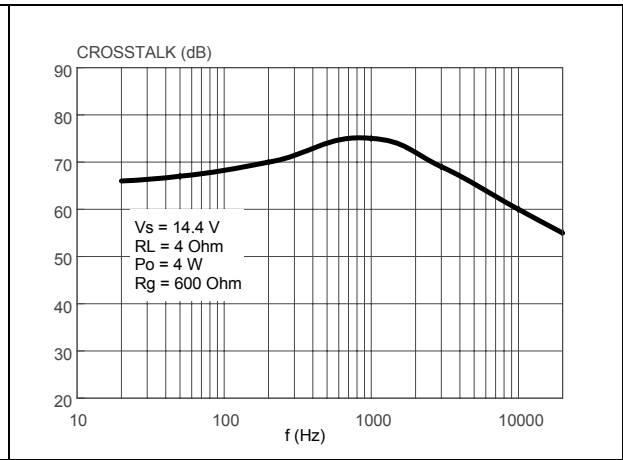

Figure 12. Supply voltage rejection vs. frequency

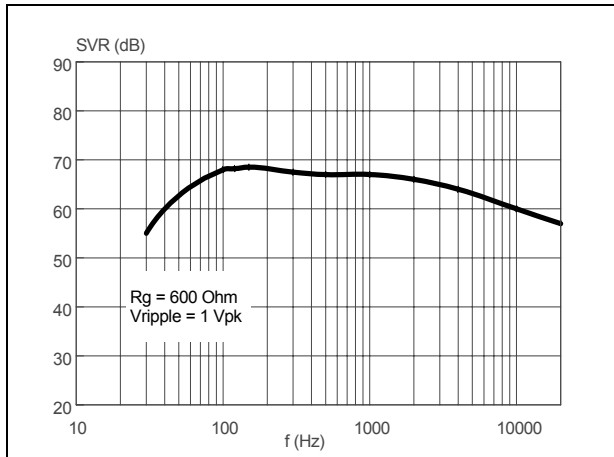

Figure 13. Power Dissipation & Efficiency vs. Output Power (4Ω, SINE)

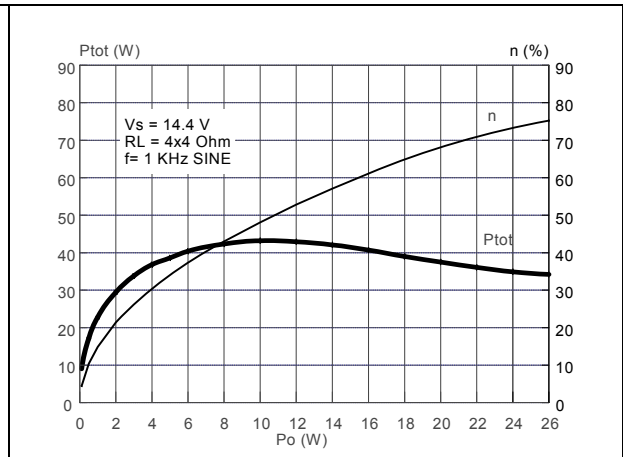

Figure 14. Power Dissipation vs. Average Output Power (Audio Program Simulation, 4Ω)

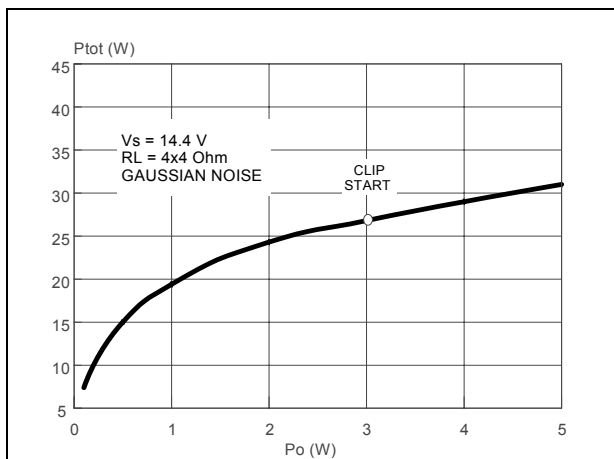
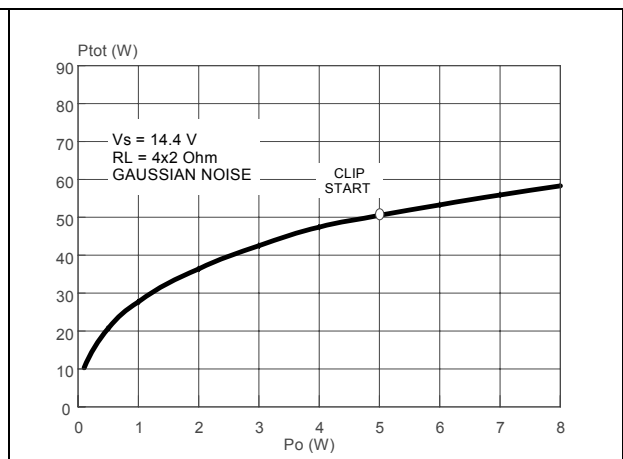

Figure 15. Power Dissipation vs. Average Output Power (Audio Program Simulation, 2Ω)



www.DataSheet4U.com

4 Diagnostics functional description

4.1 Turn-on diagnostic

It is activated at the turn-on (stand-by out) under I²C bus request. Detectable output faults are:

- Short to gnd
- Short to V_S
- Short across the speaker
- Open speaker

To verify if any of the above misconnections are in place, a subsonic (inaudible) current pulse (*Figure 16*) is internally generated, sent through the speaker(s) and sunk back. The Turn On diagnostic status is internally stored until a successive diagnostic pulse is requested (after a I²C reading).

If the "stand-by out" and "diag. enable" commands are both given through a single programming step, the pulse takes place first (power stage still in stand-by mode, low, outputs = high impedance).

Afterwards, when the Amplifier is biased, the PERMANENT diagnostic takes place. The previous Turn On state is kept until a short appears at the outputs.

Figure 16. Turn - On diagnostic: working principle

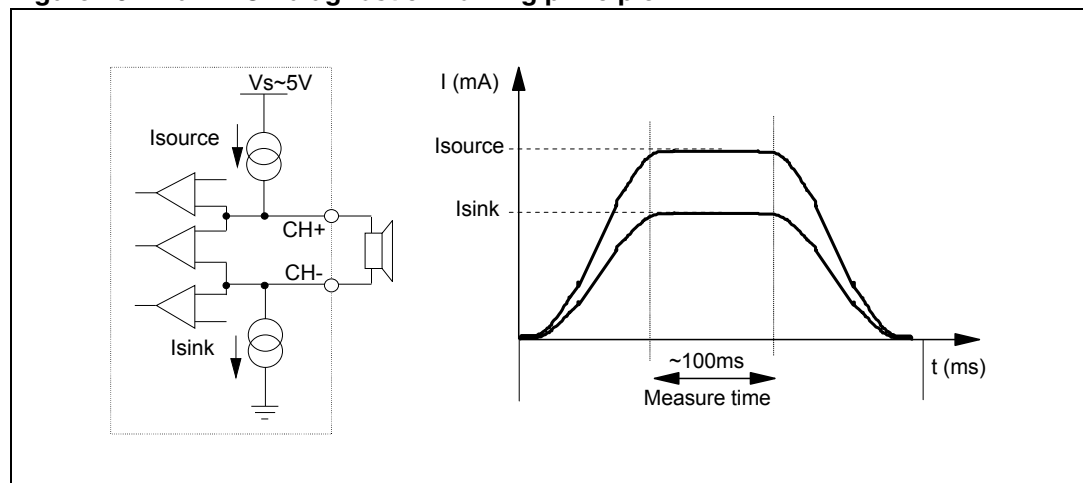

Figure 17 and *18* show SVR and OUTPUT waveforms at the turn-on (stand-by out) with and without TURN-ON DIAGNOSTIC.

Figure 17. SVR and Output behaviour (CASE 1: without turn-on diagnostic)

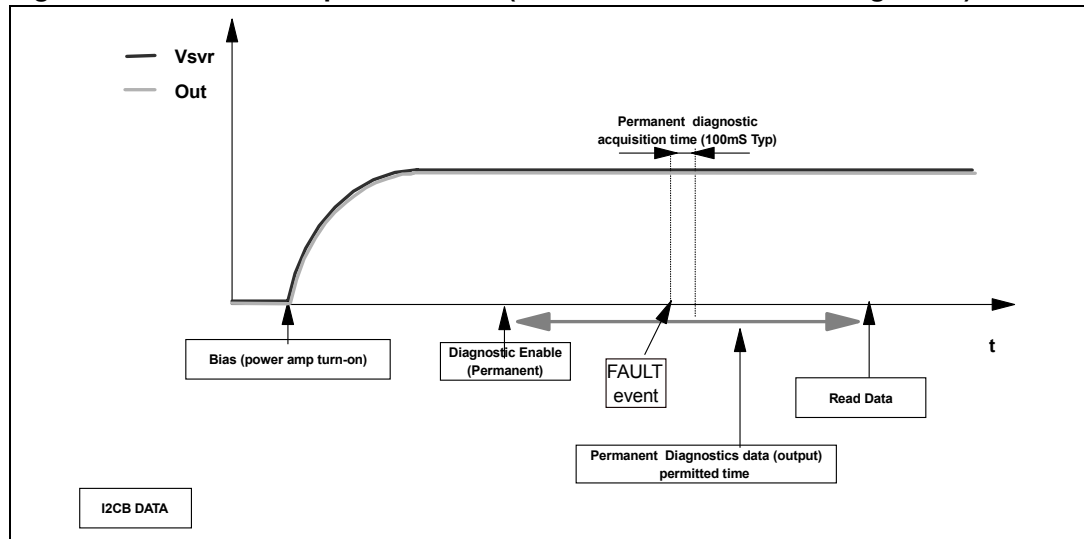
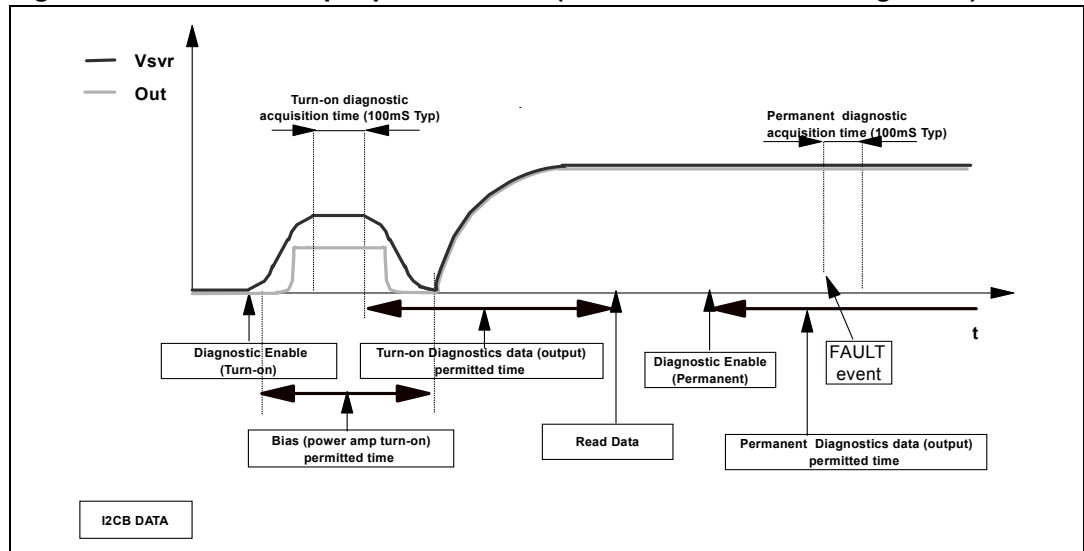

Figure 18. SVR and Output pin behaviour (CASE 2: with turn-on diagnostic)



www.DataSheet4U.com

The information related to the outputs status is read and memorized at the end of the current pulse top. The acquisition time is 100 ms (typ.). No audible noise is generated in the process. As for SHORT TO GND / Vs the fault-detection thresholds remain unchanged from 26 dB to 12 dB gain setting. They are as follows:

Figure 19. Thresholds for SHORT TO GND/Vs

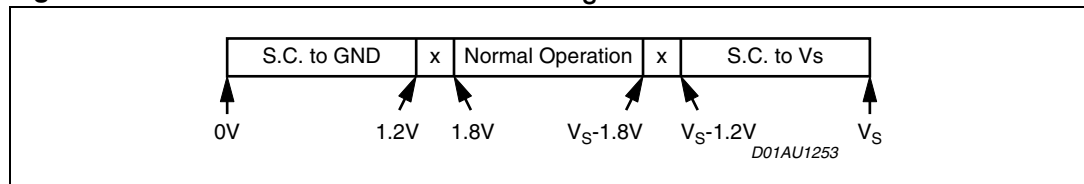

Concerning SHORT ACROSS THE SPEAKER / OPEN SPEAKER, the threshold varies from 26 dB to 12 dB gain setting, since different loads are expected (either normal speaker's impedance or high impedance). The values in case of 26 dB gain are as follows:

Figure 20. Thresholds for SHORT ACROSS THE SPEAKER/OPEN SPEAKER

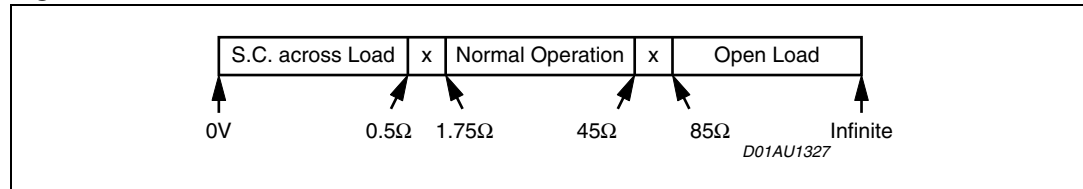

If the Line-Driver mode ($G_v = 12$ dB and Line Driver Mode diagnostic = 1) is selected, the same thresholds will change as follows:

Figure 21. Thresholds for Line-Drivers

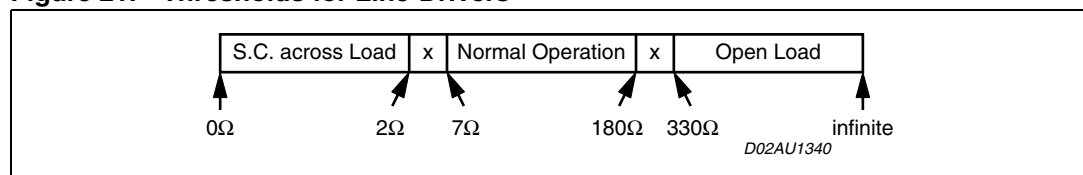

4.2 Permanent diagnostics

Detectable conventional faults are:

- SHORT TO GND
- SHORT TO V_s
- SHORT ACROSS THE SPEAKER

The following additional features are provided:

- OUTPUT OFFSET DETECTION
- AC DIAGNOSTIC

www.DataSheet4U.com

The TDA7566 has 2 operating statuses:

1. **RESTART mode.** The diagnostic is not enabled. Each audio channel operates independently from each other. If any of the a.m. faults occurs, only the channel(s) interested is shut down. A check of the output status is made every 1 ms (*Figure 22*). Restart takes place when the overload is removed.
2. **DIAGNOSTIC mode.** It is enabled via I²C bus and self activates if an output overload (such to cause the intervention of the short-circuit protection) occurs to the speakers outputs . Once activated, the diagnostics procedure develops as follows (*Figure 23*):
 - To avoid momentary re-circulation spikes from giving erroneous diagnostics, a check of the output status is made after 1ms: if normal situation (no overloads) is detected, the diagnostic is not performed and the channel returns back active.
 - Instead, if an overload is detected during the check after 1 ms, then a diagnostic cycle having a duration of about 100 ms is started.
 - After a diagnostic cycle, the audio channel interested by the fault is switched to RESTART mode. The relevant data are stored inside the device and can be read by the microprocessor. When one cycle has terminated, the next one is activated

by an I²C reading. This is to ensure continuous diagnostics throughout the car-radio operating time.

- To check the status of the device a sampling system is needed. The timing is chosen at microprocessor level (over half a second is recommended).

Figure 22. Restart timing without Diagnostic Enable (Permanent)
Each 1ms time, a sampling of the fault is done

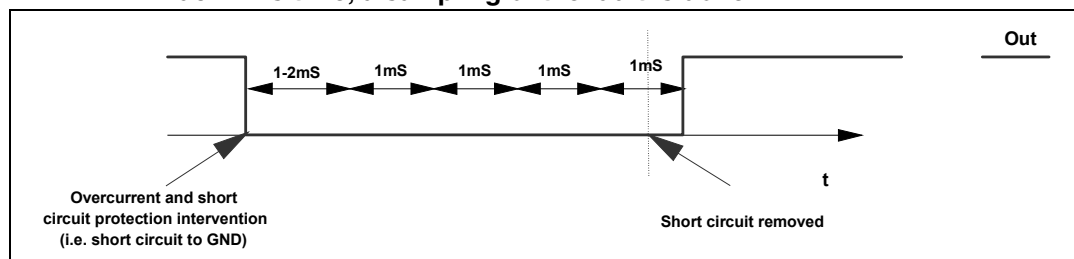
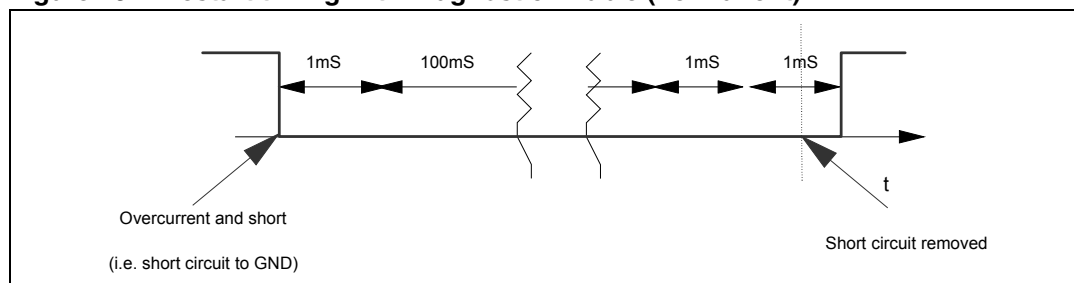

Figure 23. Restart timing with Diagnostic Enable (Permanent)



4.3 Output DC offset detection

Any DC output offset exceeding $\pm 2V$ are signalled out. This inconvenient might occur as a consequence of initially defective or aged and worn-out input capacitors feeding a DC component to the inputs, so putting the speakers at risk of overheating.

This diagnostic has to be performed with low-level output AC signal (or $V_{in} = 0$).

The test is run with selectable time duration by microprocessor (from a "start" to a "stop" command):

START = Last reading operation or setting IB1 - D5 - (OFFSET enable) to 1

STOP = Actual reading operation

Excess offset is signalled out if persistent throughout the assigned testing time. This feature is disabled if any overloads leading to activation of the short-circuit protection occurs in the process.

4.4 AC diagnostic

It is targeted at detecting accidental disconnection of tweeters in 2-way speaker and, more in general, presence of capacitively (AC) coupled loads.

This diagnostic is based on the notion that the overall speaker's impedance (woofer + parallel tweeter) will tend to increase towards high frequencies if the tweeter gets

disconnected, because the remaining speaker (woofer) would be out of its operating range (high impedance). The diagnostic decision is made according to peak output current thresholds, as follows:

$$I_{out} > 500\text{mA}_{pk} = \text{NORMAL STATUS}$$

$$I_{out} < 250\text{mA}_{pk} = \text{OPEN TWEETER}$$

To correctly implement this feature, it is necessary to briefly provide a signal tone (with the amplifier in "play") whose frequency and magnitude are such to determine an output current higher than 500mA_{pk} in normal conditions and lower than 250mA_{pk} should the parallel tweeter be missing. The test has to last for a minimum number of 3 sine cycles starting from the activation of the AC diagnostic function IB2<D2> up to the I²C reading of the results (measuring period). To confirm presence of tweeter, it is necessary to find at least 3 current pulses over 500mA over all the measuring period, else an "open tweeter" message will be issued.

The frequency / magnitude setting of the test tone depends on the impedance characteristics of each specific speaker being used, with or without the tweeter connected (to be calculated case by case). High-frequency tones (> 10 KHz) or even ultrasonic signals are recommended for their negligible acoustic impact and also to maximize the impedance module's ratio between with tweeter-on and tweeter-off.

Figure 24 shows the Load Impedance as a function of the peak output voltage and the relevant diagnostic fields.

This feature is disabled if any overloads leading to activation of the short-circuit protection occurs in the process.

Figure 24. Current detection: Load impedance magnitude |Z| Vs. output peak voltage of the sinus

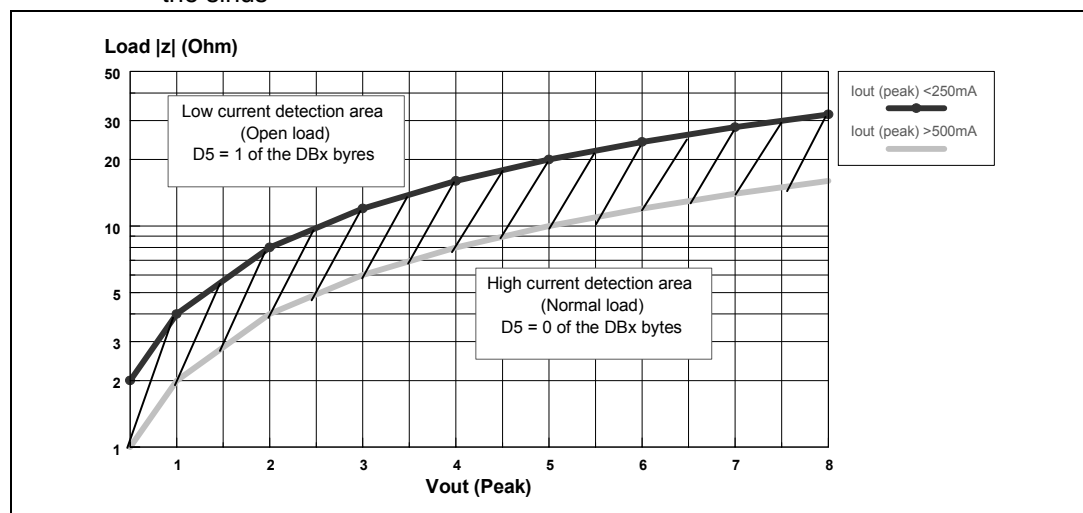

www.DataSheet4U.com

4.5 Multiple faults

When more misconnections are simultaneously in place at the audio outputs, it is guaranteed that at least one of them is initially read out. The others are notified after successive cycles of I²C reading and faults removal, provided that the diagnostic is enabled. This is true for both kinds of diagnostic (Turn on and Permanent).

The table below shows all the couples of double-fault possible. It should be taken into account that a short circuit with the 4 ohm speaker unconnected is considered as double fault.

Table 4. Double Fault Table for Turn On Diagnostic

	S. GND (so)	S. GND (sk)	S. Vs	S. Across L.	Open L.
S. GND (so)	S. GND	S. GND	S. Vs + S. GND	S. GND	S. GND
S. GND (sk)	/	S. GND	S. Vs	S. GND	Open L. (*)
S. Vs	/	/	S. Vs	S. Vs	S. Vs
S. Across L.	/	/	/	S. Across L.	N.A.
Open L.	/	/	/	/	Open L. (*)

S. GND (so) / S. GND (sk) in the above table make a distinction according to which of the 2 outputs is shorted to ground (test-current source side= so, test-current sink side = sk). More precisely, in channels LF and LR, so = CH+, sk = CH-; in channels LR and RF, so = CH-, SK = CH+.

In Permanent Diagnostic the table is the same, with only a difference concerning Open Load (*), which is not among the recognisable faults. Should an Open Load be present during the device's normal working, it would be detected at a subsequent Turn on Diagnostic cycle (i.e. at the successive Car Radio Turn on).

4.6 Faults availability

All the results coming from I²Cbus, by read operations, are the consequence of measurements inside a defined period of time. If the fault is stable throughout the whole period, it will be sent out. This is true for DC diagnostic (Turn on and Permanent), for Offset Detector, for AC Diagnostic (the low current sensor needs to be stable to confirm the Open tweeter).

www.DataSheet4U.com

To guarantee always resident functions, every kind of diagnostic cycles (Turn on, Permanent, Offset, AC) will be reactivate after any I²C reading operation. So, when the micro reads the I²C, a new cycle will be able to start, but the read data will come from the previous diag. cycle (i.e. The device is in Turn On state, with a short to Gnd, then the short is removed and micro reads I²C. The short to Gnd is still present in bytes, because it is the result of the previous cycle. If another I²C reading operation occurs, the bytes do not show the short). In general to observe a change in Diagnostic bytes, two I²C reading operations are necessary.

4.7 I²C Programming/reading sequence

A correct turn on/off sequence respectful of the diagnostic timings and producing no audible noises could be as follows (after battery connection):

TURN-ON: (STAND-BY OUT + DIAG ENABLE) --- 500 ms (min) --- MUTING OUT

TURN-OFF: MUTING IN --- 20 ms --- (DIAG DISABLE + STAND-BY IN)

Diagnostics functional description**TDA7566**

Car Radio Installation: DIAG ENABLE (write) --- 200 ms --- I²C read (repeat until All faults disappear).

AC TEST: FEED H.F. TONE -- AC DIAG ENABLE (write) --- WAIT > 3 CYCLES --- I²C read (repeat I²C reading until tweeter-off message disappears).

OFFSET TEST: Device in Play (no signal) -- OFFSET ENABLE - 30ms - I²C reading (repeat I²C reading until high-offset message disappears).

5 I²C Bus interface

Data transmission from microprocessor to the TDA7566 and viceversa takes place through the 2 wires I²C BUS interface, consisting of the two lines SDA and SCL (pull-up resistors to positive supply voltage must be connected).

5.1 Data Validity

As shown by [Figure 25](#), the data on the SDA line must be stable during the high period of the clock.

The HIGH and LOW state of the data line can only change when the clock signal on the SCL line is LOW.

5.2 Start and Stop Conditions

As shown by [Figure 26](#) a start condition is a HIGH to LOW transition of the SDA line while SCL is HIGH.

The stop condition is a LOW to HIGH transition of the SDA line while SCL is HIGH.

5.3 Byte Format

Every byte transferred to the SDA line must contain 8 bits. Each byte must be followed by an acknowledge bit. The MSB is transferred first.

5.4 Acknowledge

The transmitter* puts a resistive HIGH level on the SDA line during the acknowledge clock pulse (see [Figure 27](#)). The receiver** the acknowledges has to pull-down (LOW) the SDA line during the acknowledge clock pulse, so that the SDA line is stable LOW during this clock pulse.

www.DataSheet4U.com

* Transmitter

- master (μ P) when it writes an address to the TDA7566
- slave (TDA7566) when the μ P reads a data byte from TDA7566

** Receiver

- slave (TDA7566) when the μ P writes an address to the TDA7566
- master (μ P) when it reads a data byte from TDA7566

Figure 25. Data Validity on the I²C BUS

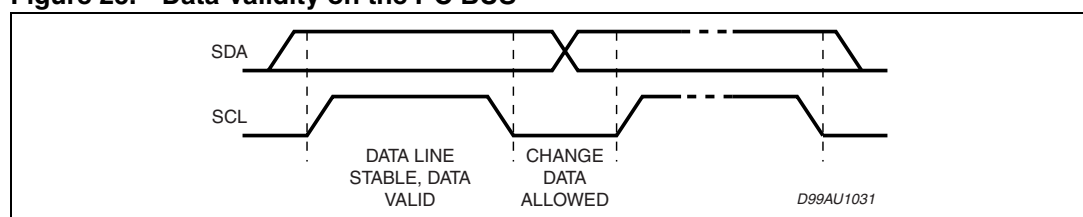

6 Software specifications

All the functions of the TDA7566 are activated by I²C interface.

The bit 0 of the "ADDRESS BYTE" defines if the next bytes are write instruction (from μ P to TDA7566) or read instruction (from TDA7566 to μ P).

Table 5. Chip Address:

D7							D0	D8 Hex
1	1	0	1	1	0	0	X	

X = 0 Write to device

X = 1 Read from device

If R/W = 0, the μ P sends 2 "Instruction Bytes": IB1 and IB2.

Table 6. IB1

D7	0
D6	Diagnostic enable (D6 = 1) Diagnostic defeat (D6 = 0)
D5	Offset Detection enable (D5 = 1) Offset Detection defeat (D5 = 0)
D4	Front Channel Gain = 26dB (D4 = 0) Gain = 12dB (D4 = 1)
D3	Rear Channel Gain = 26dB (D3 = 0) Gain = 12dB (D3 = 1)
D2	Mute front channels (D2 = 0) Unmute front channels (D2 = 1)
D1	Mute rear channels (D1 = 0) Unmute rear channels (D1 = 1)
D0	CD 2% (D0 = 0) CD 10% (D0 = 1)

Table 7. IB2

D7	0
D6	0
D5	0
D4	Stand-by on - Amplifier not working - (D4 = 0) Stand-by off - Amplifier working - (D4 = 1)
D3	Power amplifier mode diagnostic (D3 = 0) Line driver mode diagnostic (D3 = 1)

Table 7. IB2 (continued)

D2	Current detection diagnostic enabled (D2 = 1) Current detection diagnostic defeat (D2 = 0)
D1	0
D0	0

If R/W = 1, the TDA7566 sends 4 "Diagnostics Bytes" to mP: DB1, DB2, DB3 and DB4.

Table 8. DB1

D7	Thermal warning active (D7 = 1)
D6	Diag. cycle not activated or not terminated (D6 = 0) Diag. cycle terminated (D6 = 1)
D5	Channel LF current detection Output peak current < 250mA - Open load (D5 = 1) Output peak current > 500mA - Open load (D5 = 0)
D4	Channel LF Turn-on diagnostic (D4 = 0) Permanent diagnostic (D4 = 1)
D3	Channel LF Normal load (D3 = 0) Short load (D3 = 1)
D2	Channel LF Turn-on diag.: No open load (D2 = 0) Open load detection (D2 = 1) Offset diag.: No output offset (D2 = 0) Output offset detection (D2 = 1)
D1	Channel LF No short to Vcc (D1 = 0) Short to Vcc (D1 = 1)
D0	Channel LF No short to GND (D1 = 0) Short to GND (D1 = 1)

www.DataSheet4U.com

Table 9. DB2

D7	Offset detection not activated (D7 = 0) Offset detection activated (D7 = 1)
D6	Current sensor not activated (D6 = 0) Current sensor activated (D6 = 1)
D5	Channel LR current detection Output peak current < 250mA - Open load (D5 = 1) Output peak current > 500mA - Open load (D5 = 0)

Table 9. DB2 (continued)

D4	Channel LR Turn-on diagnostic (D4 = 0) Permanent diagnostic (D4 = 1)
D3	Channel LR Normal load (D3 = 0) Short load (D3 = 1)
D2	Channel LR Turn-on diag.: No open load (D2 = 0) Open load detection (D2 = 1) Permanent diag.: No output offset (D2 = 0) Output offset detection (D2 = 1)
D1	Channel LR No short to Vcc (D1 = 0) Short to Vcc (D1 = 1)
D0	Channel LR No short to GND (D1 = 0) Short to GND (D1 = 1)

Table 10. DB3

D7	Stand-by status (= IB1 - D4)
D6	Diagnostic status (= IB1 - D6)
D5	Channel RF current detection Output peak current < 250mA - Open load (D5 = 1) Output peak current > 500mA - Open load (D5 = 0)
D4	Channel RF Turn-on diagnostic (D4 = 0) Permanent diagnostic (D4 = 1)
D3	Channel RF Normal load (D3 = 0) Short load (D3 = 1)
D2	Channel RF Turn-on diag.: No open load (D2 = 0) Open load detection (D2 = 1) Permanent diag.: No output offset (D2 = 0) Output offset detection (D2 = 1)
D1	Channel RF No short to Vcc (D1 = 0) Short to Vcc (D1 = 1)
D0	Channel RF No short to GND (D1 = 0) Short to GND (D1 = 1)

Table 11. DB4

D7	X
D6	X
D5	Channel R Rcurrent detection Output peak current < 250mA - Open load (D5 = 1) Output peak current > 500mA - Open load (D5 = 0)
D4	Channel RR Turn-on diagnostic (D4 = 0) Permanent diagnostic (D4 = 1)
D3	Channel RR Normal load (D3 = 0) Short load (D3 = 1)
D2	Channel RR Turn-on diag.: No open load (D2 = 0) Open load detection (D2 = 1) Permanent diag.: No output offset (D2 = 0) Output offset detection (D2 = 1)
D1	Channel RR No short to Vcc (D1 = 0) Short to Vcc (D1 = 1)
D0	Channel RR No short to GND (D1 = 0) Short to GND (D1 = 1)

7 Examples of bytes sequence

1 - Turn-On diagnostic - Write operation

Start	Address byte with D0 = 0	ACK	IB1 with D6 = 1	ACK	IB2	ACK	STOP
-------	--------------------------	-----	-----------------	-----	-----	-----	------

2 - Turn-On diagnostic - Read operation

Start	Address byte with D0 = 1	ACK	DB1	ACK	DB2	ACK	DB3	ACK	DB4	ACK	STOP
-------	--------------------------	-----	-----	-----	-----	-----	-----	-----	-----	-----	------

The delay from 1 to 2 can be selected by software, starting from 1ms

3a - Turn-On of the power amplifier with 26dB gain, mute on, diagnostic defeat.

Start	Address byte with D0 = 0	ACK	IB1	ACK	IB2	ACK	STOP
			X000000X		XXX1X0XX		

3b - Turn-Off of the power amplifier

Start	Address byte with D0 = 0	ACK	IB1	ACK	IB2	ACK	STOP
			X0XXXXXX		XXX0XXXX		

4 - Offset detection procedure enable

Start	Address byte with D0 = 0	ACK	IB1	ACK	IB2	ACK	STOP
			XX1XX11X		XXX1X0XX		

5 - Offset detection procedure stop and reading operation (the results are valid only for the offset detection bits (D2 of the bytes DB1, DB2, DB3, DB4).

Start	Address byte with D0 = 1	ACK	DB1	ACK	DB2	ACK	DB3	ACK	DB4	ACK	STOP
-------	--------------------------	-----	-----	-----	-----	-----	-----	-----	-----	-----	------

- The purpose of this test is to check if a D.C. offset (2V typ.) is present on the outputs, produced by input capacitor with anomalous leakage current or humidity between pins.

www.DataSheet4U.com ● The delay from 4 to 5 can be selected by software, starting from 1ms

6 - Current detection procedure start (the AC inputs must be with a proper signal that depends on the type of load)

Start	Address byte with D0 = 0	ACK	IB1	ACK	IB2	ACK	STOP
			XX01111X		XXX1X1XX		

7 - Current detection reading operation (the results valid only for the current sensor detection bits - D5 of the bytes DB1, DB2, DB3, DB4).

Start	Address byte with D0 = 1	ACK	DB1	ACK	DB2	ACK	DB3	ACK	DB4	ACK	STOP
-------	--------------------------	-----	-----	-----	-----	-----	-----	-----	-----	-----	------

- During the test, a sinus wave with a proper amplitude and frequency (depending on the loudspeaker under test) must be present. The minimum number of periods that are needed to detect a normal load is 5.
- The delay from 6 to 7 can be selected by software, starting from 1ms.

8 Package informations

In order to meet environmental requirements, ST offers this device in ECOPACK® packages. This package have a Lead-free second level interconnect. The category of second level interconnect is marked on the package and on the inner box label, in compliance with JEDEC Standard JESD97. The maximum ratings related to soldering conditions are also marked on the inner box label. ECOPACK is an ST trademark.

ECOPACK specifications are available at: www.st.com.

Figure 28. Flexiwatt25 Mechanical Data & Package Dimensions

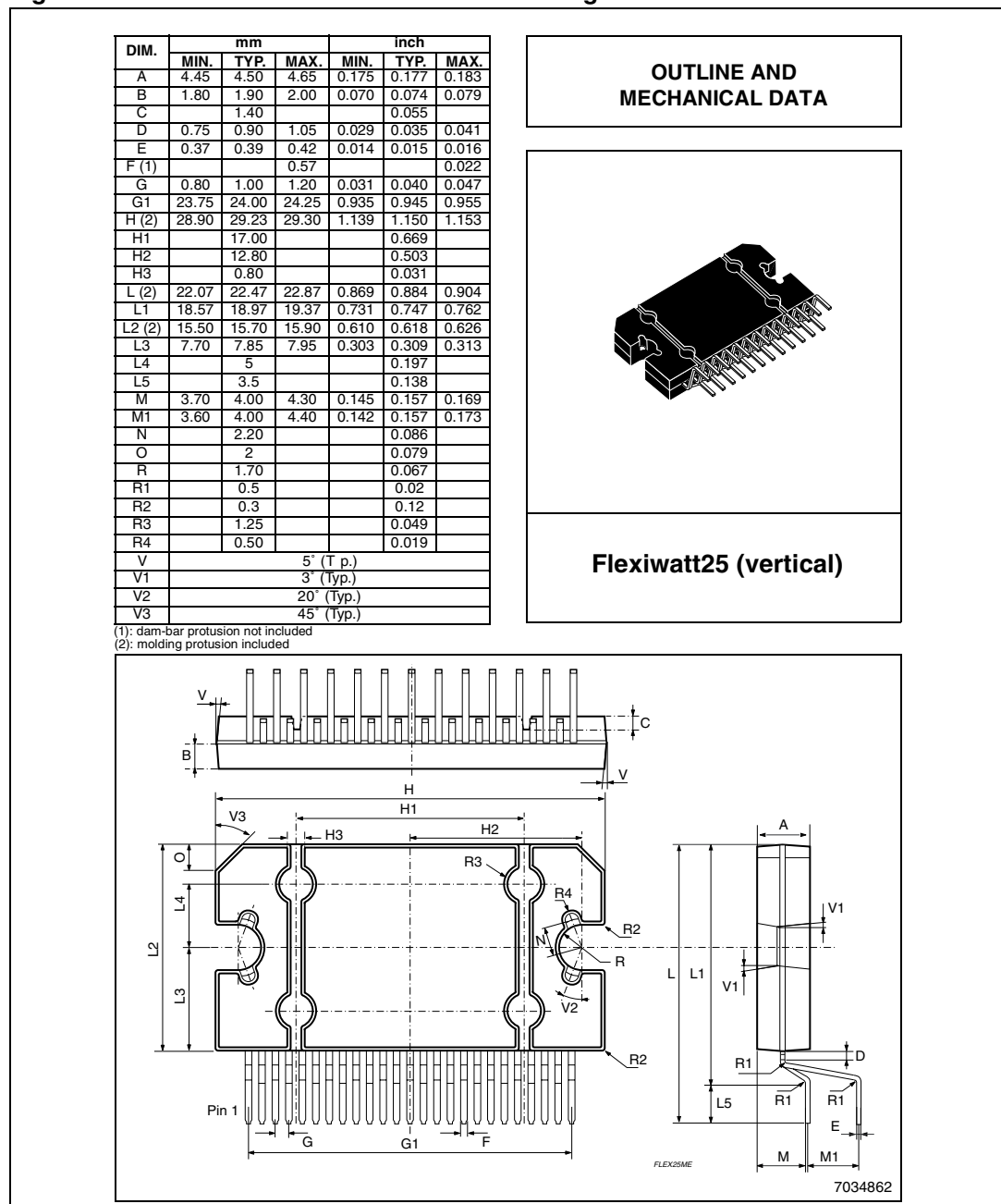

9 Revision history

Table 12. Document revision history

Date	Revision	Changes
20-Sep-2003	1	Initial release.
12-Jul-2006	2	Changed the layout graphic in the new corporate one. Corrected the values of I_{NL} and I_{OL} parameters in the Table 3 on page 9/28.
18-Dec-2006	3	Updated Figure 20 and 21 .

Please Read Carefully:

Information in this document is provided solely in connection with ST products. STMicroelectronics NV and its subsidiaries ("ST") reserve the right to make changes, corrections, modifications or improvements, to this document, and the products and services described herein at any time, without notice.

All ST products are sold pursuant to ST's terms and conditions of sale.

Purchasers are solely responsible for the choice, selection and use of the ST products and services described herein, and ST assumes no liability whatsoever relating to the choice, selection or use of the ST products and services described herein.

No license, express or implied, by estoppel or otherwise, to any intellectual property rights is granted under this document. If any part of this document refers to any third party products or services it shall not be deemed a license grant by ST for the use of such third party products or services, or any intellectual property contained therein or considered as a warranty covering the use in any manner whatsoever of such third party products or services or any intellectual property contained therein.

UNLESS OTHERWISE SET FORTH IN ST'S TERMS AND CONDITIONS OF SALE ST DISCLAIMS ANY EXPRESS OR IMPLIED WARRANTY WITH RESPECT TO THE USE AND/OR SALE OF ST PRODUCTS INCLUDING WITHOUT LIMITATION IMPLIED WARRANTIES OF MERCHANTABILITY, FITNESS FOR A PARTICULAR PURPOSE (AND THEIR EQUIVALENTS UNDER THE LAWS OF ANY JURISDICTION), OR INFRINGEMENT OF ANY PATENT, COPYRIGHT OR OTHER INTELLECTUAL PROPERTY RIGHT.

UNLESS EXPRESSLY APPROVED IN WRITING BY AN AUTHORIZED ST REPRESENTATIVE, ST PRODUCTS ARE NOT RECOMMENDED, AUTHORIZED OR WARRANTED FOR USE IN MILITARY, AIR CRAFT, SPACE, LIFE SAVING, OR LIFE SUSTAINING APPLICATIONS, NOR IN PRODUCTS OR SYSTEMS WHERE FAILURE OR MALFUNCTION MAY RESULT IN PERSONAL INJURY, DEATH, OR SEVERE PROPERTY OR ENVIRONMENTAL DAMAGE. ST PRODUCTS WHICH ARE NOT SPECIFIED AS "AUTOMOTIVE GRADE" MAY ONLY BE USED IN AUTOMOTIVE APPLICATIONS AT USER'S OWN RISK.

www.DataSheet4U.com

Resale of ST products with provisions different from the statements and/or technical features set forth in this document shall immediately void any warranty granted by ST for the ST product or service described herein and shall not create or extend in any manner whatsoever, any liability of ST.

ST and the ST logo are trademarks or registered trademarks of ST in various countries.

Information in this document supersedes and replaces all information previously supplied.

The ST logo is a registered trademark of STMicroelectronics. All other names are the property of their respective owners.

© 2006 STMicroelectronics - All rights reserved

STMicroelectronics group of companies

Australia - Belgium - Brazil - Canada - China - Czech Republic - Finland - France - Germany - Hong Kong - India - Israel - Italy - Japan - Malaysia - Malta - Morocco - Singapore - Spain - Sweden - Switzerland - United Kingdom - United States of America

www.st.com