

FEATURES

- Ultra Low Dropout Voltage
- Compatible with low ESR MLCC as Input/Output Capacitor
- Good Line and Load Regulation
- Guaranteed Output Current of 300mA
- Available in SOT23-5L, DFN2X2-6L and SC70-5L
- Fixed Output Voltages : 1.0V, 1.2V, 1.8V, 2.5V, and 3.3V
- SENSE Option Improves Load Regulation
- Over-Temperature/Over-Current Protection
- -40 °C to 125 °C Junction Temperature Range

APPLICATION

- LCD TVs and SETTOP Boxes
- Battery Powered Equipments
- Motherboards and Graphic Cards
- Microprocessor Power Supplies
- Peripheral Cards
- High Efficiency Linear Regulators
- Battery Chargers

DESCRIPTION

The TJ4203 series of high performance ultra-low dropout linear regulators operates from 2.5V to 6V input supply and provides ultra-low dropout voltage, high output current with low ground current. Wide range of preset output voltage options are available. These ultra-low dropout linear regulators respond fast to step changes in load which makes them suitable for low voltage micro-processor applications. The TJ4203 is developed on a CMOS process technology which allows low quiescent current operation independent of output load current. This CMOS process also allows the TJ4203 to operate under extremely low dropout conditions.

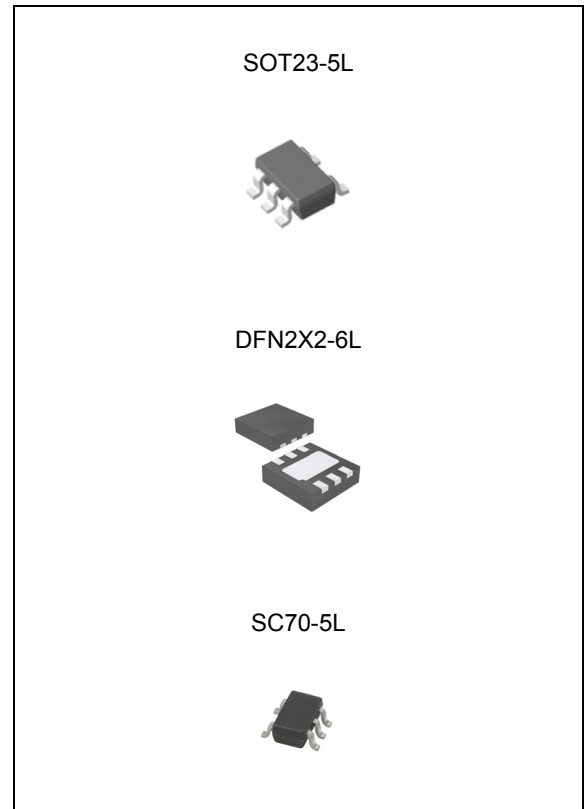

ORDERING INFORMATION

Device	Package
TJ4203GSF5-ADJ	SOT23-5L
TJ4203GSF5-X.X	
TJ4203GQ-ADJ	DFN2X2-6L
TJ4203GQ-X.X	
TJ4203GTF5-ADJ	SC70-5L
TJ4203GTF5-X.X	

X.X = Output Voltage = 1.0, 1.2, 1.8, 2.5, and 3.3

Absolute Maximum Ratings

CHARACTERISTIC	SYMBOL	MIN.	MAX.	UNIT
Input Supply Voltage (Survival)	V_{IN}	-	6.5	V
Enable Input Voltage (Survival)	V_{EN}	-	6.5	V
Maximum Output Current	I_{MAX}	-	300	mA
Lead Temperature (Soldering, 5 sec)	T_{SOL}		260	°C
Storage Temperature Range	T_{STG}	-65	150	°C
Operating Junction Temperature Range	T_{JOPR}	-40	125	°C

300mA Ultra Low Dropout Linear Regulator

TJ4203

Ordering Information

V _{OUT}	Package	Order No.	Description	Package Marking	Status
ADJ	SOT23-5L	TJ4203GSF5-ADJ	300mA, Adjustable, Enable	03GAD	Contact Us
	DFN2X2-6L	TJ4203GQ-ADJ	300mA, Adjustable, Enable	03GAD	Contact Us
	SC70-5L	TJ4203GTF-ADJ	300mA, Adjustable, Enable	03GAD	Contact Us
1.0V	SOT23-5L	TJ4203GSF5-1.0	300mA, Enable	03G10	Contact Us
	DFN2X2-6L	TJ4203GQ-1.0	300mA, Enable	03G10	Contact Us
	SC70-5L	TJ4203GTF-1.0	300mA, Enable	03G10	Contact Us
1.2V	SOT23-5L	TJ4203GSF5-1.2	300mA, Enable	03G12	Contact Us
	DFN2X2-6L	TJ4203GQ-1.2	300mA, Enable	03G12	Contact Us
	SC70-5L	TJ4203GTF-1.2	300mA, Enable	03G12	Contact Us
1.8V	SOT23-5L	TJ4203GSF5-1.8	300mA, Enable	03G18	Contact Us
	DFN2X2-6L	TJ4203GQ-1.8	300mA, Enable	03G18	Contact Us
	SC70-5L	TJ4203GTF-1.8	300mA, Enable	03G18	Contact Us
2.5V	SOT23-5L	TJ4203GSF5-2.5	300mA, Enable	03G25	Contact Us
	DFN2X2-6L	TJ4203GQ-2.5	300mA, Enable	03G25	Contact Us
	SC70-5L	TJ4203GTF-2.5	300mA, Enable	03G25	Contact Us
3.3V	SOT23-5L	TJ4203GSF5-3.3	300mA, Enable	03G33	Contact Us
	DFN2X2-6L	TJ4203GQ-3.3	300mA, Enable	03G33	Contact Us
	SC70-5L	TJ4203GTF-3.3	300mA, Enable	03G33	Contact Us

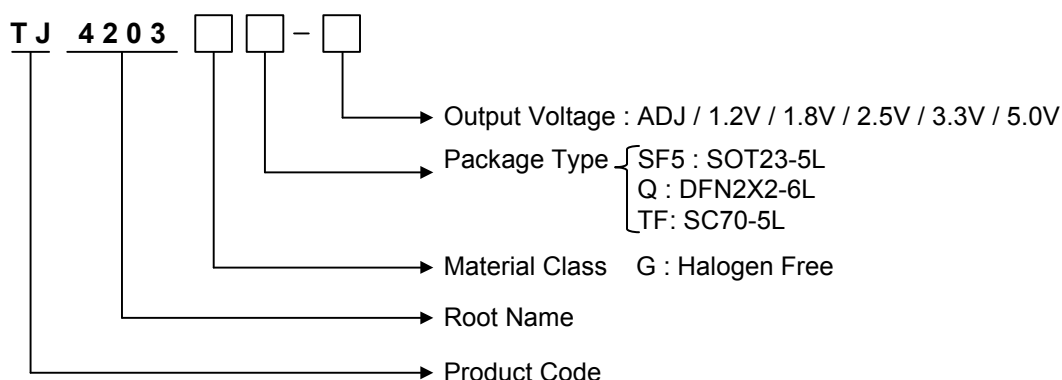

PIN CONFIGURATION

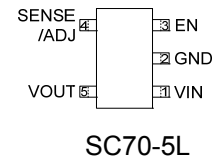
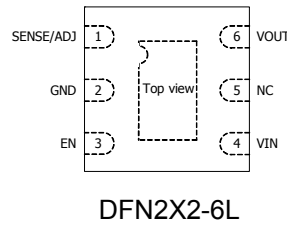
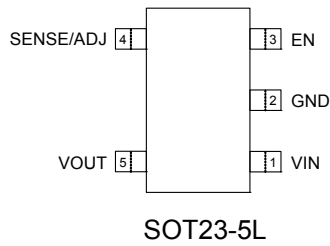

PIN DESCRIPTION

Pin No.	SOT23-5L / SC70-5L		DFN2X2-6L	
	Name	Function	Name	Function
1	V_{IN}	Input Supply	SENSE/ADJ	Remote Sense or Output Adjust
2	GND	Ground	GND	Ground
3	EN	Chip Enable	EN	Chip Enable
4	SENSE/ADJ	Remote Sense or Output Adjust	V_{IN}	Input Supply
5	V_{OUT}	Output Voltage	NC	No Internal Connection
6	-	-	V_{OUT}	Output Voltage

BASIC APPLICATION

Typical 5 Pin Application

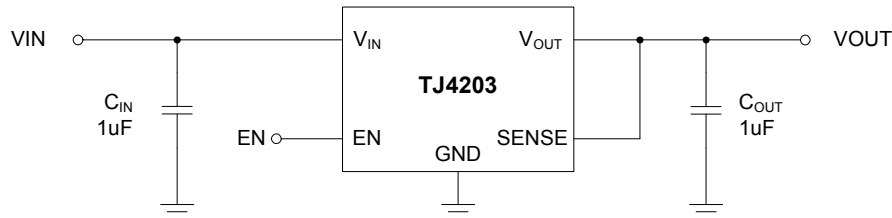

5 Pin Remote Load Sense Application

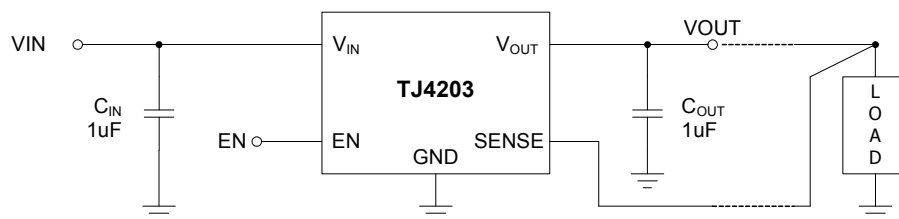

Typical Adjustable Version Application

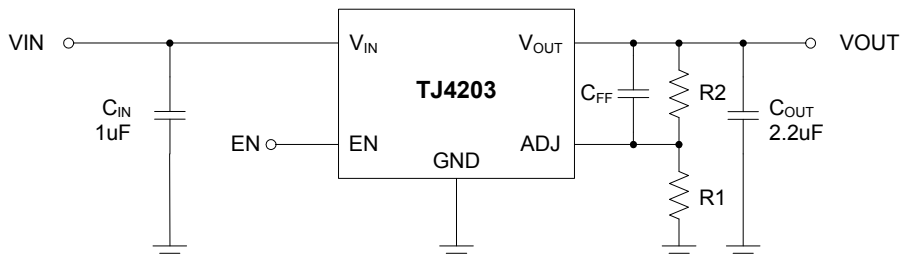

* TJ4203 can deliver a continuous current of 300mA over the full operating temperature. However, the output current is limited by the restriction of power dissipation which differs from packages. A heat sink may be required depending on the maximum power dissipation and maximum ambient temperature of application. With respect to the applied package, the maximum output current of 300mA may be still undeliverable.

* See Application Information.

ELECTRICAL CHARACTERISTICS^(Note 1)

Limits in standard typeface are for $T_J=25^\circ\text{C}$, and limits in **boldface type** apply over the **full operating temperature range**. Unless otherwise specified: $V_{IN}^{(Note 2)} = V_{O(NOM)} + 1\text{ V}$, $I_L = 10\text{ mA}$, $C_{IN} = 1\text{ }\mu\text{F}$, $C_{OUT} = 1\text{ }\mu\text{F}$, $V_{EN} = V_{IN} - 0.3\text{ V}$

PARAMETER	SYMBOL	TEST CONDITION	MIN.	TYP.	MAX.	UNIT	
Output Voltage Tolerance	V_O	$V_{OUT}+1\text{ V} < V_{IN} < 5.5\text{ V}$	-2 -3	0	2 3	%	
Adjustable Pin Voltage (ADJ version)	V_{ADJ}	$2.5\text{ V} < V_{IN} < 5.5\text{ V}$	0.784 0.776	0.8	0.816 0.824	V	
Line Regulation ^(Note 3)	ΔV_{LINE}	$V_{OUT}+1\text{ V} < V_{IN} < 5.5\text{ V}$	-	0.15	- 0.40	%/V	
Load Regulation ^(Note 3, 4)	ΔV_{LOAD}	$10\text{ mA} < I_L < 300\text{ mA}$	-	0.10	0.25 0.40	%	
Dropout Voltage ^(Note 5)	V_{DROP}	$I_L = 30\text{ mA}$	-	30	45 55	mV	
		$I_L = 300\text{ mA}$	-	300	400 500		
Ground Pin Current ^(Note 6)	I_{GND}	$I_L = 30\text{ mA}$	-	0.10	0.15 0.20	mA	
		$I_L = 300\text{ mA}$	-	0.15	0.20 0.25		
Ground Pin Current ^(Note 7)	I_{GND_OFF}	$V_{EN} < 0.2\text{ V}$	-	0.5	1 2	μA	
Power Supply Rejection Ratio	PSRR	$f = 1\text{ kHz}$	-	55	-	dB	
		$f = 1\text{ kHz}$, $C_{FF} = 0.1\text{ }\mu\text{F}$	-	60	-		
Thermal Shutdown Temperature	T_{SD}	-	-	165	-	$^\circ\text{C}$	
Enable threshold	Logic Low	V_{IL}	Output = Low	-	-	0.4	V
	Logic High	V_{IH}	Output = High	2.0	-	-	V
Enable Input Current	I_{EN}	$V_{EN} = V_{IN}$	-	0.1	- 1	μA	
Over Current Limit	I_{LIMIT}	-	500	-	-	mA	

Note 1. Stresses listed as the absolute maximum ratings may cause permanent damage to the device. These are for stress ratings. Functional operating of the device at these or any other conditions beyond those indicated in the operational sections of the specifications is not implied. Exposure to absolute maximum rating conditions for extended periods may remain possibly to affect device reliability.

Note 2. The minimum operating value for input voltage is equal to either $(V_{OUT,NOM} + V_{DROP})$ or 2.5V, whichever is greater.

Note 3. Output voltage line regulation is defined as the change in output voltage from the nominal value due to change in the input line voltage. Output voltage load regulation is defined as the change in output voltage from the nominal value due to change in load current.

Note 4. Regulation is measured at constant junction temperature by using a 10ms current pulse. Devices are tested for load regulation in the load range from 10mA to 300mA.

Note 5. Dropout voltage is defined as the minimum input to output differential voltage at which the output drops 2% below the nominal value. Dropout voltage specification applies only to output voltages of 2.5V and above. For output voltages below 2.5V, the dropout voltage is nothing but the input to output differential, since the minimum input voltage is 2.5V

Note 6. Ground current, or quiescent current, is the difference between input and output currents. It's defined by $I_{GND1} = I_{IN} - I_{OUT}$ under the given loading condition. The total current drawn from the supply is the sum of the load current plus the ground pin current.

Note 7. Ground current, or standby current, is the input current drawn by a regulator when the output voltage is disabled by an enable signal.

APPLICATION INFORMATION

Introduction

TJ4203 is intended for applications where high current capability and very low dropout voltage are required. It provides a simple, low cost solution that occupies very little PCB estate. Additional features include an enable pin to allow for a very low power consumption standby mode, an adjustable pin to provide a fully adjustable output voltage, and SENSE pin to provide better remote load regulation characteristics.

Component Selection

Input Capacitor :

A minimum of 1uF ceramic capacitor is recommended to be placed directly next to the V_{IN} Pin. It allows for the device being some distance from any bulk capacitor on the rail. Additionally, input droop due to load transients is reduced, improving load transient response. Additional capacitance may be added if required by the application.(See Fig.1)

Output Capacitor :

A minimum ceramic capacitor over than 1uF should be very closely placed to the output voltage pin of the TJ4203. Increasing capacitance will improve the overall transient response and stability.

Decoupling (Bypass) Capacitor :

In very electrically noisy environments, it is recommended that additional ceramic capacitors be placed from V_{IN} to GND. The use of multiple lower value ceramic capacitors in parallel with output capacitor also allows to achieve better transient performance and stability if required by the application.(See Fig.1)

Feed-Forward Capacitor

To get the higher PSRR than the inherent performance of TJ4203, it is recommended that additional ceramic feed-forward capacitor be placed from V_{OUT} pin to ADJ pin. The capacitance of feed-forward capacitor with range of 1nF to 100nF allows to achieve better PSRR performance when required by the application. In this case, over than 2.2uF output capacitor should be placed to the output voltage pin of the TJ4203.(See Fig.2)

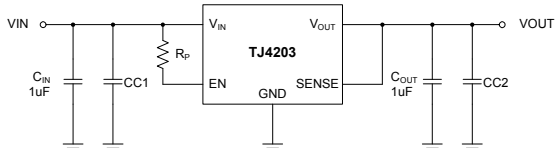

Fig. 1. Application with Decoupling Capacitor, CC1 & CC2

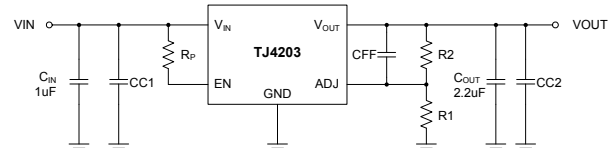

Fig. 2. Application with Feed-Forward Capacitor, CFF

Delayed Start-Up

When power sequence control is required or rising time of input supply voltage is over than 100usec, it is recommended to apply delayed start-up by using C_{delay} as shown in Fig. 3. It can adjust proper delay by R_p - C_{delay} time constant. And also it can prevent any unexpected transient characteristics at output voltage when the rising time of input supply voltage is as long as 100usec or longer.

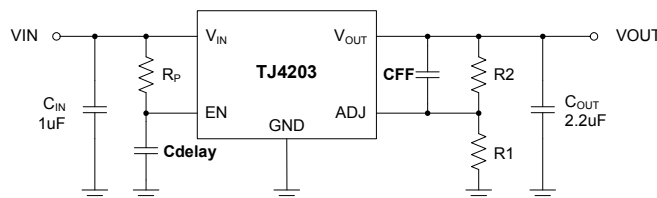

Fig. 3. Application with Delayed Start-Up

Output Adjustment (Adjustable Version)

An adjustable output device has output voltage range of 0.8V to 5.0V. The operating condition of V_{IN} and the operating characteristics of V_{OUT} depend on the dropout voltage performance in accordance with output load current. To obtain a desired output voltage, the following equation can be used with R1 resistor range of 100Ω to 50kΩ.

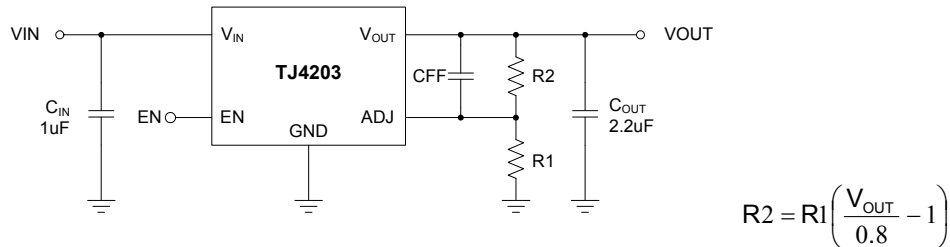

Fig. 4. Application for Adjustable Output Voltage

To enhance output stability, a feed-forward capacitor of 10nF to 1µF can be placed in series with V_{OUT} and ADJ. (Refer to "Component Selection" Section)

SENSE Pin

In applications where the regulator output is not very close to the load, the TJ4203 can provide better remote load regulation characteristics using the SENSE pin. TJ4203 regulates the voltage at the output pin. Hence, the voltage at the remote load will be lower than the voltage at the output pin as a value of the voltage drop across the trace series resistance. If the sense option pin is not required, the sense pin must be connected to the V_{OUT} pin. Connecting the sense pin to the remote load will provide regulation at the remote load because the TJ4203 regulates the voltage at the sense pin when the sense option pin is used.

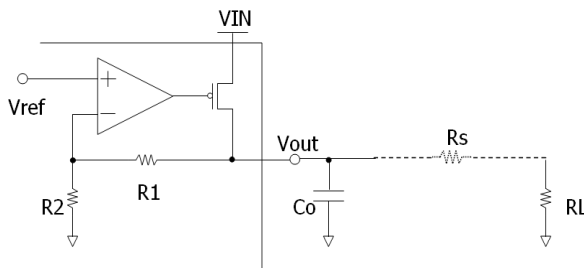

Fig. 5. Conventional Linear Regulator Application

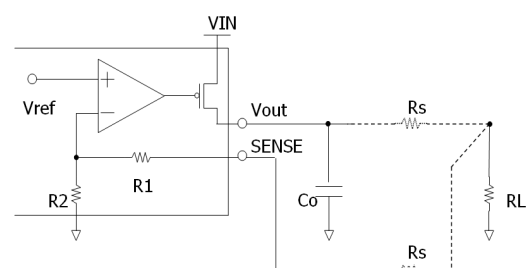

Fig.6. Remote Load Sense Application

Maximum Output Current Capability

The TJ4203 can deliver a continuous current of 300mA over the full operating junction temperature range. However, the output current is limited by the restriction of power dissipation which differs from packages. A heat sink may be required depending on the maximum power dissipation and maximum ambient temperature of application. With respect to the applied package, the maximum output current of 300mA may be still undeliverable due to the restriction of the power dissipation of TJ4203. Under all possible conditions, the junction temperature must be within the range specified under operating conditions.

The temperatures over the device are given by:

$$T_C = T_A + P_D \times \theta_{CA}$$

$$T_J = T_C + P_D \times \theta_{JC}$$

$$T_J = T_A + P_D \times \theta_{JA}$$

where T_J is the junction temperature, T_C is the case temperature, T_A is the ambient temperature, P_D is the total power dissipation of the device, θ_{CA} is the thermal resistance of case-to-ambient, θ_{JC} is the thermal resistance of junction-to-case, and θ_{JA} is the thermal resistance of junction to ambient.

The total power dissipation of the device is given by:

$$\begin{aligned} P_D &= P_{IN} - P_{OUT} = (V_{IN} \times I_{IN}) - (V_{OUT} \times I_{OUT}) \\ &= (V_{IN} \times (I_{OUT} + I_{GND})) - (V_{OUT} \times I_{OUT}) = (V_{IN} - V_{OUT}) \times I_{OUT} + V_{IN} \times I_{GND} \end{aligned}$$

where I_{GND} is the operating ground current of the device which is specified at the Electrical Characteristics. The maximum allowable temperature rise (T_{Rmax}) depends on the maximum ambient temperature (T_{Amax}) of the application, and the maximum allowable junction temperature (T_{Jmax}):

$$T_{Rmax} = T_{Jmax} - T_{Amax}$$

The maximum allowable value for junction-to-ambient thermal resistance, θ_{JA} , can be calculated using the formula:

$$\theta_{JA} = T_{Rmax} / P_D$$

TYPICAL OPERATING CHARACTERISTICS

Test Circuit

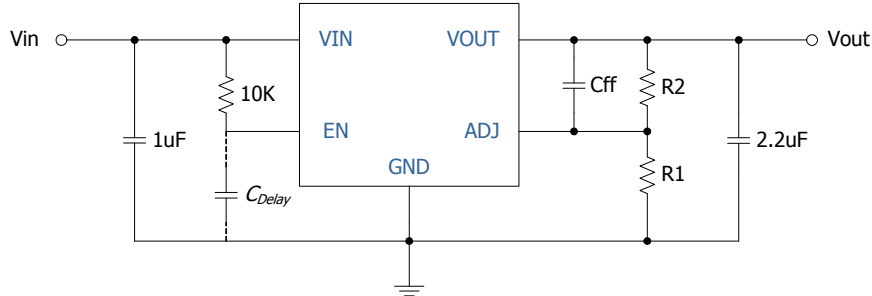

Case 1 (VIN = 3.3V, VOUT = 2.5V)

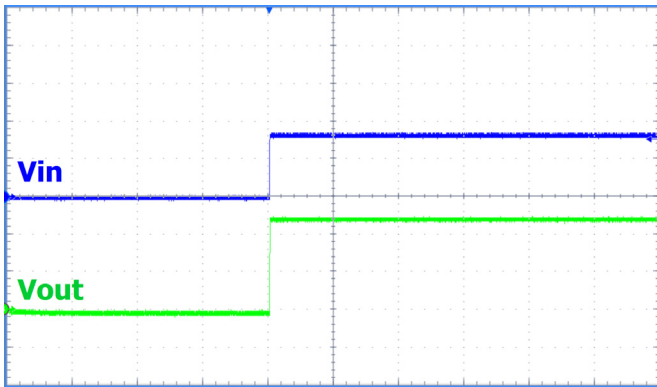

VIN : 2.0V/div, VOUT : 1.0V/div, Time : 500ms/div

Start Up @ Iout=0A
(Cff=10nF, R2=51KΩ, R1=24KΩ)

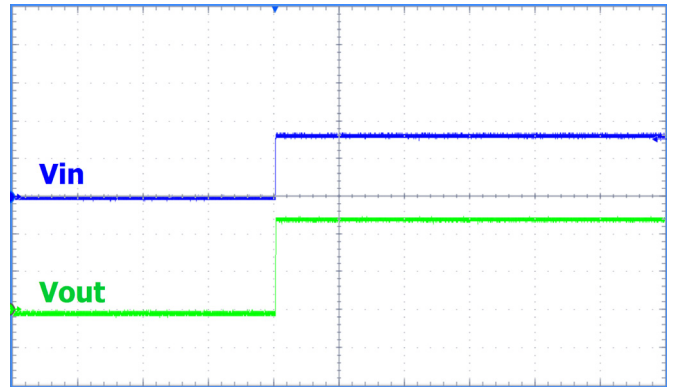

VIN : 2.0V/div, VOUT : 1.0V/div, Time : 500ms/div

Start Up @ Iout=300mA
(Cff=10nF, R2=51KΩ, R1=24KΩ)

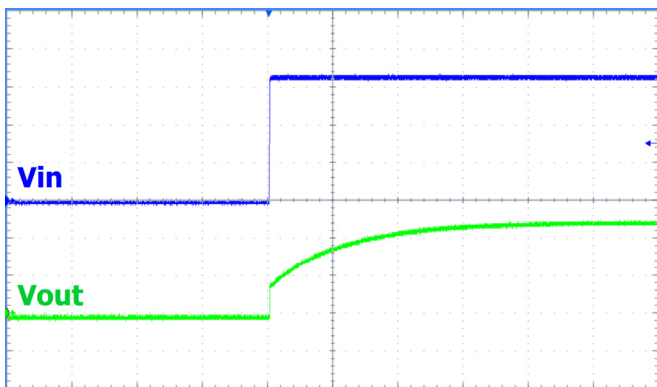

VIN : 1.0V/div, VOUT : 1.0V/div, Time : 50ms/div

Start Up @ Iout=0A
(Cff=1uF, R2=51KΩ, R1=24KΩ)

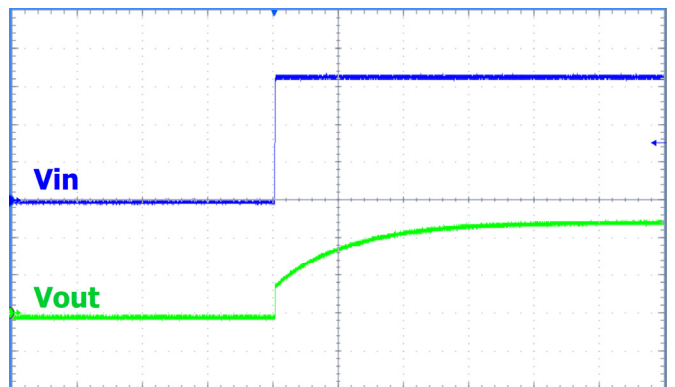

VIN : 1.0V/div, VOUT : 1.0V/div, Time : 50ms/div

Start Up @ Iout=300mA
(Cff=1uF, R2=51KΩ, R1=24KΩ)

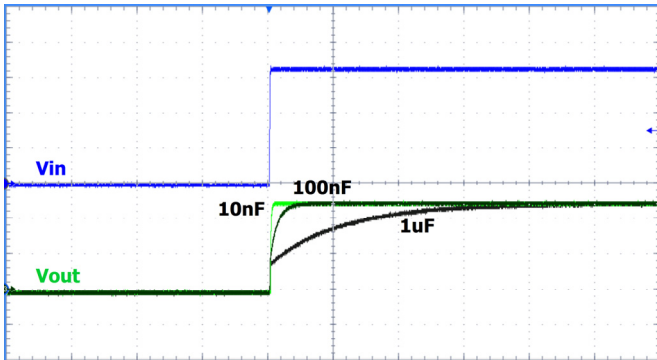

VIN : 1.0V/div, VOUT : 1.0V/div, Time : 50ms/div

Start Up @ Iout=300mA
(Cff is varied, R2=51KΩ, R1=24KΩ)

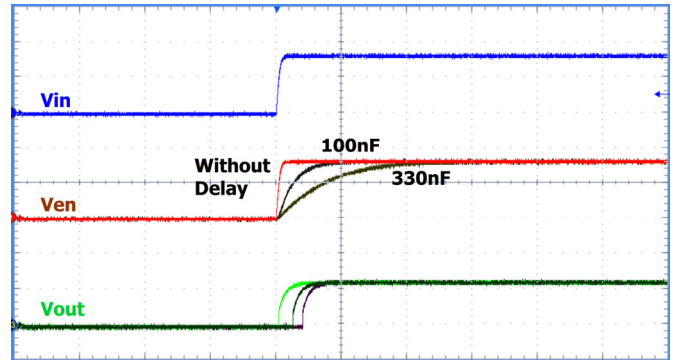

VIN : 2.0V/div, VOUT : 2.0V/div, Time : 5ms/div

Start Up @ Iout=10mA
(Cff is varied, R2=51KΩ, R1=24KΩ)

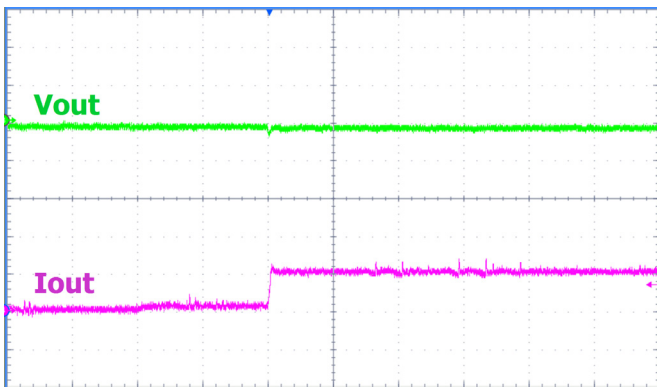

VIN : 20mV/div, IOUT : 300mA/div, Time : 500us/div

Load Transient Response
(Cff =10nF, R2=51KΩ, R1=24KΩ)

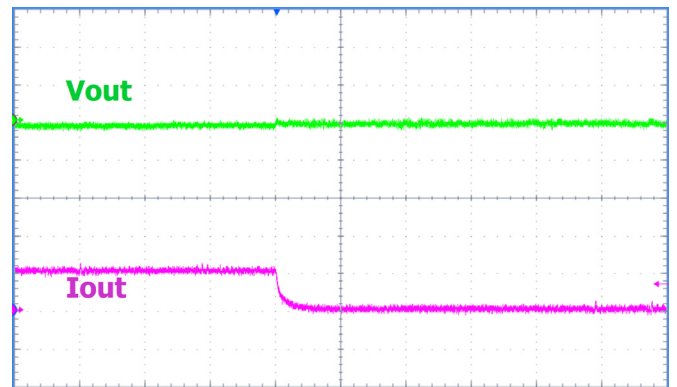

VIN : 20mV/div, IOUT : 300mA/div, Time : 500us/div

Load Transient Response
(Cff =10nF, R2=51KΩ, R1=24KΩ)

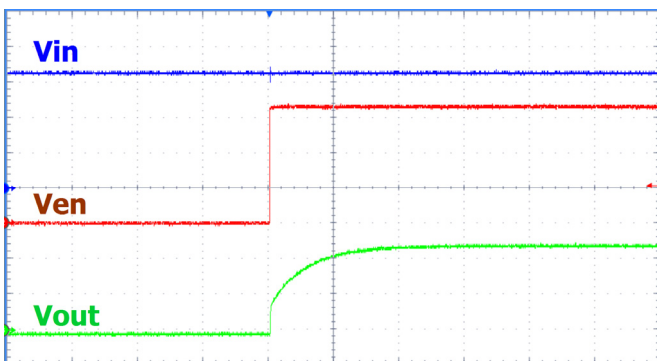

VIN : 1V/div, VEN: 1V/div, VOUT : 1V/div, Time : 1ms/div

Start Up @ Iout=0A
(Cff=10nF, R2=51KΩ, R1=24KΩ)

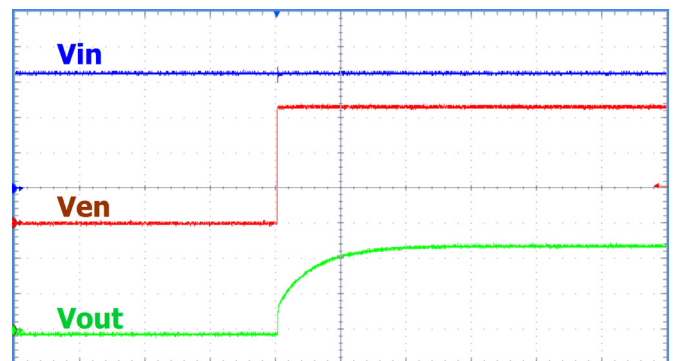

VIN : 1V/div, VEN: 1V/div, VOUT : 1V/div, Time : 1ms/div

Start Up @ Iout=300mA
(Cff=10nF, R2=51KΩ, R1=24KΩ)