

# Two-4-One™ Power Transformers

## Chassis Mount

### Split Bobbin with High Isolation



Signal's 241 transformers use a split bobbin that provides superior isolation and low capacitive coupling.

#### General Specifications

- Power - 2.4 VA to 100 VA
- Dielectric Strength - 2500 VRMS Hipot
- Primaries - Single or dual primaries (115V or 115/230 V - 50/60 Hz)
- Secondary - Single center tapped secondary
- Terminals - Solder lug / quick connect type terminals
- Insulation - Class B (130° C) UL 1446 E66312

#### Agency Certifications

- UL recognized to UL 506, File # E63829
- CSA certified to C22.2 #66, File # 221070



Part Number		Secondary RMS Rating	Part Number		Secondary RMS Rating
Single 115V	Dual 115/230V		Single 115V	Dual 115/230V	
241-3-10	Not Available	10VCT @ 0.25A	241-3-28	Not Available	28VCT @ 0.085A
241-4-10	DP-241-4-10	10VCT @ 0.60A	241-4-28	DP-241-4-28	28VCT @ 0.20A
241-5-10	DP-241-5-10	10VCT @ 1.2A	241-5-28	DP-241-5-28	28VCT @ 0.42A
241-6-10	DP-241-6-10	10VCT @ 3.0A	241-6-28	DP-241-6-28	28VCT @ 1.1A
241-7-10	DP-241-7-10	10VCT @ 5.0A	241-7-28	DP-241-7-28	28VCT @ 2.0A
241-8-10	DP-241-8-10	10VCT @ 10A	241-8-28	DP-241-8-28	28VCT @ 3.6A
241-3-12	Not Available	12.6VCT @ 0.20A	241-3-36	Not Available	36VCT @ 0.065A
241-4-12	DP-241-4-12	12.6VCT @ 0.50A	241-4-36	DP-241-4-36	36VCT @ 0.17A
241-5-12	DP-241-5-12	12.6VCT @ 1.0A	241-5-36	DP-241-5-36	36VCT @ 0.35A
241-6-12	DP-241-6-12	12.6VCT @ 2.5A	241-6-36	DP-241-6-36	36VCT @ 0.85A
241-7-12	DP-241-7-12	12.6VCT @ 4.0A	241-7-36	DP-241-7-36	36VCT @ 1.5A
241-8-12	DP-241-8-12	12.6VCT @ 8.0A	241-8-36	DP-241-8-36	36VCT @ 2.8A
241-3-16	Not Available	16VCT @ 0.15A	241-3-48	Not Available	48VCT @ 0.05A
241-4-16	DP-241-4-16	16VCT @ 0.40A	241-4-48	DP-241-4-48	48VCT @ 0.125A
241-5-16	DP-241-5-16	16VCT @ 0.80A	241-5-48	DP-241-5-48	48VCT @ 0.25A
241-6-16	DP-241-6-16	16VCT @ 2.0A	241-6-48	DP-241-6-48	48VCT @ 0.63A
241-7-16	DP-241-7-16	16VCT @ 3.5A	241-7-48	DP-241-7-48	48VCT @ 1.2A
241-8-16	DP-241-8-16	16VCT @ 6.25A	241-8-48	DP-241-8-48	48VCT @ 2.0A
241-3-20	Not Available	20VCT @ 0.12A	241-3-56	Not Available	56VCT @ 0.045A
241-4-20	DP-241-4-20	20VCT @ 0.30A	241-4-56	DP-241-4-56	56VCT @ 0.11A
241-5-20	DP-241-5-20	20VCT @ 0.60A	241-5-56	DP-241-5-56	56VCT @ 0.22A
241-6-20	DP-241-6-20	20VCT @ 1.5A	241-6-56	DP-241-6-56	56VCT @ 0.54A
241-7-20	DP-241-7-20	20VCT @ 2.8A	241-7-56	DP-241-7-56	56VCT @ 1.00A
241-8-20	DP-241-8-20	20VCT @ 5.0A	241-8-56	DP-241-8-56	56VCT @ 1.8A
241-3-24	Not Available	24VCT @ 0.10A	241-3-120	Not Available	120VCT @ 0.02A
241-4-24	DP-241-4-24	24VCT @ 0.25A	241-4-120	DP-241-4-120	120VCT @ 0.05A
241-5-24	DP-241-5-24	24VCT @ 0.50A	241-5-120	DP-241-5-120	120VCT @ 0.10A
241-6-24	DP-241-6-24	24VCT @ 1.25A	241-6-120	DP-241-6-120	120VCT @ 0.25A
241-7-24	DP-241-7-24	24VCT @ 2.4A	241-7-120	DP-241-7-120	120VCT @ 0.50A
241-8-24	DP-241-8-24	24VCT @ 4.0A	241-8-120	DP-241-8-120	120VCT @ 0.85A

©2006 Signal Transformer Inc. Specifications subject to change without notice. 07.06

# Two-4-One™ Power Transformers

## Chassis Mount

### Split Bobbin with High Isolation



Size	VA	Dimensions						Weight
		L	W	H	A	B	ML typ	
		Inches (mm)						
3	2.4	2.07 (52.6)	1.17 (29.6)	1.23 (31.2)	1.62 (41.3)	0.59 (15)	1.75 (44.5)	0.25 (0.11)
4	6	2.37 (60.3)	1.31 (33.3)	1.43 (36.2)	1.71 (43.4)	0.72 (18.3)	2.00 (50.8)	0.44 (0.20)
5	12	2.81 (71.4)	1.43 (36.3)	1.69 (42.8)	1.97 (49.9)	0.89 (22.6)	2.37 (60.3)	0.7 (0.32)
6	30	3.25 (82.6)	1.74 (44.3)	1.96 (49.8)	2.35 (59.3)	1.14 (28.9)	2.81 (71.4)	1.1 (0.50)
7	56	3.68 (93.7)	1.94 (49.2)	2.28 (57.8)	2.70 (68.4)	1.14 (28.9)	3.12 (79.4)	1.7 (0.77)
8	100	4.03 (102.4)	2.30 (58.5)	2.67 (67.7)	3.08 (78.2)	1.43 (36.2)	3.63 (92)	2.75 (1.25)

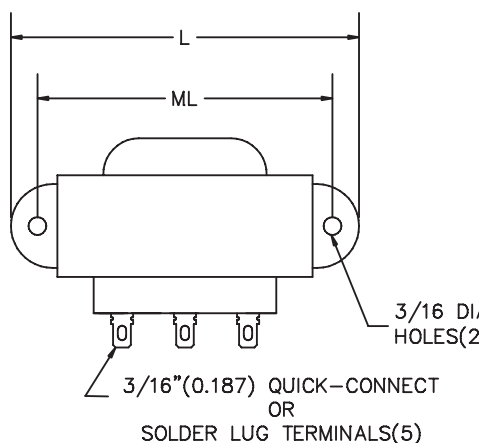

TERMINAL DETAIL

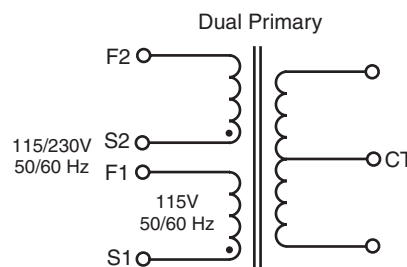
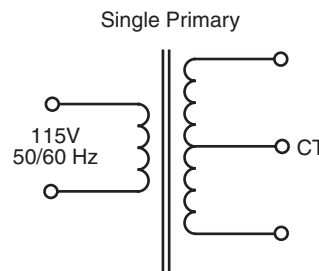
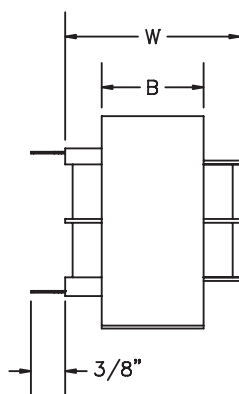
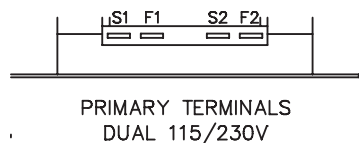
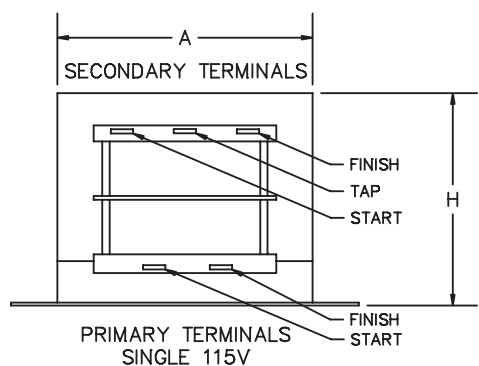
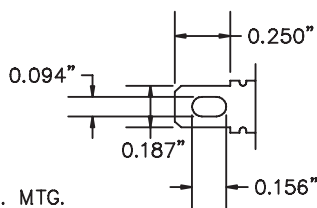

• Indicates like polarity

©2006 Signal Transformer Inc. Specifications subject to change without notice. 07.06