

SPECIFICATIONS

Mechanical

Contact Retention Force: 1.36 kg Min.

Electrical

Voltage Rating: 125V

Current Rating: 3A Per Pin Min.

Dielectric Withstanding Voltage: 1500 RMS

Insulation Resistance: 5000MW min.

Physical

Housing: High Temperature, UL 94V-0 Rated In Black Color

Contact: Brass

Plating: See "ORDERING INFORMATION"

Operating Temperature: -55 to +105

Header Connector

HD22 Series

R/A, T/H Type

Receptacle

2.50mm [.098] Pitch

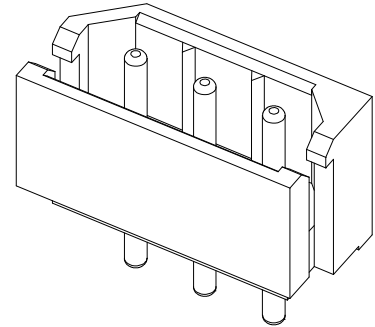

DRAWING

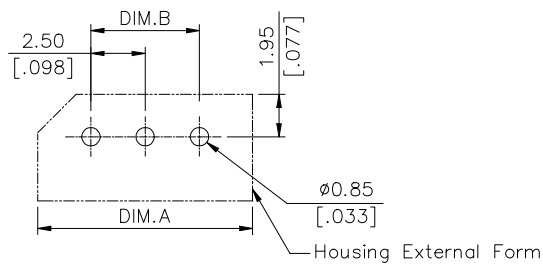
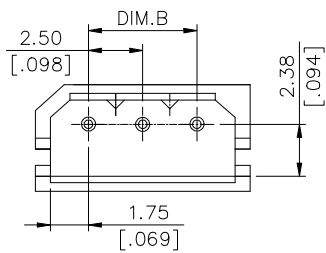

RECOMMENDED P.C.B. LAYOUT

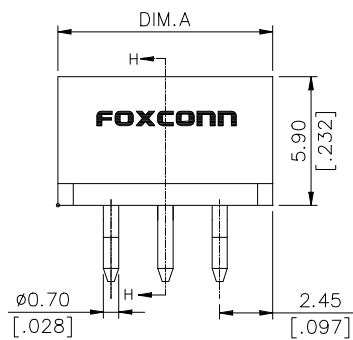

TYPE II (FOR 3 POS. OR LARGER)

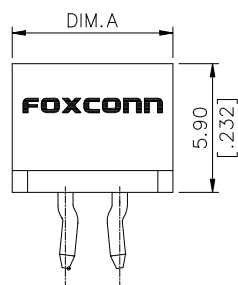

TYPE I (FOR 2 POS.)

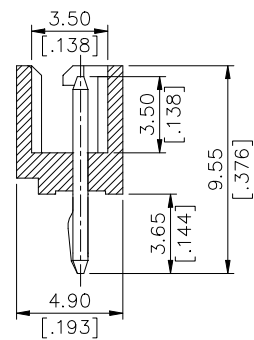

SECH-H

ORDERING INFORMATION

PRODUCT NO.: H D 2 2 * * * - * *

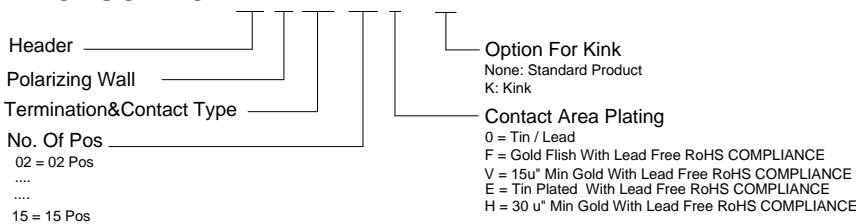

See The Attachment I

See The Attachment I :

HD2215*-***	15	39.90 [1.572]	35.00 [1.379]
HD2214*-***	14	37.40 [1.474]	32.50 [1.281]
HD2213*-***	13	34.90 [1.375]	30.00 [1.182]
HD2212*-***	12	32.40 [1.277]	27.50 [1.084]
HD2211*-***	11	29.90 [1.178]	25.00 [.985]
HD2210*-***	10	27.40 [1.08]	22.50 [.887]
HD2209*-***	09	24.90 [.981]	20.00 [.788]
HD2208*-***	08	22.40 [.883]	17.50 [.69]
HD2207*-***	07	19.90 [.784]	15.00 [.591]
HD2206*-***	06	17.40 [.686]	12.50 [.493]
HD2205*-***	05	14.90 [.587]	10.00 [.394]
HD2204*-***	04	12.40 [.489]	7.50 [.296]
HD2203*-***	03	9.90 [.39]	5.00 [.197]
HD2202*-***	02	7.40 [.292]	2.50 [.098]
P/N	POS.	DIM. A	DIM. B