



HE8551

PNP SILICON TRANSISTOR

LOW VOLTAGE HIGH CURRENT SMALL SIGNAL PNP TRANSISTOR

DESCRIPTION

The UTC **HE8551** is a low voltage high current small signal PNP transistor, designed for Class B push-pull 2W audio amplifier for portable radio and general purpose applications.

FEATURES

- * Collector current up to 1.5A
- * Collector-emitter voltage up to 25 V
- * Complimentary to UTC **HE8051**

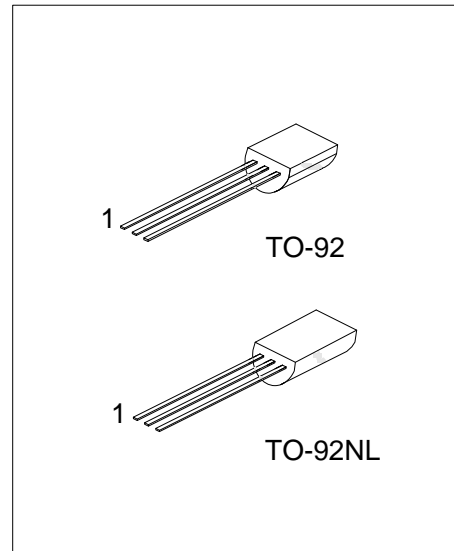

Lead-free: HE8551L
Halogen-free: HE8551G

ORDERING INFORMATION

Ordering Number			Package	Pin Assignment			Packing
Normal	Lead Free Plating	Halogen Free		1	2	3	
HE8551-x-T92-B	HE8551L-x-T92-B	HE8551G-x-T92-B	TO-92	E	B	C	Tape Box
HE8551-x-T92-K	HE8551L-x-T92-K	HE8551G-x-T92-K	TO-92	E	B	C	Bulk
HE8551-x-T9N-B	HE8551L-x-T9N-B	HE8551G-x-T9N-B	TO-92NL	E	B	C	Tape Box
HE8551-x-T9N-K	HE8551L-x-T9N-K	HE8551G-x-T9N-K	TO-92NL	E	B	C	Bulk

<p>HE8551L-x-T92-B</p> <p>(1) Packing Type (2) Package Type (3) Rank (4) Lead Plating</p>	<p>(1) B: Tape Box, K: Bulk (2) T92: TO-92, T9N: TO-92NL (3) x: refer to Classification of h_{FE2} (4) G: Halogen Free, L: Lead Free, Blank: Pb/Sn</p>
---	---

■ ABSOLUTE MAXIMUM RATINGS (Ta=25°C, unless otherwise specified)

PARAMETER	SYMBOL	RATINGS	UNIT
Collector-Base Voltage	V _{CBO}	-40	V
Collector-Emitter Voltage	V _{CEO}	-25	V
Emitter-Base Voltage	V _{EBO}	-6	V
Collector Dissipation (Ta=25°C)	P _C	1	W
Collector Current	I _C	-1.5	A
Junction Temperature	T _J	+150	°C
Storage Temperature	T _{STG}	-65 ~ +150	°C

Note: Absolute maximum ratings are those values beyond which the device could be permanently damaged. Absolute maximum ratings are stress ratings only and functional device operation is not implied.

■ ELECTRICAL CHARACTERISTICS (T_J=25°C, unless otherwise specified)

PARAMETER	SYMBOL	TEST CONDITIONS	MIN	TYP	MAX	UNIT
Collector-Base Breakdown Voltage	BV _{CBO}	I _C =-100μA, I _E =0	-40			V
Collector-Emitter Breakdown Voltage	BV _{CEO}	I _C =-2mA, I _B =0	-25			V
Emitter-Base Breakdown Voltage	BV _{EBO}	I _E =-100μA, I _C =0	-6			V
Collector Cut-Off Current	I _{CBO}	V _{CB} =-35V, I _E =0			-100	nA
Emitter Cut-Off Current	I _{EBO}	V _{EB} =-6V, I _C =0			-100	nA
DC Current Gain	h _{FE1}	V _{CE} =-1V, I _C =-5mA	45	170		
	h _{FE2}	V _{CE} =-1V, I _C =-100mA	85	160	500	
	h _{FE3}	V _{CE} =-1V, I _C =-800mA	40	80		
Collector-Emitter Saturation Voltage	V _{CE(SAT)}	I _C =-800mA, I _B =-80mA		-0.28	-0.5	V
Base-Emitter Saturation Voltage	V _{BE(SAT)}	I _C =-800mA, I _B =-80mA		-0.98	-1.2	V
Base-Emitter Voltage	V _{BE}	V _{CE} =-1V, I _C =-10mA		-0.66	-1.0	V
Current Gain Bandwidth Product	f _T	V _{CE} =-10V, I _C =-50mA	100	190		MHz
Output Capacitance	C _{ob}	V _{CB} =-10V, I _E =0, f=1MHz		9.0		pF

■ CLASSIFICATION OF h_{FE2}

RANK	C	D	E
RANGE	120-200	160-300	250-500

■ TYPICAL CHARACTERISTICS

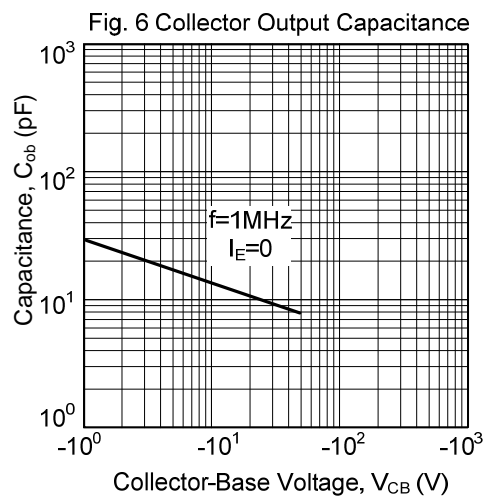
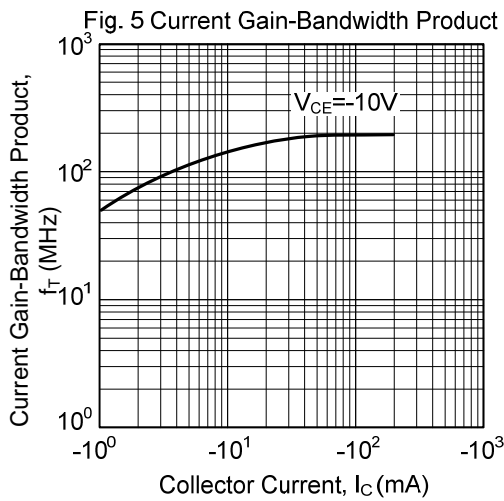
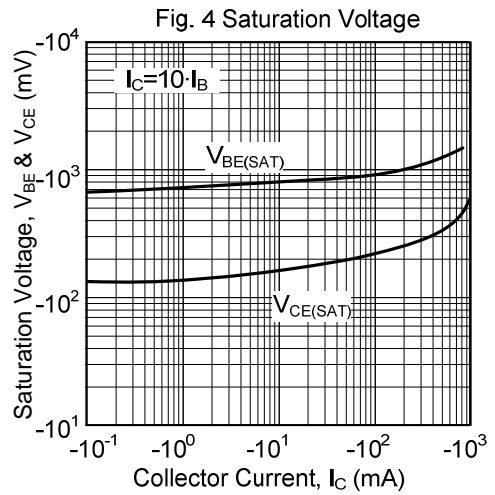
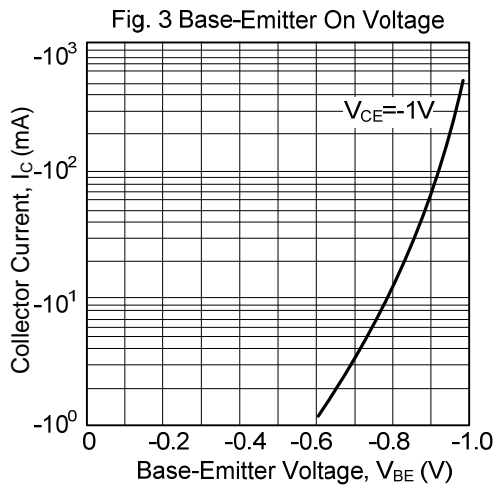
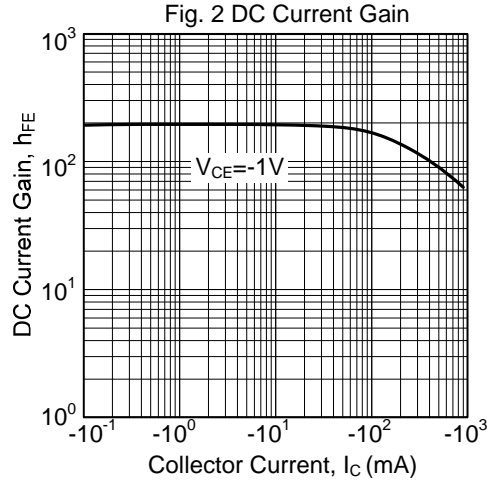
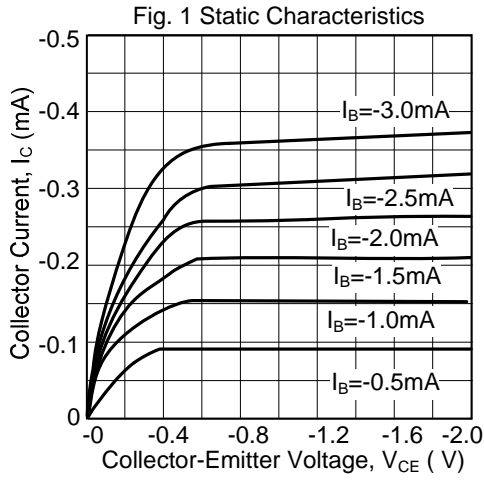

UTC assumes no responsibility for equipment failures that result from using products at values that exceed, even momentarily, rated values (such as maximum ratings, operating condition ranges, or other parameters) listed in products specifications of any and all UTC products described or contained herein. UTC products are not designed for use in life support appliances, devices or systems where malfunction of these products can be reasonably expected to result in personal injury. Reproduction in whole or in part is prohibited without the prior written consent of the copyright owner. The information presented in this document does not form part of any quotation or contract, is believed to be accurate and reliable and may be changed without notice.