

**Precision Low Power FGA™ Voltage References**

The ISL60002 FGA™ voltage references are very high precision analog voltage references fabricated in Intersil's proprietary Floating Gate Analog technology and feature low supply voltage operation at ultra-low 400nA operating current.

Additional features include guaranteed initial accuracy as low as ±1.0mV, @ 20ppm/°C temperature coefficient and long-term stability of <<10ppm/√1kHrs. The initial accuracy and thermal stability performance of the ISL60002 family plus the low supply voltage and 400nA power consumption eliminates the need to compromise thermal stability for reduced power consumption making it an ideal companion to high resolution, low power data conversion systems.

**Features**

- Reference Voltages . . .1.024V, 1.2V, 1.25V, 1.8V, 2.5V and 3.3V
- Absolute Initial Accuracy Options
  - . . . . . ±1.0mV, ±2.5mV, and ±5.0mV
- Supply Voltage Range
  - ISL60002-10, -11, -12, -18, -20, -25 . . . . . 2.7V to 5.5V
  - ISL60002-33 . . . . . 3.5V to 5.5V
- Ultra-Low Supply Current . . . . . 350nA typ
- Low 20ppm/°C Temperature Coefficient
- 10ppm/√1kHrs. Long Term Stability
- I<sub>SOURCE</sub> and I<sub>SINK</sub> = 7mA
- I<sub>SOURCE</sub> and I<sub>SINK</sub> = 20mA for ISL60002-33 only
- ESD Protection. . . . . 5kV (Human Body Model)
- Standard 8 Ld SOIC and 3 Ld SOT-23 Packaging
- operating Temperature Range
  - ISL60002-10, -11, -12, -18, -20, -25 . . . . -40°C to +85°C
  - ISL60002-33 . . . . . -40°C to +105°C
- Pb-Free Plus Anneal Available (RoHS Compliant)

**Applications**

- High Resolution A/Ds and D/As
- Digital Meters
- Bar Code Scanners
- Mobile Communications
- PDA's and Notebooks
- Medical Systems

**Typical Application**

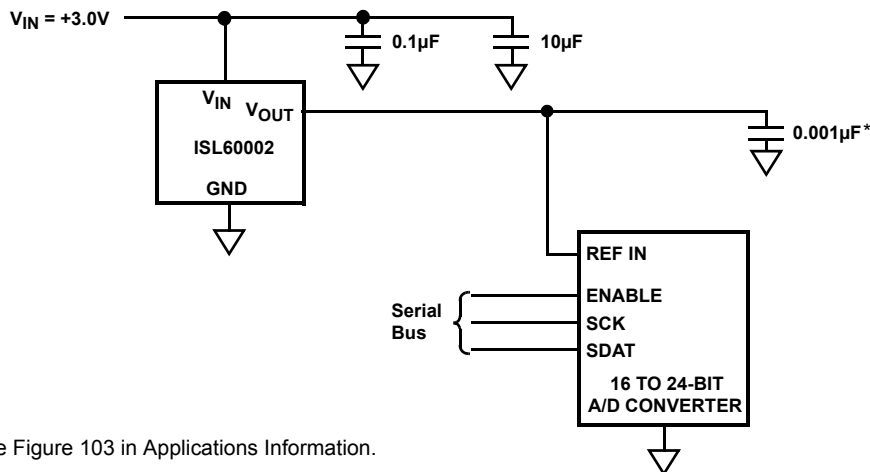

\*Also see Figure 103 in Applications Information.

**Table of Contents**

Typical Application..... 1

Pinouts ..... 3

Pin Descriptions ..... 3

Ordering Information ..... 3

Absolute Maximum Ratings..... 5

Electrical Specifications

    ISL60002-10,  $V_{OUT} = 1.024V$  ..... 5

    ISL60002-11,  $V_{OUT} = 1.200V$  ..... 5

    ISL60002-12,  $V_{OUT} = 1.250V$  ..... 5

    ISL60002-18,  $V_{OUT} = 1.800V$  ..... 6

    ISL60002-20,  $V_{OUT} = 2.048V$  ..... 6

    ISL60002-25,  $V_{OUT} = 2.500V$  ..... 6

    ISL60002-33,  $V_{OUT} = 3.300V$  ..... 6

Common Electrical Specifications

    ISL60002-10, -11, -12, -18, -20, and -25 ..... 7

Typical Performance Characteristic Curves

    ISL60002,  $V_{OUT} = 1.024V$  ..... 8

    ISL60002,  $V_{OUT} = 1.20V$  ..... 10

    ISL60002,  $V_{OUT} = 1.25V$  ..... 13

    ISL60002,  $V_{OUT} = 1.8V$  ..... 16

    ISL60002,  $V_{OUT} = 2.048V$  ..... 18

    ISL60002,  $V_{OUT} = 2.50V$  ..... 21

    ISL60002,  $V_{OUT} = 3.3V$  ..... 24

Applications Information..... 27

Typical Application Circuits..... 29

Packaging Information..... 30

**Pinouts**

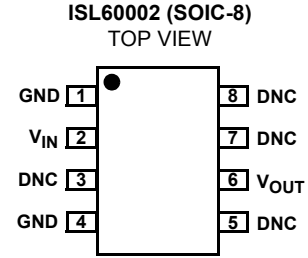
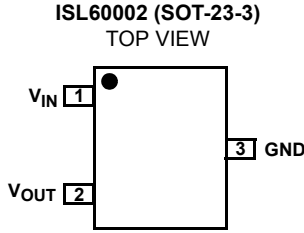

**Pin Descriptions**

PIN NAME	DESCRIPTION
GND	Ground Connection
$V_{IN}$	Power Supply Input Connection
$V_{OUT}$	Voltage Reference Output Connection
DNC	Do Not Connect; Internal Connection – Must Be Left Floating

**Ordering Information**

PART NUMBER	PART MARKING	$V_{OUT}$ (V)	GRADE	TEMP. RANGE (°C)	PACKAGE
<b>3 LD SOT-23</b>					
ISL60002BIH310Z-TK (Note)		1.024	$\pm 1.0\text{mV}$ , 20ppm/°C	-40 to 85	3 Ld SOT-23 (Pb-free)
ISL60002CIH310Z-TK (Note)		1.024	$\pm 2.5\text{mV}$ , 20ppm/°C	-40 to 85	3 Ld SOT-23 (Pb-free)
ISL60002DIH310Z-TK (Note)		1.024	$\pm 5.0\text{mV}$ , 20ppm/°C	-40 to 85	3 Ld SOT-23 (Pb-free)
ISL60002BIH311Z-TK (Note)	APH	1.200	$\pm 1.0\text{mV}$ , 20ppm/°C	-40 to 85	3 Ld SOT-23 (Pb-free)
ISL60002CIH311Z-TK (Note)	AOH	1.200	$\pm 2.5\text{mV}$ , 20ppm/°C	-40 to 85	3 Ld SOT-23 (Pb-free)
ISL60002DIH311Z-TK (Note)	AOY	1.200	$\pm 5.0\text{mV}$ , 20ppm/°C	-40 to 85	3 Ld SOT-23 (Pb-free)
ISL60002BIH312-TK	AIL	1.250	$\pm 1.0\text{mV}$ , 20ppm/°C	-40 to 85	3 Ld SOT-23
ISL60002BIH312Z-TK (Note)		1.250	$\pm 1.0\text{mV}$ , 20ppm/°C	-40 to 85	3 Ld SOT-23 (Pb-free)
ISL60002CIH312-TK	AIN	1.250	$\pm 2.5\text{mV}$ , 20ppm/°C	-40 to 85	3 Ld SOT-23
ISL60002CIH312Z-TK (Note)		1.250	$\pm 2.5\text{mV}$ , 20ppm/°C	-40 to 85	3 Ld SOT-23 (Pb-free)
ISL60002DIH312-TK	AIP	1.250	$\pm 5.0\text{mV}$ , 20ppm/°C	-40 to 85	3 Ld SOT-23
ISL60002DIH312Z-TK (Note)		1.250	$\pm 5.0\text{mV}$ , 20ppm/°C	-40 to 85	3 Ld SOT-23 (Pb-free)
ISL60002BIH318Z-TK (Note)		1.800	$\pm 1.0\text{mV}$ , 20ppm/°C	-40 to 85	3 Ld SOT-23 (Pb-free)
ISL60002CIH318Z-TK (Note)		1.800	$\pm 2.5\text{mV}$ , 20ppm/°C	-40 to 85	3 Ld SOT-23 (Pb-free)
ISL60002DIH318Z-TK (Note)		1.800	$\pm 5.0\text{mV}$ , 20ppm/°C	-40 to 85	3 Ld SOT-23 (Pb-free)
ISL60002BIH320Z-TK (Note)		2.048	$\pm 1.0\text{mV}$ , 20ppm/°C	-40 to 85	3 Ld SOT-23 (Pb-free)
ISL60002CIH320Z-TK (Note)		2.048	$\pm 2.5\text{mV}$ , 20ppm/°C	-40 to 85	3 Ld SOT-23 (Pb-free)
ISL60002DIH320Z-TK (Note)		2.048	$\pm 5.0\text{mV}$ , 20ppm/°C	-40 to 85	3 Ld SOT-23 (Pb-free)
ISL60002BIH325-TK	AIK	2.500	$\pm 1.0\text{mV}$ , 20ppm/°C	-40 to 85	3 Ld SOT-23
ISL60002BIH325Z-TK (Note)		2.500	$\pm 1.0\text{mV}$ , 20ppm/°C	-40 to 85	3 Ld SOT-23 (Pb-free)
ISL60002CIH325-TK	AIM	2.500	$\pm 2.5\text{mV}$ , 20ppm/°C	-40 to 85	3 Ld SOT-23
ISL60002CIH325Z-TK (Note)		2.500	$\pm 2.5\text{mV}$ , 20ppm/°C	-40 to 85	3 Ld SOT-23 (Pb-free)
ISL60002DIH325-TK	AIO	2.500	$\pm 5.0\text{mV}$ , 20ppm/°C	-40 to 85	3 Ld SOT-23

**Ordering Information** (Continued)

PART NUMBER	PART MARKING	V <sub>OUT</sub> (V)	GRADE	TEMP. RANGE (°C)	PACKAGE
ISL60002DIH325Z-TK (Note)		2.500V	±5.0mV, 20ppm/°C	-40 to 85	3 Ld SOT-23 (Pb-free)
ISL60002BAH333Z-TK (Note)	AOP	3.300V	±1.0mV, 20ppm/°C	-40 to 105	3 Ld SOT-23 (Pb-free)
ISL60002CAH333Z-TK (Note)	AOU	3.300V	±2.5mV, 20ppm/°C	-40 to 105	3 Ld SOT-23 (Pb-free)
ISL60002DAH333Z-TK (Note)	APC	3.300V	±5.0mV, 20ppm/°C	-40 to 105	3 Ld SOT-23 (Pb-free)
<b>8 LD SOIC</b>					
ISL60002BIB812*	60002BI 12	1.250V	±1.0mV, 20ppm/°C	-40 to 85	8 Ld SOIC
ISL60002CIB812*	60002CI 12	1.250V	±2.5mV, 20ppm/°C	-40 to 85	8 Ld SOIC
ISL60002DIB812*	60002DI 12	1.250V	±5.0mV, 20ppm/°C	-40 to 85	8 Ld SOIC
ISL60002BIB825*	60002BI 25	2.500V	±1.0mV, 20ppm/°C	-40 to 85	8 Ld SOIC
ISL60002CIB825*	60002CI 25	2.500V	±2.5mV, 20ppm/°C	-40 to 85	8 Ld SOIC
ISL60002DIB825*	60002DI 25	2.500V	±5.0mV, 20ppm/°C	-40 to 85	8 Ld SOIC

\*Add "TK" suffix for tape and reel.

NOTE: Intersil Pb-free plus anneal products employ special Pb-free material sets; molding compounds/die attach materials and 100% matte tin plate termination finish, which are RoHS compliant and compatible with both SnPb and Pb-free soldering operations. Intersil Pb-free products are MSL classified at Pb-free peak reflow temperatures that meet or exceed the Pb-free requirements of IPC/JEDEC J STD-020.

# ISL60002

## Absolute Maximum Ratings

Storage Temperature Range . . . . . -65°C to + 150°C  
 Max Voltage  $V_{IN}$  to Gnd. . . . . -0.5V to +6.5V  
 Max Voltage  $V_{OUT}$  to Gnd\*:  
 ISL60002,  $V_{OUT} = 1.25V$  . . . . . -0.5V to +2.25V  
 ISL60002,  $V_{OUT} = 2.50V$  . . . . . -0.5V to +3.50V  
 Voltage on “DNC” pins . . . . . No connections permitted to these pins.  
 Lead Temperature, Soldering\* . . . . . +225°C  
 \*Maximum duration = 10s

## Recommended Operating Conditions

Temperature Range (Industrial) . . . . . -40°C to 85°C

## ESD Ratings

MIL-STD-883, Method 3014 . . . . .  $\geq 5kV$

*CAUTION: Absolute Maximum Ratings are limits which may result in impaired reliability and/or permanent damage to the device. These are stress ratings provided for information only and functional operation of the device at these or any other conditions beyond those indicated in the operational sections of this specification are not implied.*

For guaranteed specifications and test conditions, see Electrical Specifications.

The guaranteed specifications apply only for the test conditions listed. Some performance characteristics may degrade when the device is not operated under the listed test conditions.

### Electrical Specifications ISL60002-10, $V_{OUT} = 1.024V$ (Additional specifications on page 7, “Common Electrical Specifications”) Operating Conditions: $V_{IN} = 3.0V$ , $I_{OUT} = 0mA$ , $C_{OUT} = 0.001\mu F$ , $T_A = -40$ to $+85^\circ C$ , unless otherwise specified.

SYMBOL	PARAMETER	CONDITIONS	MIN	TYP	MAX	UNITS
$V_{OUT}$	Output Voltage			1.024		V
$V_{OA}$	$V_{OUT}$ Accuracy	$T_A = 25^\circ C$				
		ISL60002B10	-1.0		+1.0	mV
		ISL60002C10	-2.5		+2.5	mV
		ISL60002D10	-5.0		+5.0	mV
$V_{IN}$	Input Voltage Range		2.7		5.5	V

### Electrical Specifications ISL60002-11, $V_{OUT} = 1.200V$ (Additional specifications on page 7, “Common Electrical Specifications”) Operating Conditions: $V_{IN} = 3.0V$ , $I_{OUT} = 0mA$ , $C_{OUT} = 0.001\mu F$ , $T_A = -40$ to $+85^\circ C$ , unless otherwise specified.

SYMBOL	PARAMETER	CONDITIONS	MIN	TYP	MAX	UNITS
$V_{OUT}$	Output Voltage			1.200		V
$V_{OA}$	$V_{OUT}$ Accuracy	$T_A = 25^\circ C$				
		ISL60002B11	-1.0		+1.0	mV
		ISL60002C11	-2.5		+2.5	mV
		ISL60002D11	-5.0		+5.0	mV
$V_{IN}$	Input Voltage Range		2.7		5.5	V

### Electrical Specifications ISL60002-12, $V_{OUT} = 1.250V$ (Additional specifications on page 7, “Common Electrical Specifications”) Operating Conditions: $V_{IN} = 3.0V$ , $I_{OUT} = 0mA$ , $C_{OUT} = 0.001\mu F$ , $T_A = -40$ to $+85^\circ C$ , unless otherwise specified.

SYMBOL	PARAMETER	CONDITIONS	MIN	TYP	MAX	UNITS
$V_{OUT}$	Output Voltage			1.250		V
$V_{OA}$	$V_{OUT}$ Accuracy	$T_A = 25^\circ C$				
		ISL60002B12	-1.0		+1.0	mV
		ISL60002C12	-2.5		+2.5	mV
		ISL60002D12	-5.0		+5.0	mV
$V_{IN}$	Input Voltage Range		2.7		5.5	V

## ISL60002

### Electrical Specifications ISL60002-18, $V_{OUT} = 1.800V$ (Additional specifications on page 7, "Common Electrical Specifications")

Operating Conditions:  $V_{IN} = 3.0V$ ,  $I_{OUT} = 0mA$ ,  $C_{OUT} = 0.001\mu F$ ,  $T_A = -40$  to  $+85^\circ C$ , unless otherwise specified.

SYMBOL	PARAMETER	CONDITIONS	MIN	TYP	MAX	UNITS
$V_{OUT}$	Output Voltage			1.800		V
$V_{OA}$	$V_{OUT}$ Accuracy	$T_A = 25^\circ C$				
		ISL60002B18	-1.0		+1.0	mV
		ISL60002C18	-2.5		+2.5	mV
		ISL60002D18	-5.0		+5.0	mV
$V_{IN}$	Input Voltage Range		2.7		5.5	V

### Electrical Specifications ISL60002-20, $V_{OUT} = 2.048V$ (Additional specifications on page 7, "Common Electrical Specifications")

Operating Conditions:  $V_{IN} = 3.0V$ ,  $I_{OUT} = 0mA$ ,  $C_{OUT} = 0.001\mu F$ ,  $T_A = -40$  to  $+85^\circ C$ , unless otherwise specified.

SYMBOL	PARAMETER	CONDITIONS	MIN	TYP	MAX	UNITS
$V_{OUT}$	Output Voltage			2.048		V
$V_{OA}$	$V_{OUT}$ Accuracy	$T_A = 25^\circ C$				
		ISL60002B20	-1.0		+1.0	mV
		ISL60002C20	-2.5		+2.5	mV
		ISL60002D20	-5.0		+5.0	mV
$V_{IN}$	Input Voltage Range		2.7		5.5	V

### Electrical Specifications ISL60002-25, $V_{OUT} = 2.500V$ (Additional specifications on page 7, "Common Electrical Specifications")

Operating Conditions:  $V_{IN} = 3.0V$ ,  $I_{OUT} = 0mA$ ,  $C_{OUT} = 0.001\mu F$ ,  $T_A = -40$  to  $+85^\circ C$ , unless otherwise specified.

SYMBOL	PARAMETER	CONDITIONS	MIN	TYP	MAX	UNITS
$V_{OUT}$	Output Voltage			2.500		V
$V_{OA}$	$V_{OUT}$ Accuracy	$T_A = 25^\circ C$				
		ISL60002B25	-1.0		+1.0	mV
		ISL60002C25	-2.5		+2.5	mV
		ISL60002D25	-5.0		+5.0	mV
$V_{IN}$	Input Voltage Range		2.7		5.5	V

### Electrical Specifications ISL60002-33, $V_{OUT} = 3.300V$

Operating Conditions:  $V_{IN} = 5.0V$ ,  $I_{OUT} = 0mA$ ,  $C_{OUT} = 0.001\mu F$ ,  $T_A = -40$  to  $+105^\circ C$ , unless otherwise specified.

SYMBOL	PARAMETER	CONDITIONS	MIN	TYP	MAX	UNITS
$V_{OUT}$	Output Voltage			3.300		V
$V_{OA}$	$V_{OUT}$ Accuracy	$T_A = 25^\circ C$				
		ISL60002B33	-1.0		1.0	mV
		ISL60002C33	-2.5		2.5	mV
		ISL60002D33	-5.0		5.0	mV
$TC V_{OUT}$	Output Voltage Temperature Coefficient (Note 1)				20	ppm/ $^\circ C$
$V_{IN}$	Input Voltage Range		3.5		5.5	V
$I_{IN}$	Supply Current			350	700	nA
$\Delta V_{OUT}/\Delta V_{IN}$	Line Regulation	$+3.5V \leq V_{IN} \leq +5.5V$		80	200	$\mu V/V$
$\Delta V_{OUT}/\Delta I_{OUT}$	Load Regulation	$0mA \leq I_{SOURCE} \leq 20mA$		25	100	$\mu V/mA$
		$-20mA \leq I_{SINK} \leq 0mA$		50	150	$\mu V/mA$

## ISL60002

### Electrical Specifications ISL60002-33, $V_{OUT} = 3.300V$ (Continued)

Operating Conditions:  $V_{IN} = 5.0V$ ,  $I_{OUT} = 0mA$ ,  $C_{OUT} = 0.001\mu F$ ,  $T_A = -40$  to  $+105^\circ C$ , unless otherwise specified.

SYMBOL	PARAMETER	CONDITIONS	MIN	TYP	MAX	UNITS
$\Delta V_{OUT}/\Delta t$	Long Term Stability (Note 4)	$T_A = 25^\circ C$		10		ppm/ $\sqrt{1}$ kHrs
$\Delta V_{OUT}/\Delta T_A$	Thermal Hysteresis (Note 2)	$\Delta T_A = 145^\circ C$		100		ppm
$I_{SC}$	Short Circuit Current (Note 3)	$T_A = 25^\circ C$		50	80	mA
$V_N$	Output Voltage Noise	$0.1Hz \leq f \leq 10Hz$		30		$\mu V_{P-P}$

### Common Electrical Specifications ISL60002-10, -11, -12, -18, -20, and -25

Operating Conditions:  $V_{IN} = 3.0V$ ,  $I_{OUT} = 0mA$ ,  $C_{OUT} = 0.001\mu F$ ,  $T_A = -40$  to  $+85^\circ C$ , unless otherwise specified

SYMBOL	PARAMETER	CONDITIONS	MIN	TYP	MAX	UNITS
$TC V_{OUT}$	Output Voltage Temperature Coefficient (Note 1)				20	ppm/ $^\circ C$
$I_{IN}$	Supply Current			350	700	nA
$\Delta V_{OUT}/\Delta V_{IN}$	Line Regulation	$+2.7V \leq V_{IN} \leq +5.5V$		80	200	$\mu V/V$
$\Delta V_{OUT}/\Delta I_{OUT}$	Load Regulation	$0mA \leq I_{SOURCE} \leq 7mA$		25	100	$\mu V/mA$
		$-7mA \leq I_{SINK} \leq 0mA$		50	150	$\mu V/mA$
$\Delta V_{OUT}/\Delta t$	Long Term Stability (Note 4)	$T_A = 25^\circ C$		10		ppm/ $\sqrt{1}$ kHrs
$\Delta V_{OUT}/\Delta T_A$	Thermal Hysteresis (Note 2)	$\Delta T_A = 125^\circ C$		100		ppm
$I_{SC}$	Short Circuit Current (Note 3)	$T_A = 25^\circ C$		50	80	mA
$V_N$	Output Voltage Noise	$0.1Hz \leq f \leq 10Hz$		30		$\mu V_{P-P}$

#### NOTES:

- Over the specified temperature range. Temperature coefficient is measured by the box method whereby the change in  $V_{OUT}$  is divided by the temperature range: ( $-40^\circ C$  to  $+85^\circ C = 125^\circ C$ , or  $-40^\circ C$  to  $+105^\circ C = 145^\circ C$  for the ISL60002-33).
- Thermal Hysteresis is the change in  $V_{OUT}$  measured @  $T_A = 25^\circ C$  after temperature cycling over a specified range,  $\Delta T_A$ .  $V_{OUT}$  is read initially at  $T_A = 25^\circ C$  for the device under test. The device is temperature cycled and a second  $V_{OUT}$  measurement is taken at  $25^\circ C$ . The difference between the initial  $V_{OUT}$  reading and the second  $V_{OUT}$  reading is then expressed in ppm. For  $\Delta T_A = 125^\circ C$ , the device under is cycled from  $+25^\circ C$  to  $+85^\circ C$  to  $-40^\circ C$  to  $+25^\circ C$ , and for  $\Delta T_A = 145^\circ C$ , the device under is cycled from  $+25^\circ C$  to  $+105^\circ C$  to  $-40^\circ C$  to  $+25^\circ C$ .
- Guaranteed by device characterization and/or correlation to other device tests.
- FGA™ voltage reference long term drift is a logarithmic characteristic. Changes that occur after the first few hundred hours of operation are significantly smaller with time, asymptotically approaching zero beyond 2000 hours. Because of this decreasing characteristic, long-term drift is specified in ppm/ $\sqrt{1}$ kHr.

**Typical Performance Characteristic Curves ISL60002,  $V_{OUT} = 1.024V$**

$V_{IN} = 3.0V$ ,  $I_{OUT} = 0mA$ ,  $T_A = 25^{\circ}C$  unless otherwise specified

*To Be Added in Q1-06*

*To Be Added in Q1-06*

FIGURE 1.

FIGURE 2.

*To Be Added in Q1-06*

*To Be Added in Q1-06*

FIGURE 3.

FIGURE 4.

*To Be Added in Q1-06*

*To Be Added in Q1-06*

FIGURE 5.

FIGURE 6.



**Typical Performance Characteristic Curves ISL60002,  $V_{OUT} = 1.024V$**  (Continued)

$V_{IN} = 3.0V$ ,  $I_{OUT} = 0mA$ ,  $T_A = 25^{\circ}C$  unless otherwise specified

*To Be Added in Q1-06*

*To Be Added in Q1-06*

FIGURE 7.

FIGURE 8.

*To Be Added in Q1-06*

*To Be Added in Q1-06*

FIGURE 9.

FIGURE 10.

*To Be Added in Q1-06*

*To Be Added in Q1-06*

FIGURE 11.

FIGURE 12.

**Typical Performance Characteristic Curves ISL60002,  $V_{OUT} = 1.024V$**  (Continued)

$V_{IN} = 3.0V$ ,  $I_{OUT} = 0mA$ ,  $T_A = 25^{\circ}C$  unless otherwise specified

To Be Added in Q1-06

To Be Added in Q1-06

FIGURE 13.

FIGURE 14.

**Typical Performance Characteristic Curves ISL60002,  $V_{OUT} = 1.20V$**

$V_{IN} = 3.0V$ ,  $I_{OUT} = 0mA$ ,  $T_A = 25^{\circ}C$  unless otherwise specified

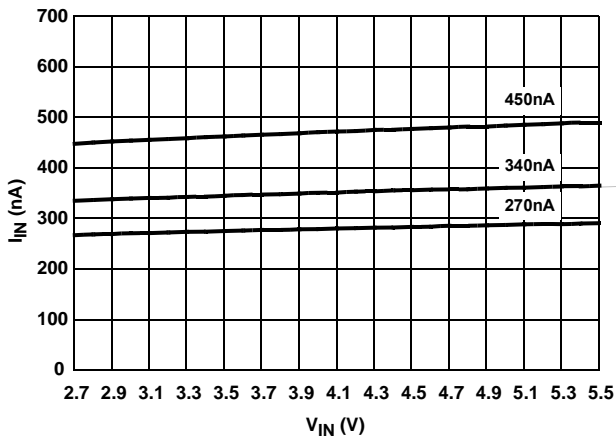

FIGURE 15.  $I_{IN}$  vs  $V_{IN}$  (3 REPRESENTATIVE UNITS)

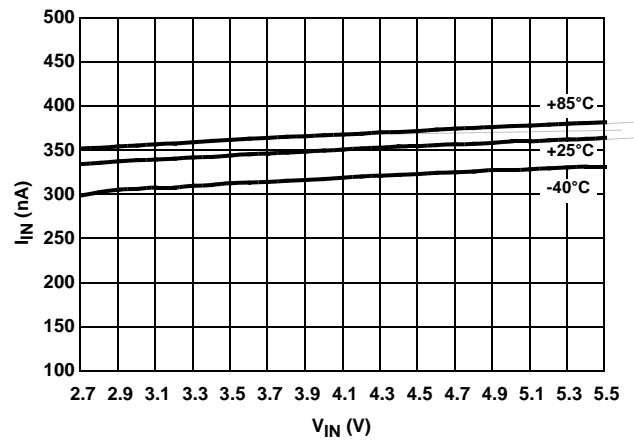

FIGURE 16.  $I_{IN}$  vs  $V_{IN}$  OVER TEMPERATURE

**Typical Performance Characteristic Curves ISL60002,  $V_{OUT} = 1.20V$**  (Continued)

$V_{IN} = 3.0V$ ,  $I_{OUT} = 0mA$ ,  $T_A = 25^{\circ}C$  unless otherwise specified

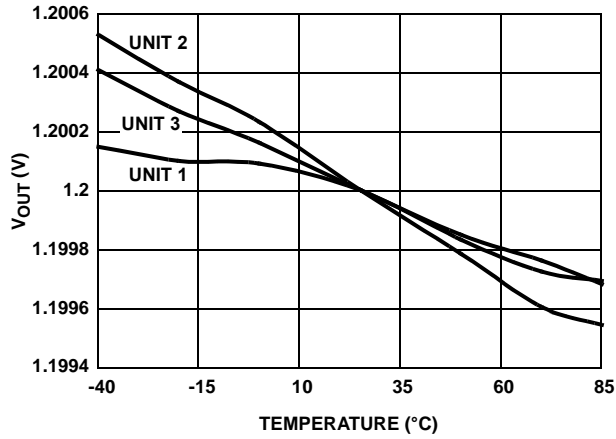

FIGURE 17.  $V_{OUT}$  vs TEMPERATURE NORMALIZED to  $25^{\circ}C$

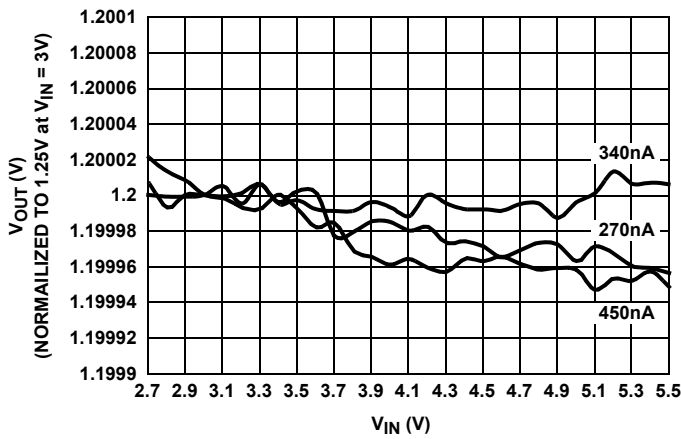

FIGURE 18. LINE REGULATION (3 REPRESENTATIVE UNITS)

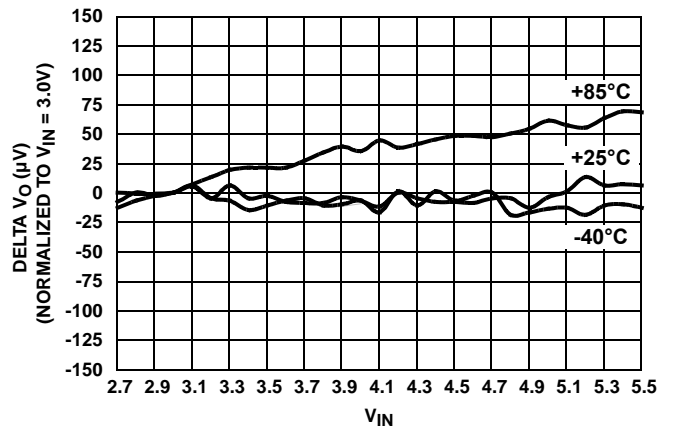

FIGURE 19. LINE REGULATION OVER TEMPERATURE

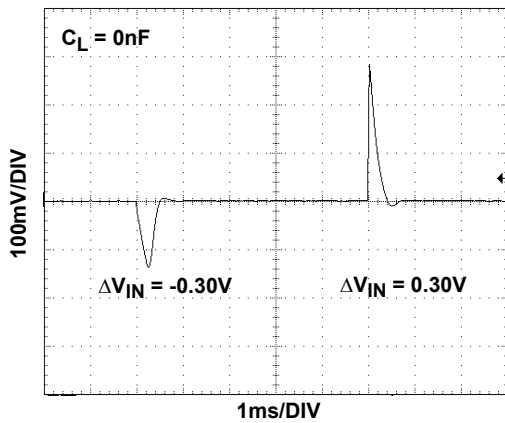

FIGURE 20. LINE TRANSIENT RESPONSE

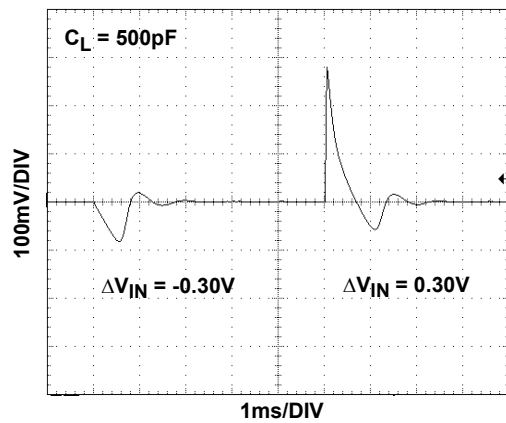

FIGURE 21. LINE TRANSIENT RESPONSE

Typical Performance Characteristic Curves ISL60002,  $V_{OUT} = 1.20V$  (Continued)

$V_{IN} = 3.0V$ ,  $I_{OUT} = 0mA$ ,  $T_A = 25^\circ C$  unless otherwise specified

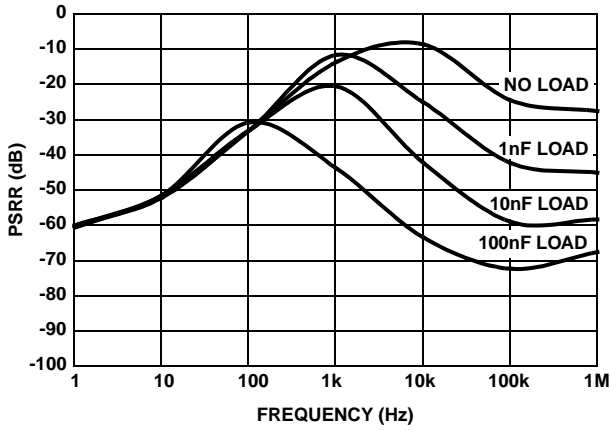

FIGURE 22. PSRR vs CAPACITIVE LOAD

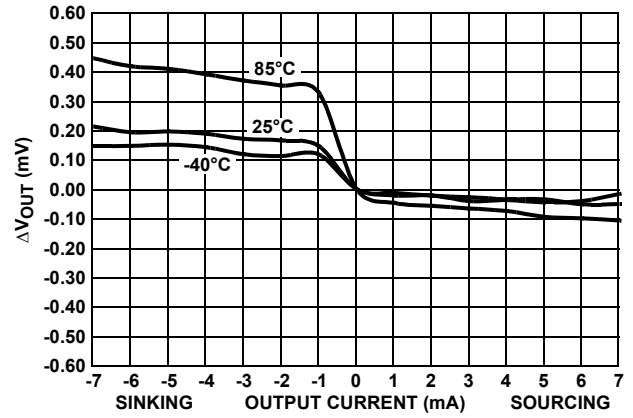

FIGURE 23. LOAD REGULATION

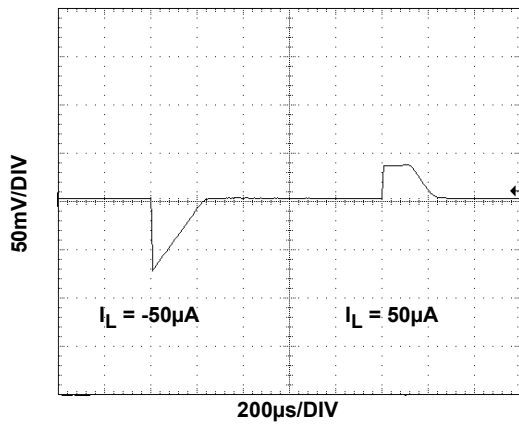

FIGURE 24. LOAD TRANSIENT RESPONSE

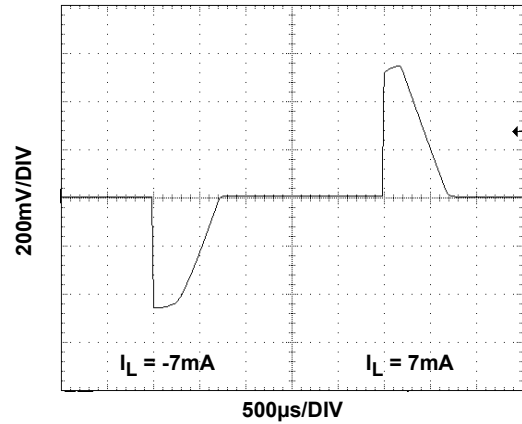

FIGURE 25. LOAD TRANSIENT RESPONSE

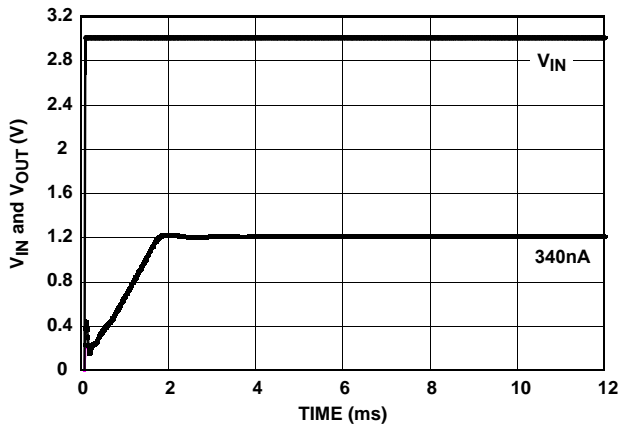

FIGURE 26. TURN-ON TIME (25°C)

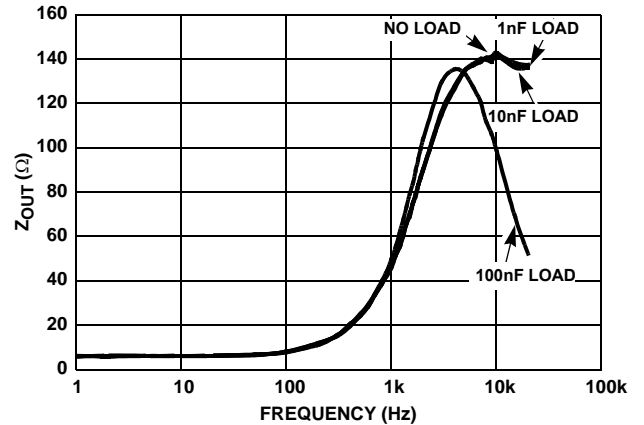

FIGURE 27.  $Z_{OUT}$  vs FREQUENCY

**Typical Performance Characteristic Curves ISL60002,  $V_{OUT} = 1.20V$**  (Continued)

$V_{IN} = 3.0V$ ,  $I_{OUT} = 0mA$ ,  $T_A = 25^{\circ}C$  unless otherwise specified

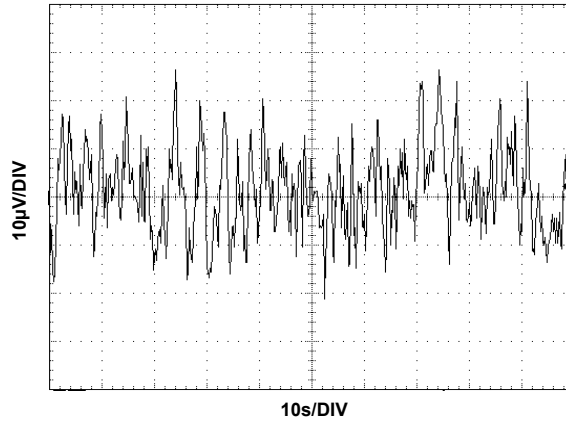

FIGURE 28.  $V_{OUT}$  NOISE

**Typical Performance Characteristic Curves ISL60002,  $V_{OUT} = 1.25V$**

$V_{IN} = 3.0V$ ,  $I_{OUT} = 0mA$ ,  $T_A = 25^{\circ}C$  unless otherwise specified

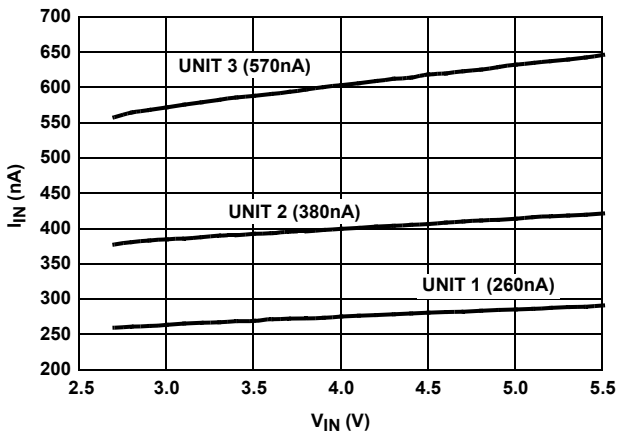

FIGURE 29.  $I_{IN}$  vs  $V_{IN}$  (3 REPRESENTATIVE UNITS)

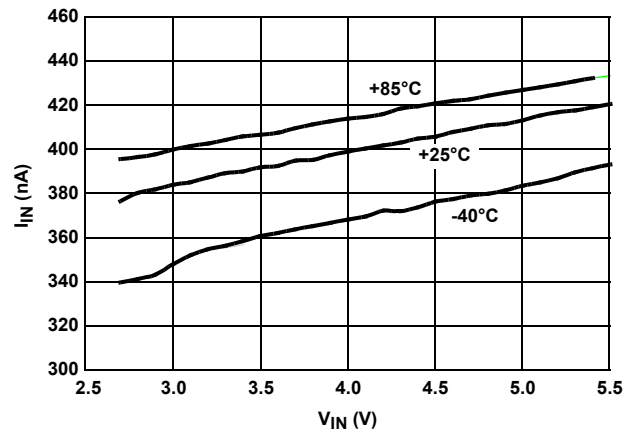

FIGURE 30.  $I_{IN}$  vs  $V_{IN}$  OVER TEMPERATURE

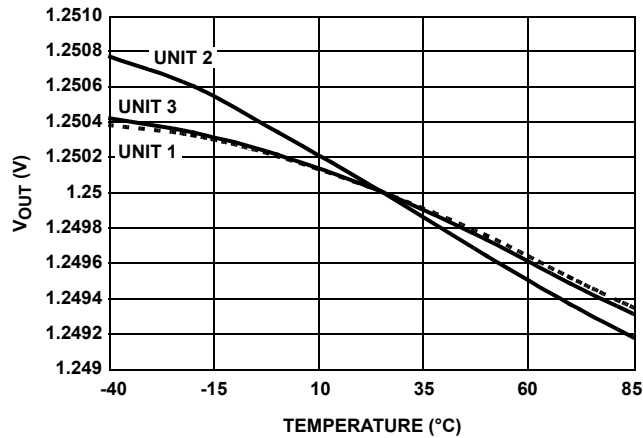

FIGURE 31.  $V_{OUT}$  vs TEMPERATURE NORMALIZED TO  $25^{\circ}C$

**Typical Performance Characteristic Curves ISL60002,  $V_{OUT} = 1.25V$**  (Continued)

$V_{IN} = 3.0V$ ,  $I_{OUT} = 0mA$ ,  $T_A = 25^\circ C$  unless otherwise specified

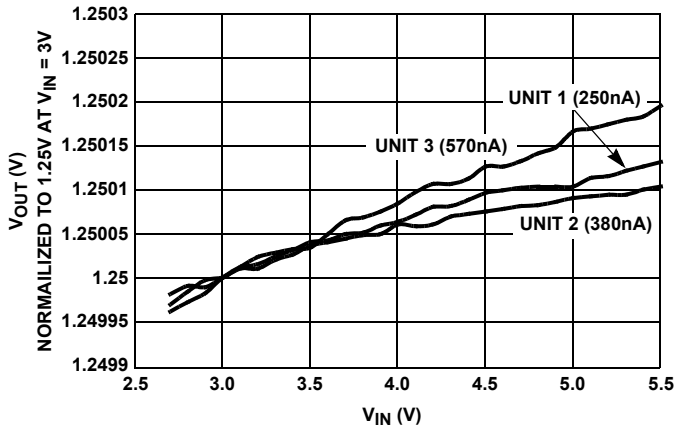

FIGURE 32. LINE REGULATION (3 REPRESENTATIVE UNITS)

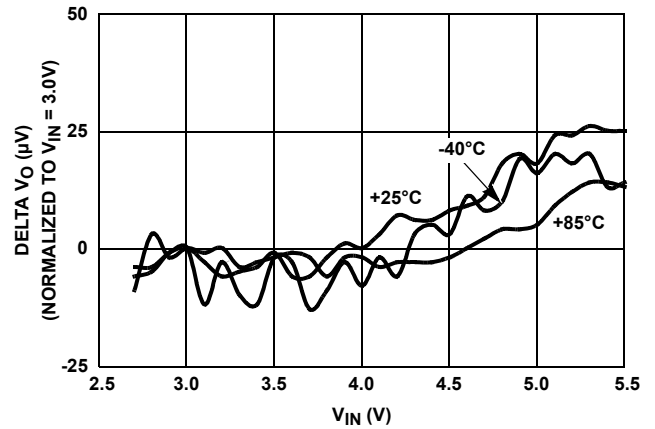

FIGURE 33. LINE REGULATION OVER TEMPERATURE

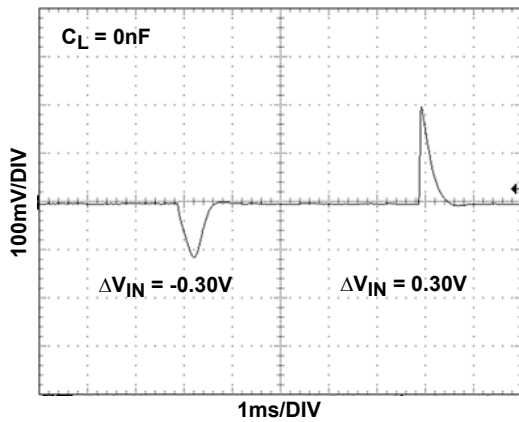

FIGURE 34. LINE TRANSIENT RESPONSE

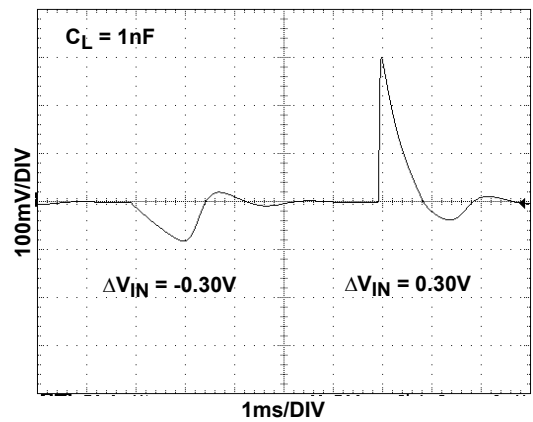

FIGURE 35. LINE TRANSIENT RESPONSE

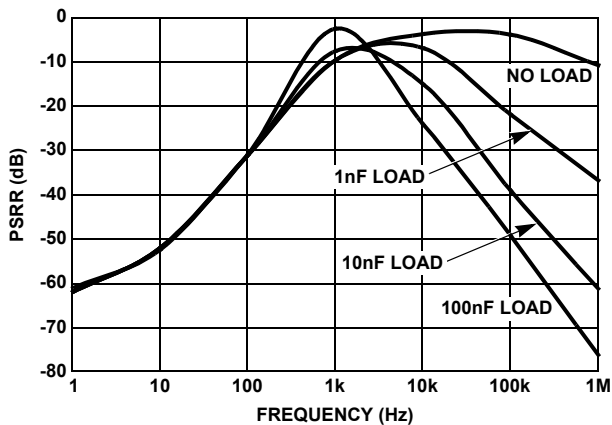

FIGURE 36. PSRR vs CAPACITIVE LOAD

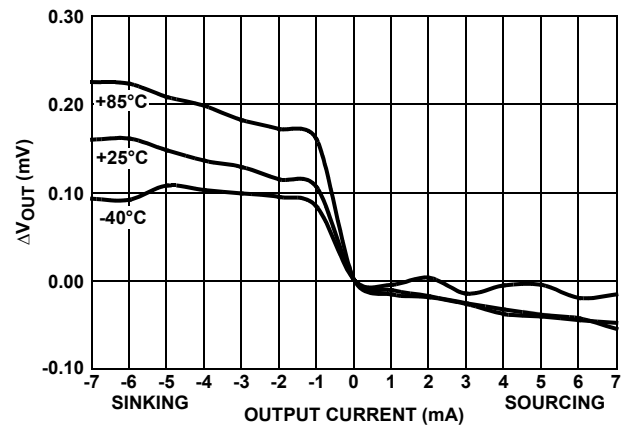

FIGURE 37. LOAD REGULATION

**Typical Performance Characteristic Curves ISL60002,  $V_{OUT} = 1.25V$**  (Continued)

$V_{IN} = 3.0V$ ,  $I_{OUT} = 0mA$ ,  $T_A = 25^\circ C$  unless otherwise specified

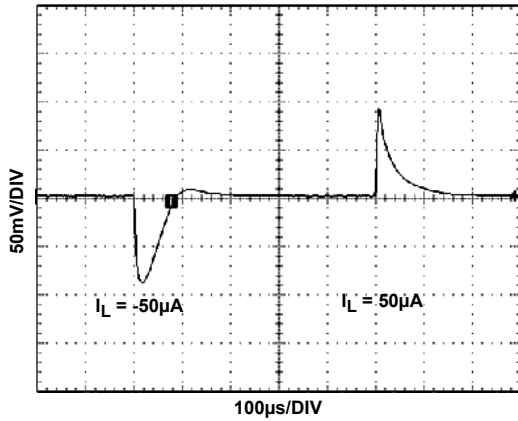

FIGURE 38. LOAD TRANSIENT RESPONSE

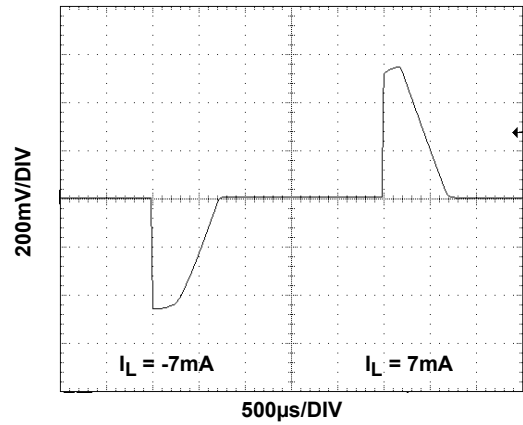

FIGURE 39. LOAD TRANSIENT RESPONSE

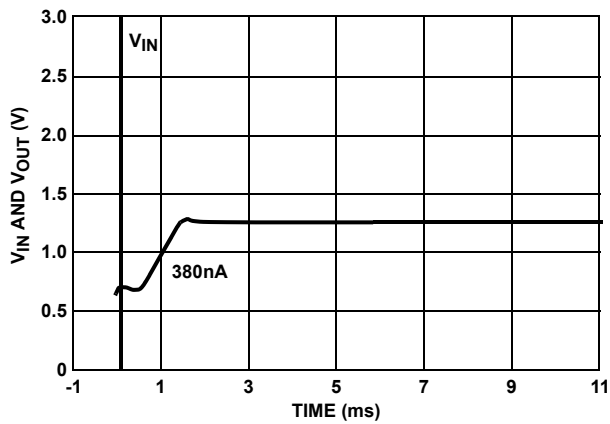

FIGURE 40. TURN-ON TIME ( $25^\circ C$ )

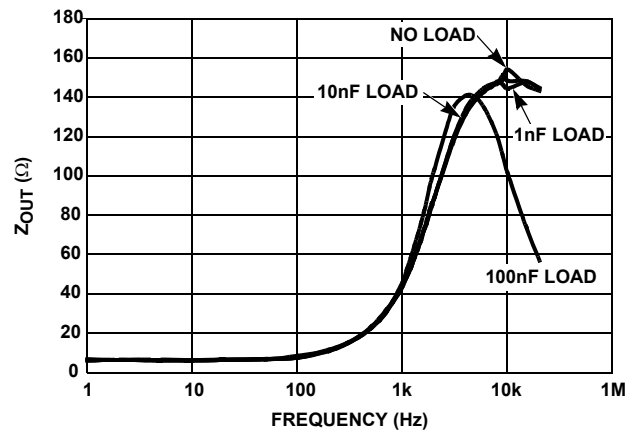

FIGURE 41.  $Z_{OUT}$  vs FREQUENCY

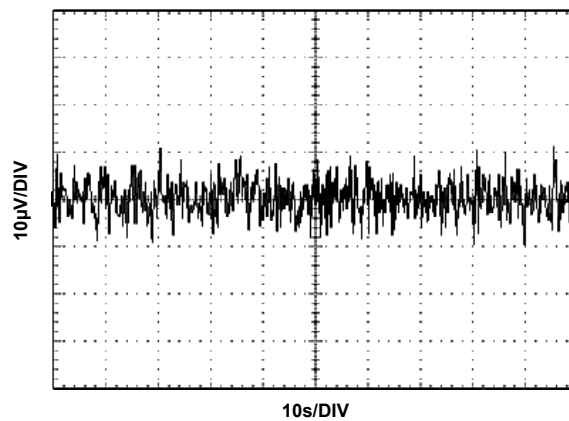

FIGURE 42.  $V_{OUT}$  NOISE

**Typical Performance Characteristic Curves ISL60002,  $V_{OUT} = 1.8V$**

$V_{IN} = 3.0V$ ,  $I_{OUT} = 0mA$ ,  $T_A = 25^{\circ}C$  unless otherwise specified

*To Be Added in Q1-06*

*To Be Added in Q1-06*

FIGURE 43.

FIGURE 44.

*To Be Added in Q1-06*

*To Be Added in Q1-06*

FIGURE 45.

FIGURE 46.

*To Be Added in Q1-06*

*To Be Added in Q1-06*

FIGURE 47.

FIGURE 48.



**Typical Performance Characteristic Curves ISL60002,  $V_{OUT} = 1.8V$**  (Continued)

$V_{IN} = 3.0V$ ,  $I_{OUT} = 0mA$ ,  $T_A = 25^{\circ}C$  unless otherwise specified

*To Be Added in Q1-06*

*To Be Added in Q1-06*

FIGURE 49.

FIGURE 50.

*To Be Added in Q1-06*

*To Be Added in Q1-06*

FIGURE 51.

FIGURE 52.

*To Be Added in Q1-06*

*To Be Added in Q1-06*

FIGURE 53.

FIGURE 54.

**Typical Performance Characteristic Curves ISL60002,  $V_{OUT} = 1.8V$**  (Continued)

$V_{IN} = 3.0V$ ,  $I_{OUT} = 0mA$ ,  $T_A = 25^{\circ}C$  unless otherwise specified

*To Be Added in Q1-06*

*To Be Added in Q1-06*

FIGURE 55.

FIGURE 56.

**Typical Performance Characteristic Curves ISL60002,  $V_{OUT} = 2.048V$**

$V_{IN} = 3.0V$ ,  $I_{OUT} = 0mA$ ,  $T_A = 25^{\circ}C$  unless otherwise specified

*To Be Added in Q1-06*

*To Be Added in Q1-06*

FIGURE 57.

FIGURE 58.

**Typical Performance Characteristic Curves ISL60002,  $V_{OUT} = 2.048V$**  (Continued)

$V_{IN} = 3.0V$ ,  $I_{OUT} = 0mA$ ,  $T_A = 25^{\circ}C$  unless otherwise specified

*To Be Added in Q1-06*

*To Be Added in Q1-06*

FIGURE 59.

FIGURE 60.

*To Be Added in Q1-06*

*To Be Added in Q1-06*

FIGURE 61.

FIGURE 62.

*To Be Added in Q1-06*

*To Be Added in Q1-06*

FIGURE 63.

FIGURE 64.

**Typical Performance Characteristic Curves ISL60002,  $V_{OUT} = 2.048V$**  (Continued)

$V_{IN} = 3.0V$ ,  $I_{OUT} = 0mA$ ,  $T_A = 25^{\circ}C$  unless otherwise specified

*To Be Added in Q1-06*

*To Be Added in Q1-06*

FIGURE 65.

FIGURE 66.

*To Be Added in Q1-06*

*To Be Added in Q1-06*

FIGURE 67.

FIGURE 68.

*To Be Added in Q1-06*

*To Be Added in Q1-06*

FIGURE 69.

FIGURE 70.

**Typical Performance Characteristic Curves ISL60002,  $V_{OUT} = 2.50V$**

$V_{IN} = 3.0V$ ,  $I_{OUT} = 0mA$ ,  $T_A = 25^\circ C$  unless otherwise specified

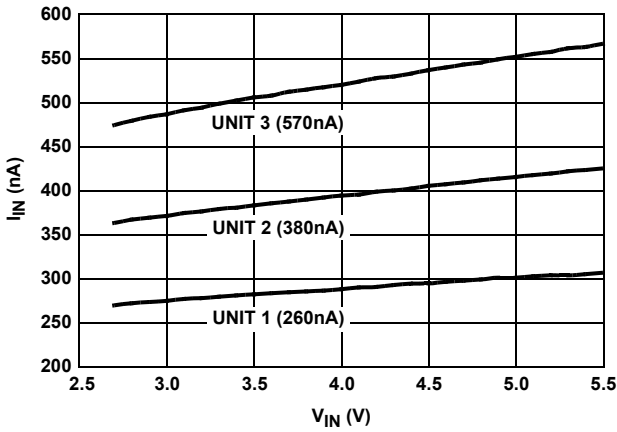

FIGURE 71.  $I_{IN}$  vs  $V_{IN}$  (3 REPRESENTATIVE UNITS)

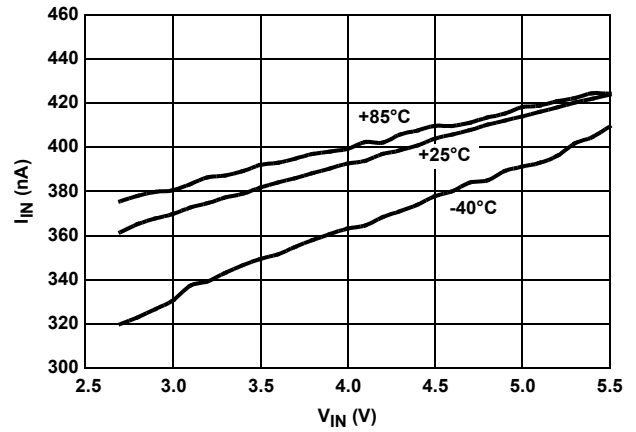

FIGURE 72.  $I_{IN}$  vs  $V_{IN}$  OVER TEMPERATURE

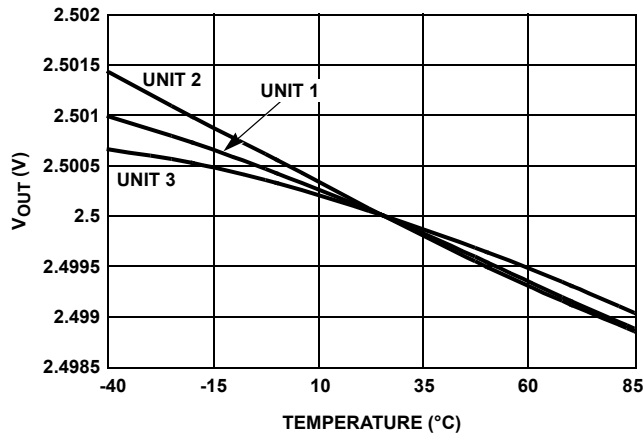

FIGURE 73.  $V_{OUT}$  vs TEMPERATURE NORMALIZED TO  $25^\circ C$

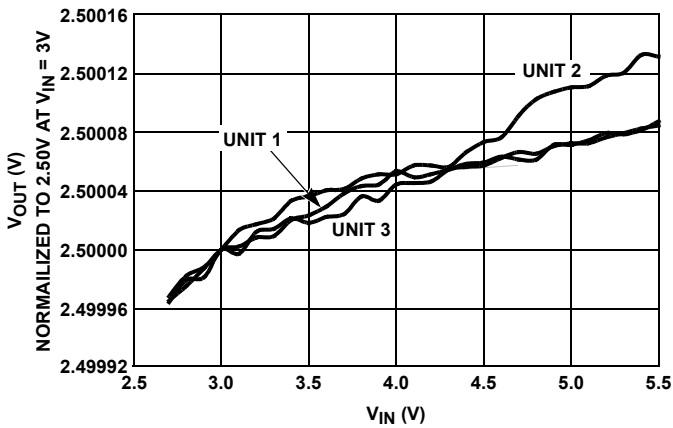

FIGURE 74. LINE REGULATION (3 REPRESENTATIVE UNITS)

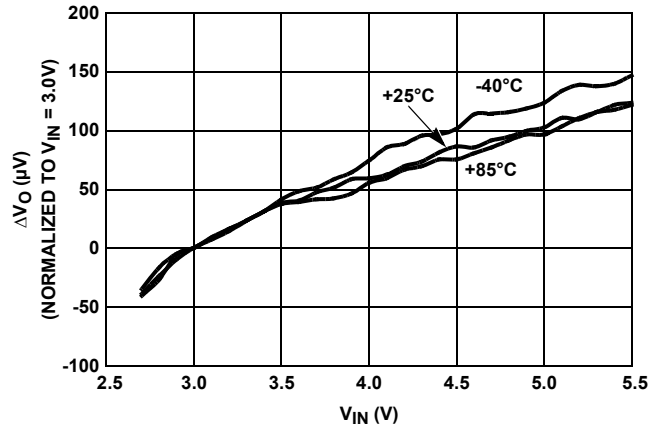

FIGURE 75. LINE REGULATION OVER TEMPERATURE

**Typical Performance Characteristic Curves ISL60002,  $V_{OUT} = 2.50V$**  (Continued)

$V_{IN} = 3.0V$ ,  $I_{OUT} = 0mA$ ,  $T_A = 25^\circ C$  unless otherwise specified

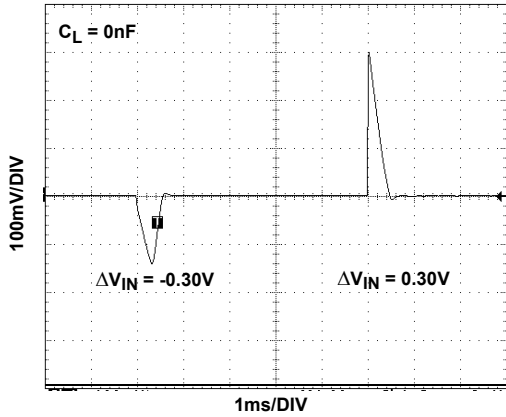

FIGURE 76. LINE TRANSIENT RESPONSE

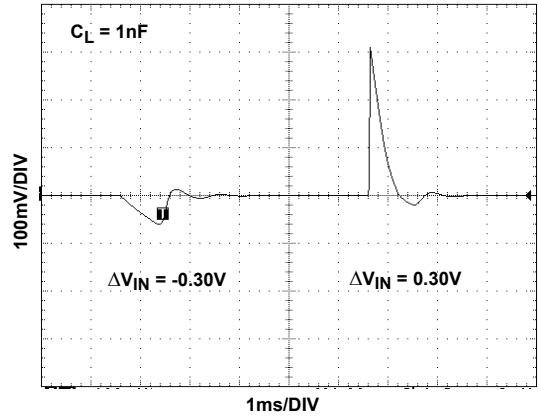

FIGURE 77. LINE TRANSIENT RESPONSE

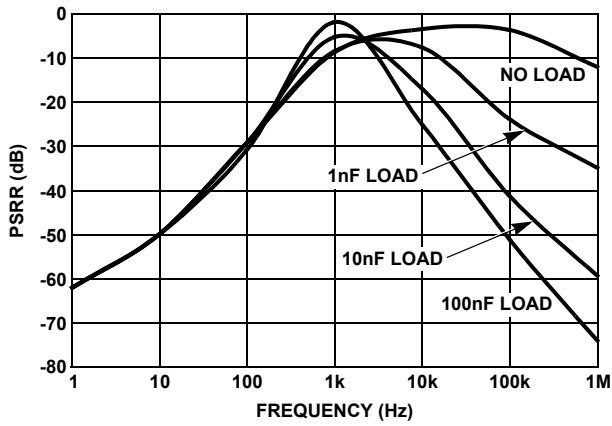

FIGURE 78. PSRR vs CAPACITIVE LOAD

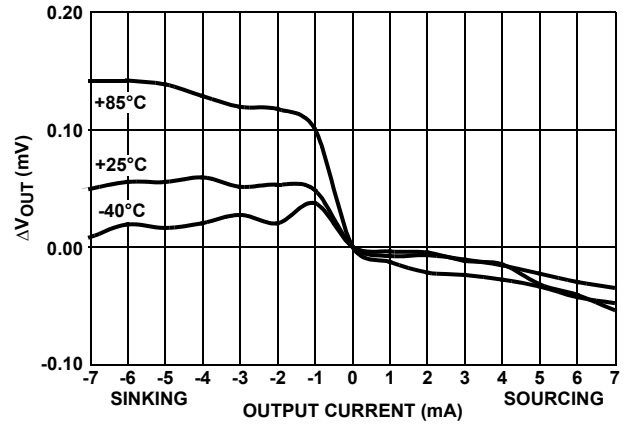

FIGURE 79. LOAD REGULATION

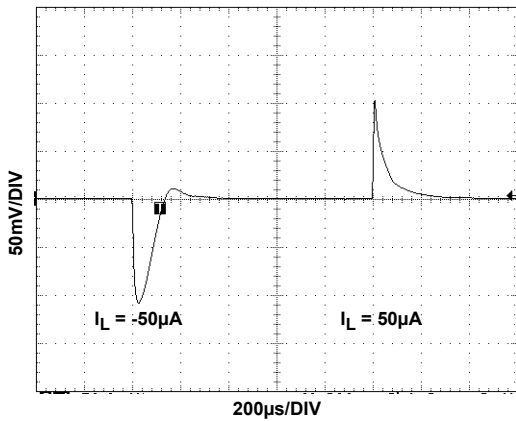

FIGURE 80. LOAD TRANSIENT RESPONSE

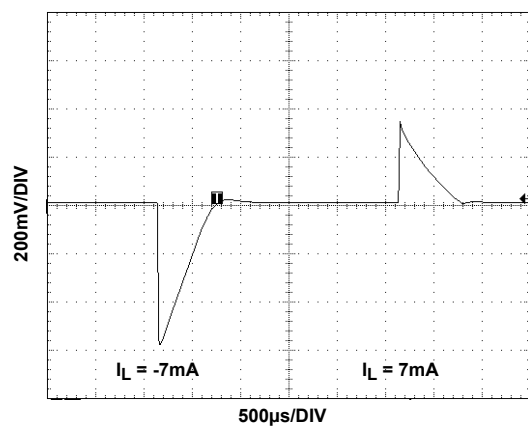

FIGURE 81. LOAD TRANSIENT RESPONSE

**Typical Performance Characteristic Curves ISL60002,  $V_{OUT} = 2.50V$**  (Continued)

$V_{IN} = 3.0V$ ,  $I_{OUT} = 0mA$ ,  $T_A = 25^\circ C$  unless otherwise specified

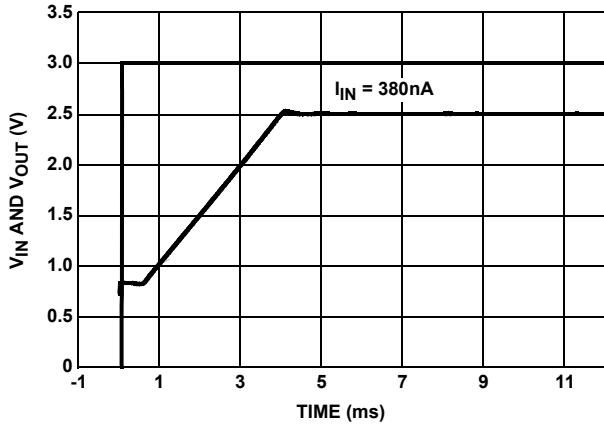

FIGURE 82. TURN-ON TIME (25°C)

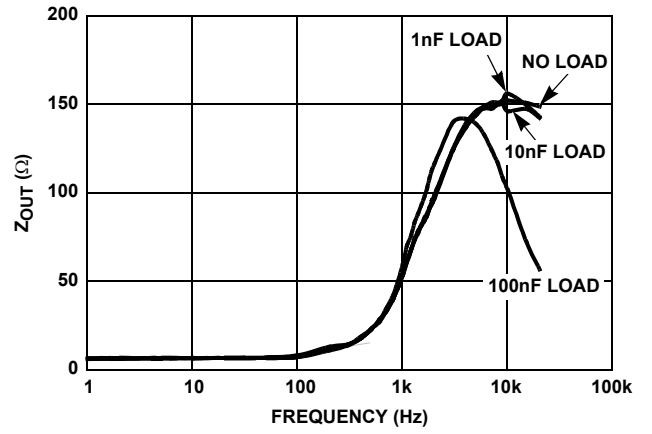

FIGURE 83.  $Z_{OUT}$  vs FREQUENCY

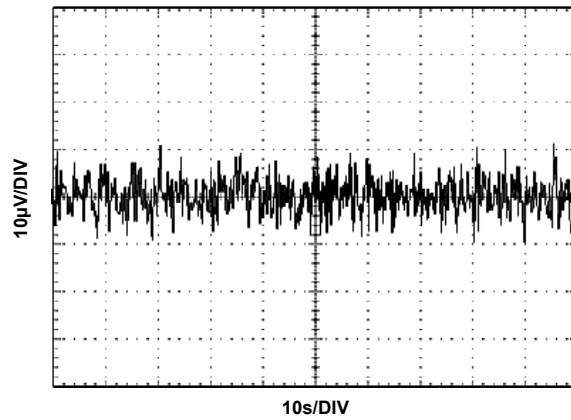

FIGURE 84.  $V_{OUT}$  NOISE

**Typical Performance Characteristic Curves ISL60002,  $V_{OUT} = 3.3V$**

$V_{IN} = 3.0V$ ,  $I_{OUT} = 0mA$ ,  $T_A = 25^\circ C$  unless otherwise specified

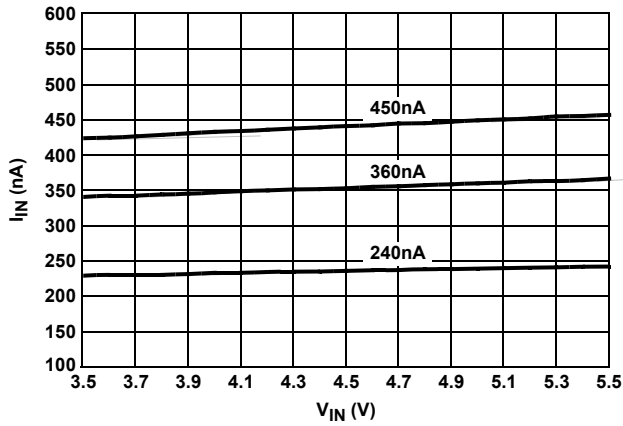

FIGURE 85.  $I_{IN}$  vs  $V_{IN}$  (3 REPRESENTATIVE UNITS)

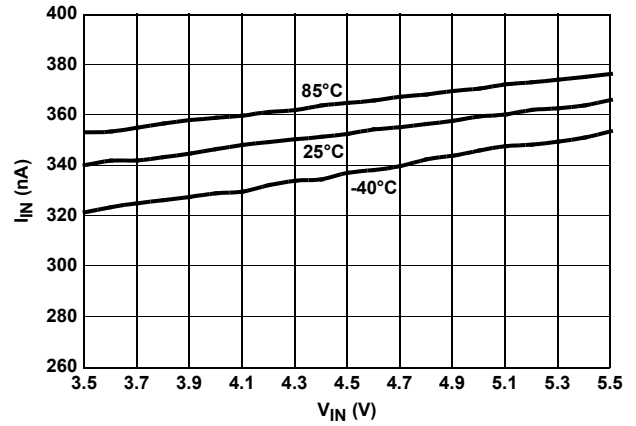

FIGURE 86.  $I_{IN}$  vs  $V_{IN}$  OVER TEMPERATURE

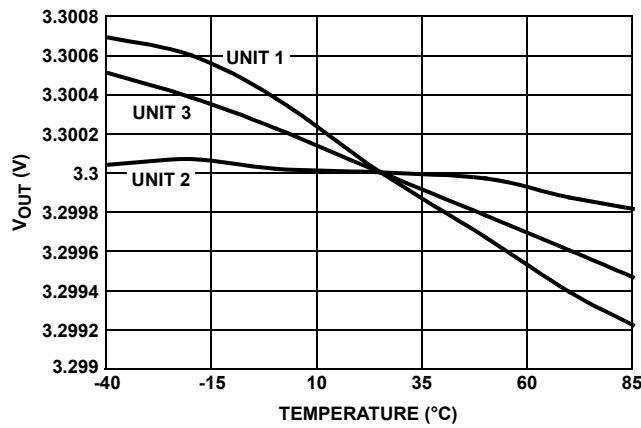

FIGURE 87.  $V_{OUT}$  vs TEMPERATURE NORMALIZED TO  $25^\circ C$

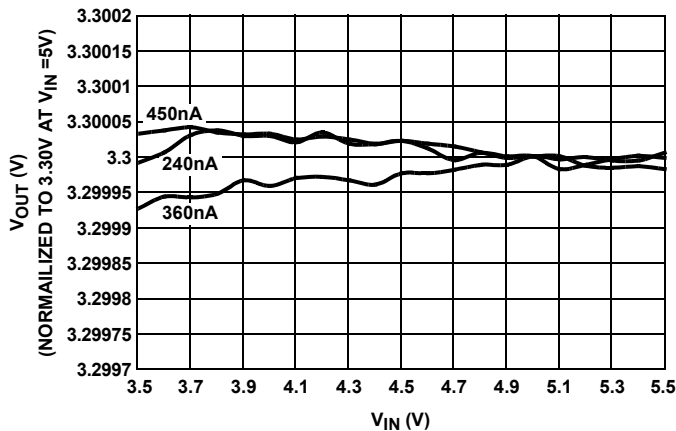

FIGURE 88. LINE REGULATION (3 REPRESENTATIVE UNITS)

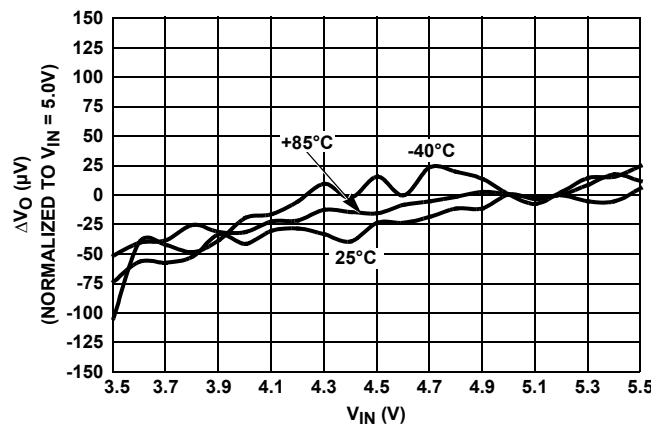

FIGURE 89. LINE REGULATION OVER TEMPERATURE



**Typical Performance Characteristic Curves ISL60002,  $V_{OUT} = 3.3V$**  (Continued)

$V_{IN} = 3.0V$ ,  $I_{OUT} = 0mA$ ,  $T_A = 25^\circ C$  unless otherwise specified

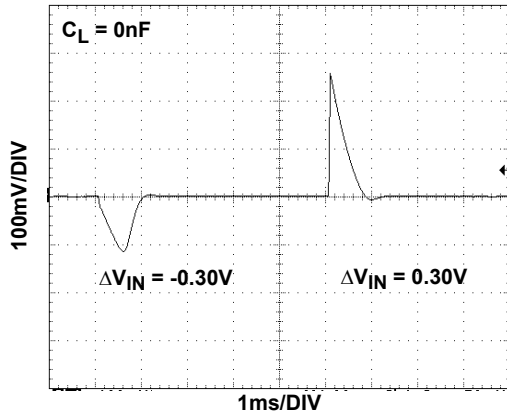

FIGURE 90. LINE TRANSIENT RESPONSE

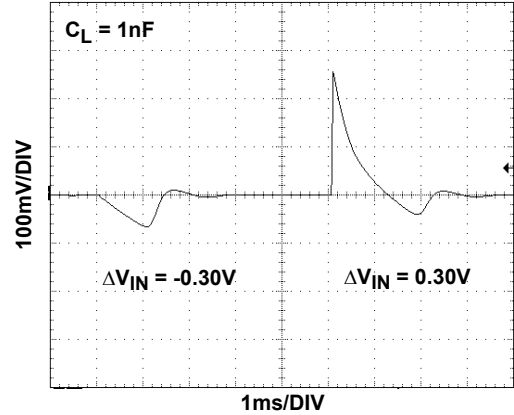

FIGURE 91. LINE TRANSIENT RESPONSE

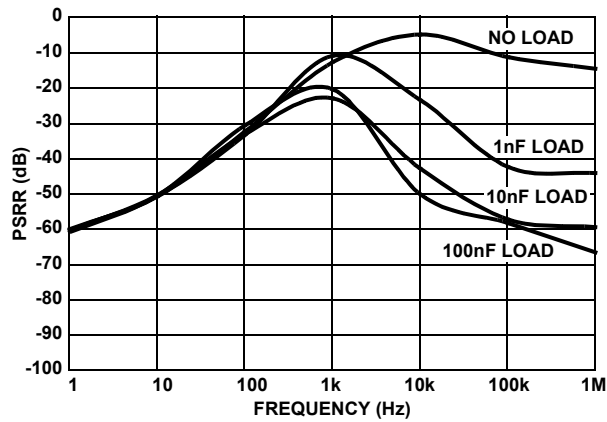

FIGURE 92. PSRR vs CAPACITIVE LOAD

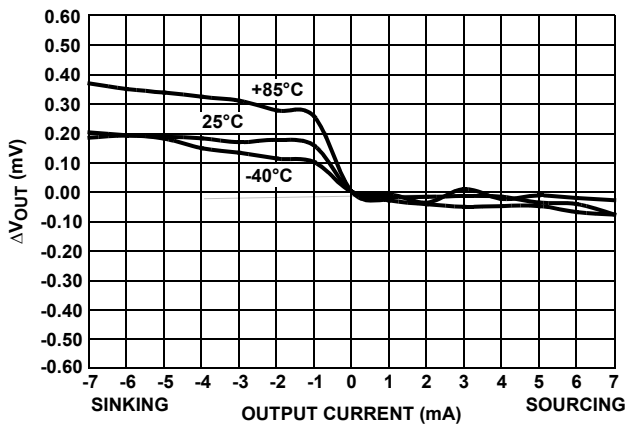

FIGURE 93. LOAD REGULATION  $I_{SOURCE} - I_{SINK} = \pm 7mA$

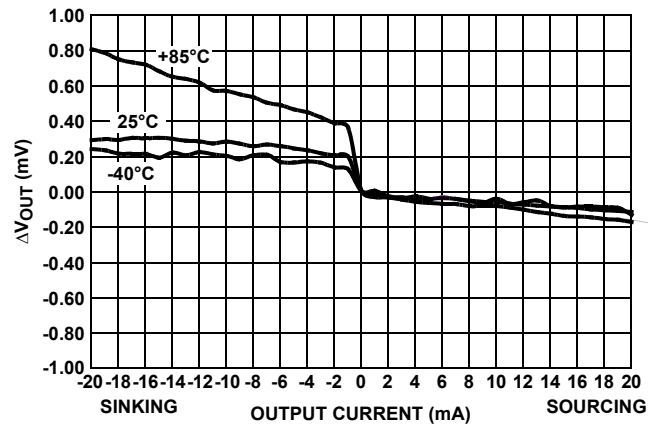

FIGURE 94. LOAD REGULATION  $I_{SOURCE} - I_{SINK} = \pm 20mA$

**Typical Performance Characteristic Curves ISL60002,  $V_{OUT} = 3.3V$**  (Continued)

$V_{IN} = 3.0V$ ,  $I_{OUT} = 0mA$ ,  $T_A = 25^\circ C$  unless otherwise specified

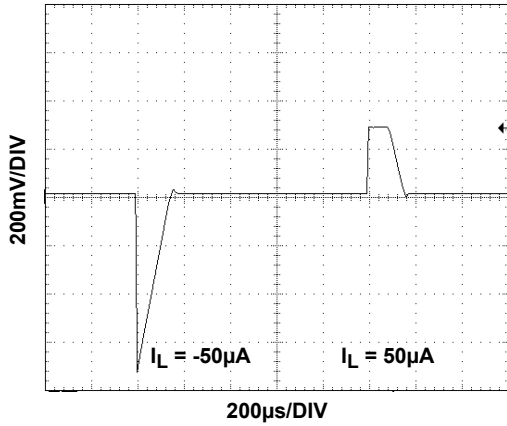

FIGURE 95. LOAD TRANSIENT RESPONSE

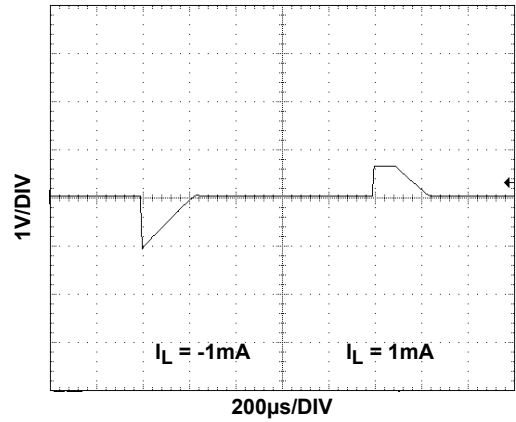

FIGURE 96. LOAD TRANSIENT RESPONSE

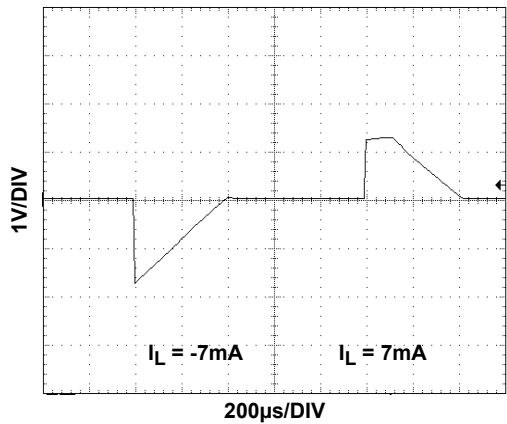

FIGURE 97. LOAD TRANSIENT RESPONSE

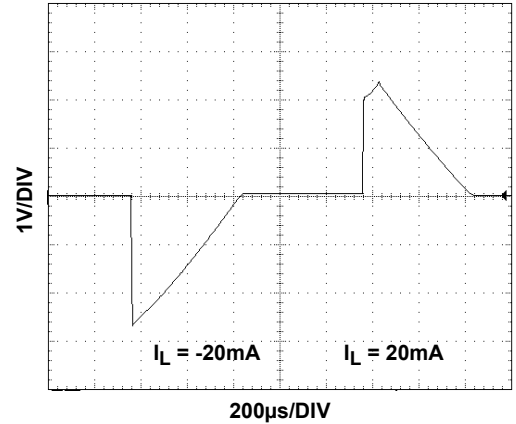

FIGURE 98. LOAD TRANSIENT RESPONSE

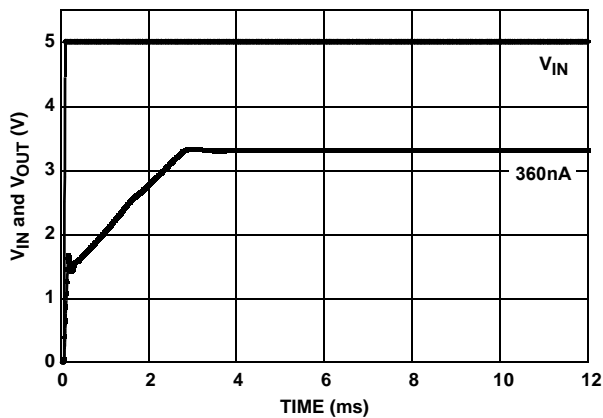

FIGURE 99. TURN-ON TIME ( $25^\circ C$ )

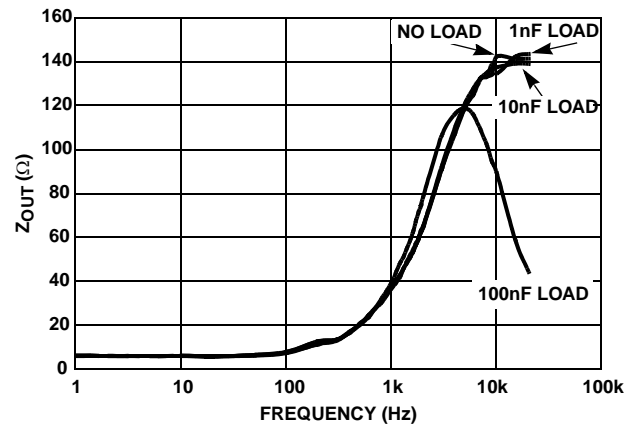

FIGURE 100.  $Z_{OUT}$  vs. FREQUENCY

## Applications Information

### FGA Technology

The ISL60002 series of voltage references use the floating gate technology to create references with very low drift and supply current. Essentially the charge stored on a floating gate cell is set precisely in manufacturing. The reference voltage output itself is a buffered version of the floating gate voltage. The resulting reference device has excellent characteristics which are unique in the industry: very low temperature drift, high initial accuracy, and almost zero supply current. Also, the reference voltage itself is not limited by voltage bandgaps or zener settings, so a wide range of reference voltages can be programmed (standard voltage settings are provided, but customer-specific voltages are available).

The process used for these reference devices is a floating gate CMOS process, and the amplifier circuitry uses CMOS transistors for amplifier and output transistor circuitry. While providing excellent accuracy, there are limitations in output noise level and load regulation due to the MOS device characteristics. These limitations are addressed with circuit techniques discussed in other sections.

### Nanopower Operation

Reference devices achieve their highest accuracy when powered up continuously, and after initial stabilization has taken place. This drift can be eliminated by leaving the power on continuously.

The ISL60002 is the first high precision voltage reference with ultra low power consumption that makes it possible to leave power on continuously in battery operated circuits. The ISL60002 consumes extremely low supply current due to the proprietary FGA technology. Supply current at room temperature is typically 350nA which is 1 to 2 orders of magnitude lower than competitive devices. Application circuits using battery power will benefit greatly from having an accurate, stable reference which essentially presents no load to the battery.

In particular, battery powered data converter circuits that would normally require the entire circuit to be disabled when not in use can remain powered up between conversions as shown in Figure 101. Data acquisition circuits providing 12 to 24 bits of accuracy can operate with the reference device continuously biased with no power penalty, providing the highest accuracy and lowest possible long term drift.

Other reference devices consuming higher supply currents will need to be disabled in between conversions to conserve battery capacity. Absolute accuracy will suffer as the device is biased and requires time to settle to its final value, or, may not actually settle to a final value as power on time may be short.

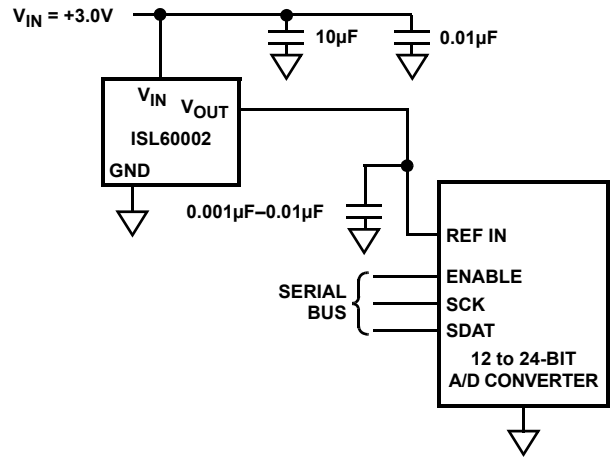

FIGURE 101.

### Board Mounting Considerations

For applications requiring the highest accuracy, board mounting location should be reviewed. Placing the device in areas subject to slight twisting can cause degradation of the accuracy of the reference voltage due to die stresses. It is normally best to place the device near the edge of a board, or the shortest side, as the axis of bending is most limited at that location. Obviously mounting the device on flexprint or extremely thin PC material will likewise cause loss of reference accuracy.

### Noise Performance and Reduction

The output noise voltage in a 0.1Hz to 10Hz bandwidth is typically  $30\mu\text{V}_{\text{P-P}}$ . This is shown in the plot in the Typical Performance Curves. The noise measurement is made with a bandpass filter made of a 1 pole high-pass filter with a corner frequency at 0.1Hz and a 2-pole low-pass filter with a corner frequency at 12.6Hz to create a filter with a 9.9Hz bandwidth. Noise in the 10kHz to 1MHz bandwidth is approximately  $400\mu\text{V}_{\text{P-P}}$  with no capacitance on the output, as shown in Figure 102. These noise measurements are made with a 2 decade bandpass filter made of a 1 pole high-pass filter with a corner frequency at 1/10 of the center frequency and 1-pole low-pass filter with a corner frequency at 10 times the center frequency. Figure 102 also shows the noise in the 10kHz to 1MHz band can be reduced to about  $50\mu\text{V}_{\text{P-P}}$  using a  $0.001\mu\text{F}$  capacitor on the output. Noise in the 1kHz to 100kHz band can be further reduced using a  $0.1\mu\text{F}$  capacitor on the output, but noise in the 1Hz to 100Hz band increases due to instability of the very low power amplifier with a  $0.1\mu\text{F}$  capacitance load. For load capacitances above  $0.001\mu\text{F}$  the noise reduction network shown in Figure 103 is recommended. This network reduces noise significantly over the full bandwidth. As shown in Figure 102, noise is reduced to less than  $40\mu\text{V}_{\text{P-P}}$  from 1Hz to 1MHz using this network with a  $0.01\mu\text{F}$  capacitor and a  $2\text{k}\Omega$  resistor in series with a  $10\mu\text{F}$  capacitor.

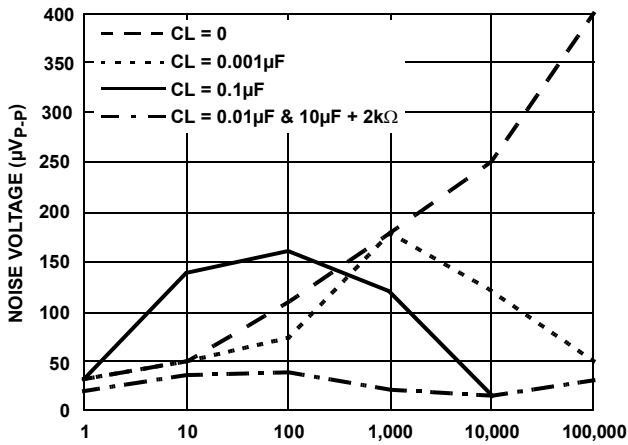

FIGURE 102. NOISE REDUCTION

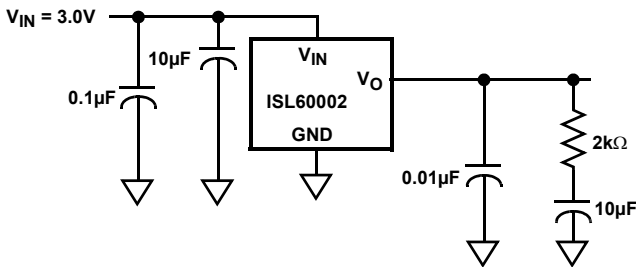
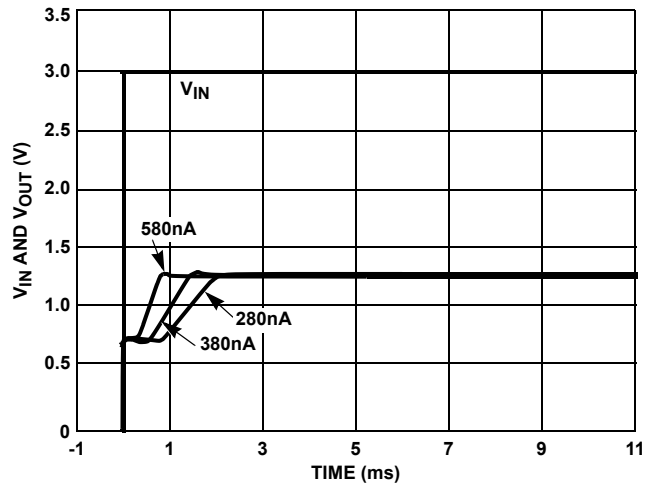

FIGURE 103.

**Turn-On Time**

The ISL60002 devices have ultra-low supply current and thus the time to bias up internal circuitry to final values will be longer than with higher power references. Normal turn-on time is typically 7ms. This is shown in Figure 104. Since devices can vary in supply current down to >300nA, turn-on time can last up to about 12ms. Care should be taken in system design to include this delay before measurements or conversions are started.

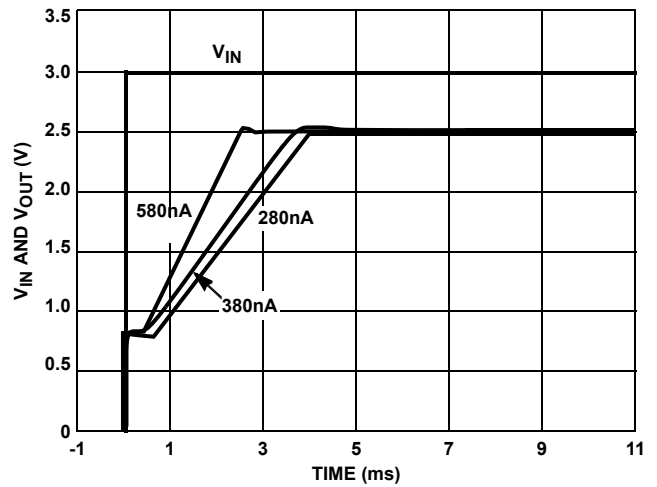

FIGURE 104. TURN-ON TIME

**Temperature Coefficient**

The limits stated for temperature coefficient (tempco) are governed by the method of measurement. The overwhelming standard for specifying the temperature drift of a reference is to measure the reference voltage at two temperatures, take the total variation, ( $V_{HIGH} - V_{LOW}$ ), and divide by the temperature extremes of measurement ( $T_{HIGH} - T_{LOW}$ ). The result is divided by the nominal reference voltage (at  $T = 25^{\circ}C$ ) and multiplied by  $10^6$  to yield ppm/ $^{\circ}C$ . This is the "Box" method for specifying temperature coefficient.

Typical Application Circuits

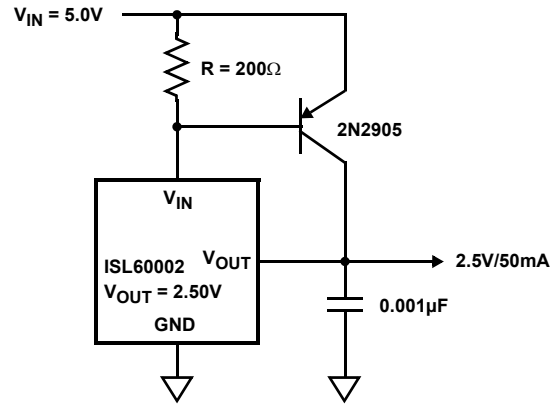

FIGURE 105. PRECISION 2.5V 50mA REFERENCE

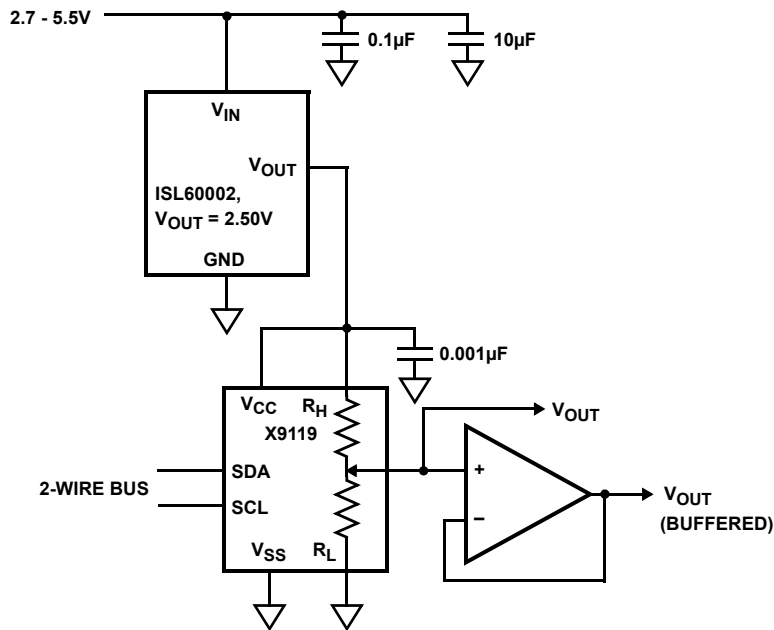

FIGURE 106. 2.5V FULL SCALE LOW-DRIFT 10-BIT ADJUSTABLE VOLTAGE SOURCE

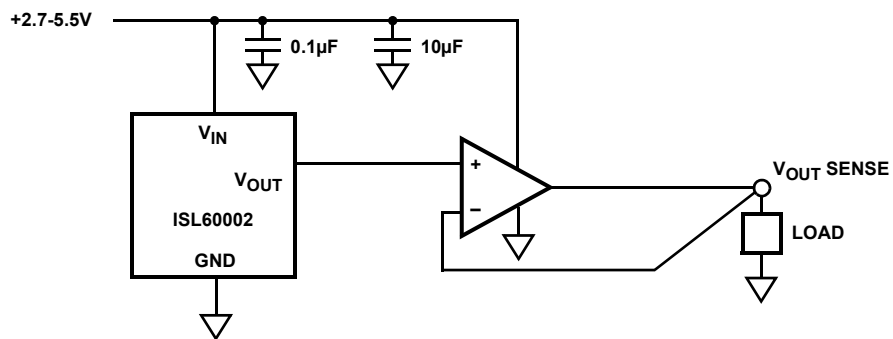
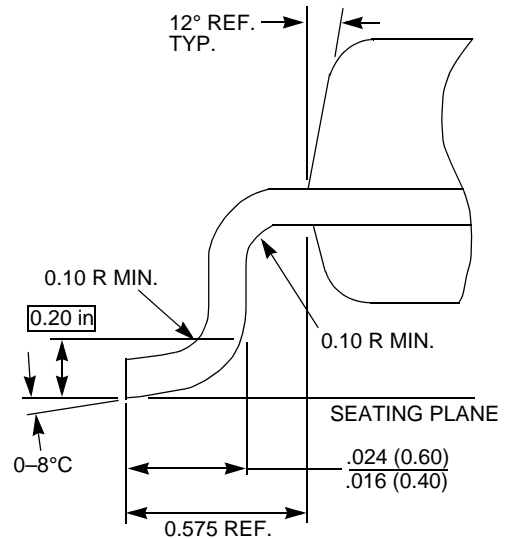
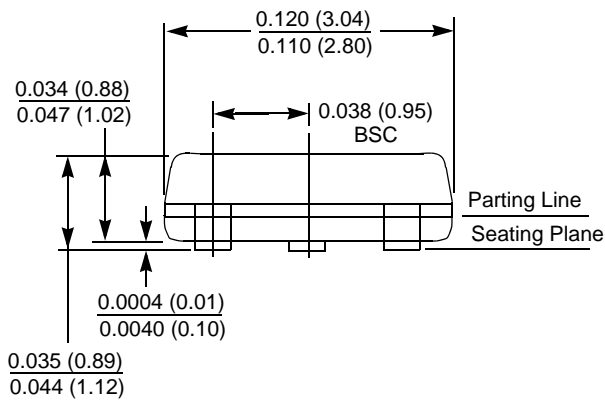
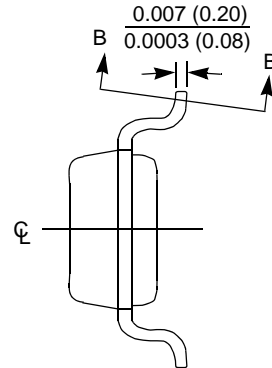
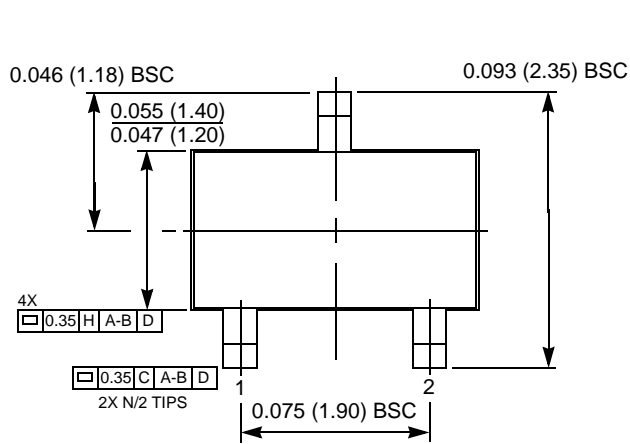

FIGURE 107. KELVIN SENSED LOAD

Packaging Information

3-Lead, SOT-23, Package Code H3



NOTES:

1. All dimensions in inches (in parentheses in millimeters).
2. Package dimensions exclude molding flash.
3. Die and die paddle is facing down towards seating plane.
4. This part is compliant with JEDEC Specification TO-236AB.
5. Dimensioning and tolerances per ASME, Y14.5M-1994.

Packaging Information

8-Lead Plastic, SOIC, Package Code B8

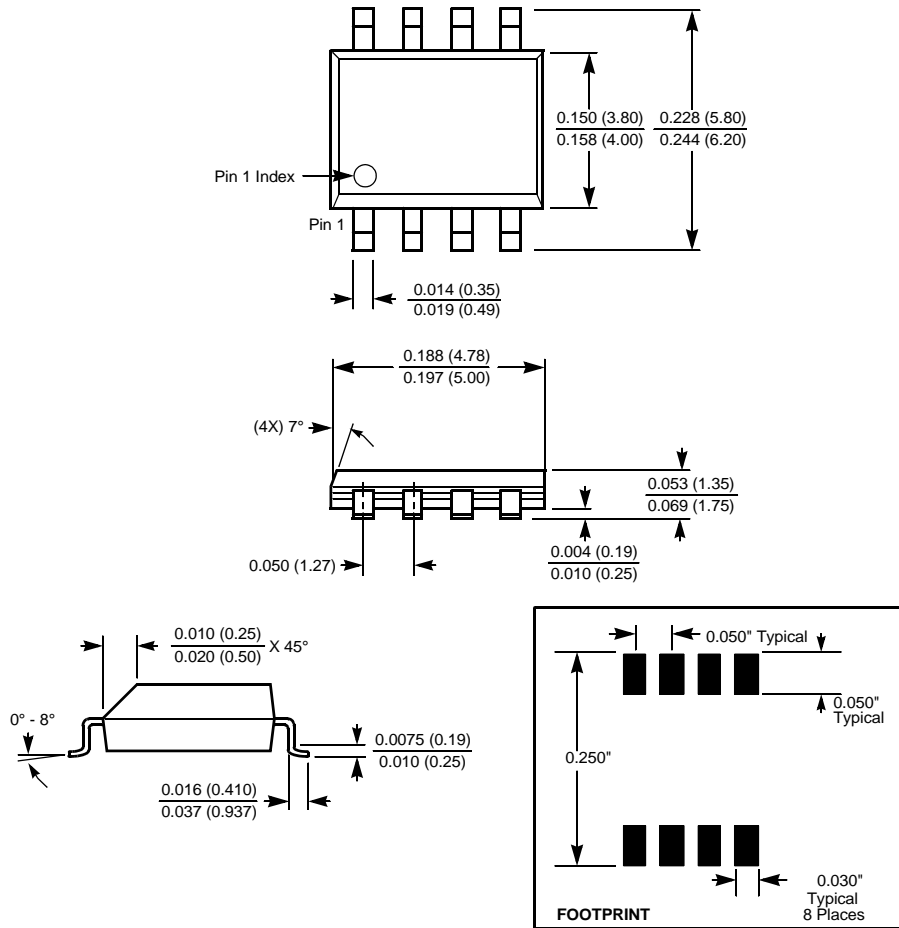

NOTE: All dimensions in inches (in parentheses in millimeters).

All Intersil U.S. products are manufactured, assembled and tested utilizing ISO9000 quality systems. Intersil Corporation's quality certifications can be viewed at [www.intersil.com/design/quality](http://www.intersil.com/design/quality)

*Intersil products are sold by description only. Intersil Corporation reserves the right to make changes in circuit design, software and/or specifications at any time without notice. Accordingly, the reader is cautioned to verify that data sheets are current before placing orders. Information furnished by Intersil is believed to be accurate and reliable. However, no responsibility is assumed by Intersil or its subsidiaries for its use; nor for any infringements of patents or other rights of third parties which may result from its use. No license is granted by implication or otherwise under any patent or patent rights of Intersil or its subsidiaries.*

For information regarding Intersil Corporation and its products, see [www.intersil.com](http://www.intersil.com)