

Amphenol® /Matrix® MIL-C-26482, Series 2 Connectors

12-071-4

Bayonet Coupling, with Crimp Rear Release Contacts



For Military and Industrial Interconnection Applications

Amphenol

This catalog covers the Amphenol® /Matrix® MIL-C-26482, Series 2 Connectors. These connectors are bayonet coupling type, and they feature crimp contacts that are rear insertable and rear releasable. They can be ordered through Amphenol, by military or equivalent proprietary part numbers.

The Matrix® connectors covered in this catalog broaden the miniature cylindrical family offered by Amphenol, so that now users have the broadest range of product available to them. Additional miniature cylindricals are covered in the Amphenol catalog, 12-070, which is available upon request. The 12-070 Amphenol® catalog covers a large variety of miniature cylindricals including the following:

- MIL-C-26482, Series 1 - bayonet coupling connectors with solder contacts
- MIL-C-26482, Series 1 - bayonet coupling connectors with front release crimp contacts
- Other proprietary crimp and solder types including hermetics and connectors with printed circuit board contacts, as well as other shell styles, alternative connector finishes and additional contact options
- Additional miniature cylindricals that have double stub threaded coupling rather than bayonet coupling

See page 15 for more information on these additional miniature cylindrical connector products.

Also, ask for these Amphenol Product Catalogs:
 Amphenol Industrial Connector Brochure, SL-381, for an overview of the industrial family of connectors.
 Amphenol Brochure SL-100, which provides an overview of all products, military and industrial, offered through Amphenol Aerospace.

Should more information be required concerning the connectors covered in this publication, or if special application needs arise, please contact:

Amphenol Corporation
 Amphenol Aerospace
 40-60 Delaware Avenue
 Sidney, New York 13838-1395
 Telephone 607-563-5011
 Fax: 607-563-5157
 Web site: www.Amphenol-Aerospace.com

Visit our website for this catalog and other catalogs of Amphenol products.

| TABLE OF CONTENTS | |
|--|-------|
| Amphenol® /Matrix® MIL-C-26482, Series 2 Connectors | |
| Introduction, Table of Contents | 1 |
| General Description, Features and Benefits | 2 |
| Class Descriptions, Performance Specifications | 3 |
| Shell Styles, Dimensional Data: | |
| Wall Mounting Receptacle, Narrow Flange | 4 |
| Wall Mounting Receptacle, Wide Flange | 5 |
| Cable Connecting Receptacle, | 6 |
| Jam Nut Receptacle | 7 |
| Straight Plug, Straight Plug with RFI Grounding Fingers | 8 |
| Insert Arrangement Chart, Insert Alternate Positions | 9 |
| Insert Arrangement Patterns | 10-12 |
| Contact Information, Sealing Plugs, Crimping and Insertion/Removal Tools | 13 |
| How to Order | 14 |
| Additional MIL-C-26482/Miniature Cylindrical Connectors offered by Amphenol | 15 |
| Sales Office Listing | |

Amphenol Aerospace operates Quality Systems that are Certified to ISO-9001 and AS-9100 by third party Registrars.

Amphenol® /Matrix® Miniature Cylindrical MIL-C-26482, Series 2 Connectors



MS3470
wall mounting receptacle
with narrow flange

MS3472
wall mounting receptacle
with wide flange



MS3471
cable connecting receptacle



MS3474
jam nut receptacle



MS3476
straight plug

MS3475
plug with RFI grounding
fingers

Amphenol broadens their Miniature Cylindrical Family of Connectors with the addition of the Matrix® Product line of MIL-C-26482, Series 2 connectors.

This series provides a bayonet coupling connector with crimp rear insertable, rear releasable contacts.

DESIGN CHARACTERISTICS

- Medium size, environmentally resistant connector
- Recommended operating voltage to 1,000 VAC (RMS) at sea level
- Quick positive coupling assured by 3 point bayonet coupling system
- Visual confirmation of complete coupling
- Eliminates mismatching by the use of five key/keyway design
- Insertion and removal of contacts from the rear of the connector assures no damage to the front that might affect the sealing characteristics
- Utilizes same standard qualified rear-release type plastic tool for contact insertion and removal
- Contacts are qualified to MIL-C-39029 requirements – BIN coded (three color bands), and are crimped with standard crimp tools per MIL-C-22520
- Grommets are constructed of tear-resistant elastomer and experience no degradation when exposed to a broad range of fluids
- Sealing over a range of wire diameters is assured by a triple webbed grommet at the rear of the connector
- Closed entry socket side of the insert is designed with a lead-in chamfer and a hard face that will accept a pin contact bent within pre-established limits
- Elastomer interfacial seal on the pin side has raised barriers around each pin which displace into the socket chamfer when mated, providing a positive moisture seal

CUSTOMER OPTIONS

- Shell styles within this family include:
Wall mount with either a narrow or a wide flange, jam nut single hole mount, and cable connecting receptacles, along with standard plugs or plugs with RFI grounding fingers, in shell sizes 8 to 24
- MS and Proprietary versions available
- Accommodation of contact sizes 20, 16 and 12
- 34 insert arrangement patterns available, accommodating from a minimum of 3 to a maximum of 55 circuits
- Alternate positioning available
- Various finishes are available (for information on non-cadmium zinc alloy plating, consult Amphenol, Sidney, NY)

Amphenol[®]/Matrix[®] Miniature Cylindrical MIL-C-26482, Series 2 Connectors

class descriptions, performance specifications

CLASS DESCRIPTIONS

| Military MIL-C-26482, Series 2 | Amphenol/Matrix Proprietary MB1 Series | Description |
|--------------------------------|--|---|
| Class L | Class R | Aluminum shell, electroless nickel finish, fluid resistant |
| Class E | – | Inactive, superceded by Class L* |
| Class R | – | Inactive, superceded by Class L* |
| Class A | Class A | Aluminum shell, black non-conductive anodized finish, fluid resistant |
| – | Class G | Stainless steel shell, passivated, fluid resistant |
| Class W | Class W | Aluminum shell, olive drab cadmium plated, corrosion/fluid resistant |

* Ref. MIL-C-26482

PERFORMANCE SPECIFICATIONS

SERVICE RATINGS**

| Service Rating | Recommended Operating AC Voltage at Sea Level | Test Voltage AC (RMS), 60 cps | | | |
|----------------|---|-------------------------------|------------|------------|-------------|
| | | Sea Level | 50,000 ft. | 70,000 ft. | 110,000 ft. |
| I | 600 | 1,500 | 500 | 375 | 200 |
| II | 1,000 | 2,300 | 750 | 500 | 200 |

** Service Rating is comparable to MS rating A. Miniature connectors rated Service Rating I will provide a minimum flashover voltage at sea level of 2,000 volts AC (RMS). Service Rating II is comparable to MS Service Rating D, and will provide a minimum flashover voltage of 2,800 volts AC (RMS) at sea level.

Please note that the electrical data given is not an establishment of electrical safety factors. This is left entirely in the designer's hands, as he can best determine which peak voltage, switching surges, transients, etc. can be expected in a particular circuit.

OPERATING TEMPERATURE RANGE

–65°C (–85°F) to 200°C (392°F)

ENVIRONMENTAL SEAL

Wired, mated connectors with the specified accessory attached will meet the altitude immersion test specified in MIL-C-26482.

DURABILITY

Minimum of 500 mating cycles.

SHOCK AND VIBRATION REQUIREMENTS

When tested as follows, the connector shall sustain no physical damage, or electrical discontinuity exceeding one microsecond.

SHOCK:

Pulse of an approximate half sine wave of 300g magnitude with duration of 3 milliseconds applied in three axes.

VIBRATION:

Sixteen hours of random vibration having a range of 50 to 2,000 Hz with a 41.7G peak level.

Miniature Cylindrical MIL-C-26482, Series 2 MS3470 wall mounting receptacle with narrow flange

Receptacle Shell, Wall Mount with Narrow Flange,
Bayonet Coupling

Military No. MS3470
Amphenol/Matrix No. MB10

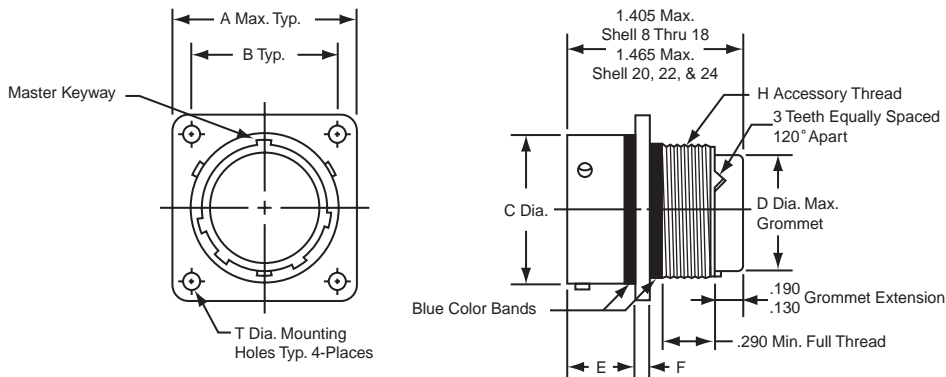

To complete order number see how to order, page 14.

| Shell Size | A Max. | B ±.005 | C Dia. ±.003 | D Dia. Max. | E | F ±.016 | H Accessory Thread Class 2A | T ±.005 |
|------------|--------|---------|--------------|-------------|-----------|---------|-----------------------------|---------|
| 8 | .828 | .594 | .471 | .305 | .462/.431 | .062 | .5000-20 UNF | .120 |
| 10 | .954 | .719 | .588 | .405 | .462/.431 | .062 | .6250-24 UNEF | .120 |
| 12 | 1.047 | .812 | .748 | .531 | .462/.431 | .062 | .7500-20 UNEF | .120 |
| 14 | 1.141 | .906 | .873 | .665 | .462/.431 | .062 | .8750-20 UNEF | .120 |
| 16 | 1.234 | .969 | .998 | .790 | .462/.431 | .062 | 1.0000-20 UNEF | .120 |
| 18 | 1.328 | 1.062 | 1.123 | .869 | .462/.431 | .062 | 1.0625-18 UNEF | .120 |
| 20 | 1.453 | 1.156 | 1.248 | .994 | .587/.556 | .094 | 1.1875-18 UNEF | .120 |
| 22 | 1.578 | 1.250 | 1.373 | 1.119 | .587/.556 | .094 | 1.3125-18 UNEF | .120 |
| 24 | 1.703 | 1.375 | 1.498 | 1.244 | .620/.589 | .094 | 1.4375-18 UNEF | .147 |

Miniature Cylindrical MIL-C-26482, Series 2 MS3472 wall mounting receptacle with wide flange

Receptacle Shell, Wall Mount with Wide Flange,
Bayonet Coupling

Military No. MS3472
Amphenol/Matrix No. MB11

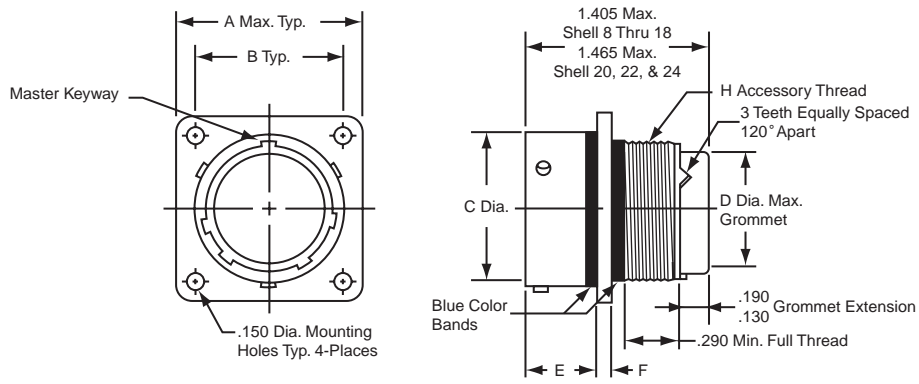

To complete order number see how to order, page 14.

| Shell Size | A Max. | B ±.005 | C Dia. ±.003 | D Dia. Max. | E | F ±.016 | H Thread Class 2A |
|------------|--------|---------|--------------|-------------|-----------|---------|-------------------|
| 8 | 1.065 | .734 | .471 | .305 | .493/.462 | .062 | .5000-20 UNF |
| 10 | 1.141 | .812 | .588 | .405 | .493/.462 | .062 | .6250-24 UNEF |
| 12 | 1.266 | .938 | .748 | .531 | .493/.462 | .062 | .7500-20 UNEF |
| 14 | 1.360 | 1.031 | .873 | .665 | .493/.462 | .062 | .8750-20 UNEF |
| 16 | 1.453 | 1.125 | .998 | .790 | .493/.462 | .062 | 1.0000-20 UNEF |
| 18 | 1.532 | 1.203 | 1.123 | .869 | .493/.462 | .062 | 1.0625-18 UNEF |
| 20 | 1.688 | 1.297 | 1.248 | .994 | .587/.556 | .094 | 1.1875-18 UNEF |
| 22 | 1.766 | 1.375 | 1.373 | 1.119 | .587/.556 | .094 | 1.3125-18 UNEF |
| 24 | 1.891 | 1.500 | 1.498 | 1.244 | .620/.589 | .094 | 1.4375-18 UNEF |

Miniature Cylindrical MIL-C-26482, Series 2 MS3471 cable connecting receptacle

Receptacle Shell, Cable Connecting, Bayonet Coupling

Military No. MS3471
Amphenol/Matrix No. MB13

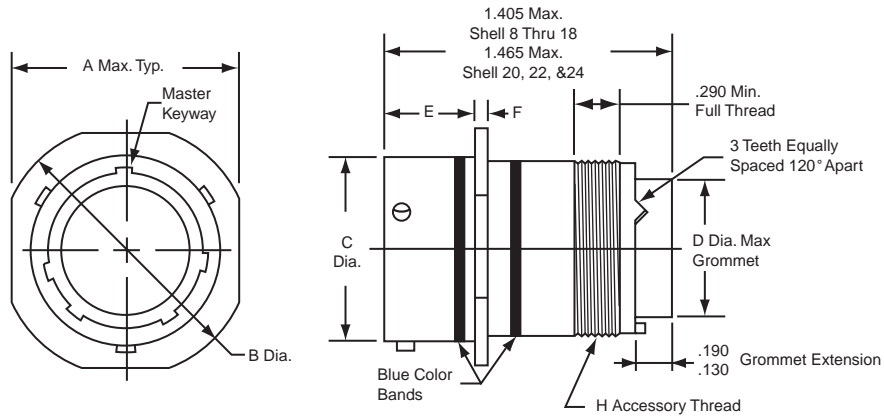

To complete order number see how to order, page 14.

| Shell Size | A Max. | B Dia. ±.020 | C Dia. ±.003 | D Dia. Max. | E | F ±.016 | H Thread Class 2A |
|------------|--------|--------------|--------------|-------------|-----------|---------|-------------------|
| 8 | .828 | .938 | .471 | .305 | .462/.431 | .062 | .5000-20 UNF |
| 10 | .954 | 1.062 | .588 | .405 | .462/.431 | .062 | .6250-24 UNEF |
| 12 | 1.047 | 1.156 | .748 | .531 | .462/.431 | .062 | .7500-20 UNEF |
| 14 | 1.141 | 1.250 | .873 | .665 | .462/.431 | .062 | .8750-20 UNEF |
| 16 | 1.234 | 1.344 | .998 | .790 | .462/.431 | .062 | 1.0000-20 UNEF |
| 18 | 1.328 | 1.438 | 1.123 | .869 | .462/.431 | .062 | 1.0625-18 UNEF |
| 20 | 1.453 | 1.562 | 1.248 | .994 | .587/.556 | .094 | 1.1875-18 UNEF |
| 22 | 1.578 | 1.688 | 1.373 | 1.119 | .587/.556 | .094 | 1.3125-18 UNEF |
| 24 | 1.703 | 1.812 | 1.498 | 1.244 | .620/.589 | .094 | 1.4375-18 UNEF |

Miniature Cylindrical MIL-C-26482, Series 2 MS3474 jam nut receptacle

Receptacle Shell, Jam Nut Mount,
Bayonet Coupling

Military No. MS3474

Amphenol/Matrix No. MB14

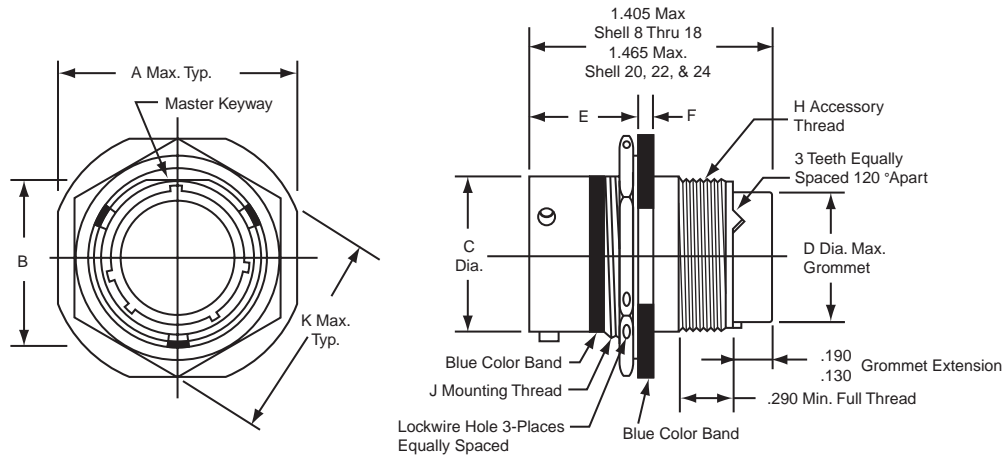

To complete order number see how to order, page 14.

| Shell Size | A Max. | B ±.005 | C Dia. ±.003 | D Dia. Max. | E | F | H Accessory Thread Class 2A | J Mounting Thread Class 2A | K Max. |
|------------|--------|---------|--------------|-------------|-----------|-----------|-----------------------------|----------------------------|--------|
| 8 | .954 | .525 | .471 | .305 | .707/.658 | .113/.086 | .5000-20 UNF | .5625-24 UNEF | .767 |
| 10 | 1.078 | .650 | .588 | .405 | .707/.658 | .113/.086 | .6250-24 UNF | .6875-24 UNEF | .892 |
| 12 | 1.266 | .813 | .748 | .531 | .707/.658 | .113/.086 | .7500-20 UNEF | .8750-20 UNEF | 1.079 |
| 14 | 1.391 | .937 | .873 | .665 | .707/.658 | .113/.086 | .8750-20 UNEF | 1.0000-20 UNEF | 1.205 |
| 16 | 1.516 | 1.061 | .998 | .790 | .707/.658 | .113/.086 | 1.0000-20 UNEF | 1.1250-18 UNEF | 1.329 |
| 18 | 1.641 | 1.186 | 1.123 | .869 | .707/.658 | .113/.086 | 1.0625-18 UNEF | 1.2500-18 UNEF | 1.455 |
| 20 | 1.828 | 1.311 | 1.248 | .994 | .772/.721 | .148/.096 | 1.1875-18 UNEF | 1.3750-18 UNEF | 1.579 |
| 22 | 1.954 | 1.436 | 1.373 | 1.119 | .772/.721 | .148/.096 | 1.3125-18 UNEF | 1.5000-18 UNEF | 1.705 |
| 24 | 2.078 | 1.561 | 1.498 | 1.244 | .772/.721 | .148/.096 | 1.4375-18 UNEF | 1.6250-18 UNEF | 1.829 |

Miniature Cylindrical MIL-C-26482, Series 2

MS3476 straight plug

MS3475 straight plug with RFI grounding fingers

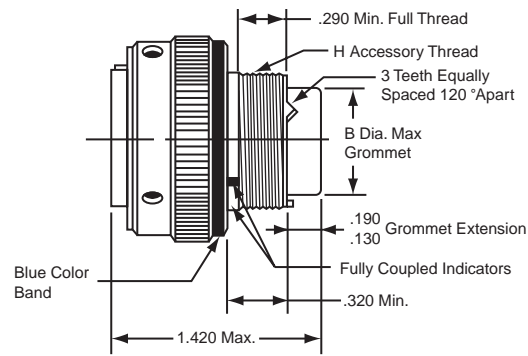
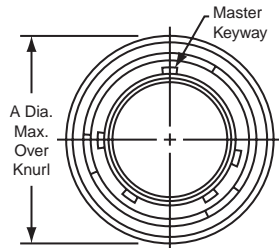

**Plug Shell,
Bayonet Coupling**
Military No. MS3476
Amphenol/Matrix No. MB16

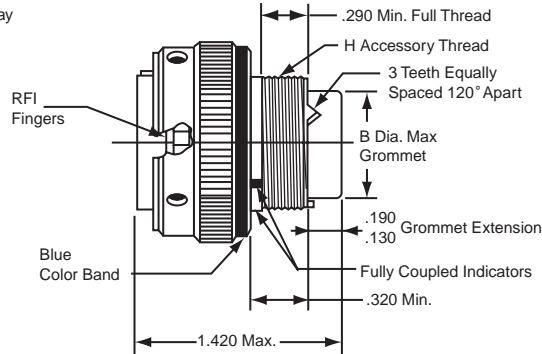
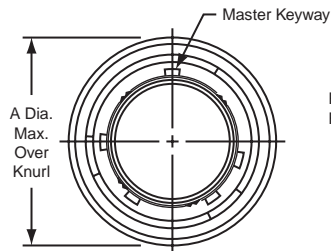

**Plug Shell, RFI Grounding,
Bayonet Coupling**
Military No. MS3475
Amphenol/Matrix No. MB18

To complete order number see how to order, page 14.

| Shell Size | A Dia. Max. | B Dia. Max. | H Accessory Thread Class 2A |
|------------|-------------|-------------|-----------------------------|
| 8 | .782 | .305 | .5000-20 UNF |
| 10 | .926 | .405 | .6250-24 UNEF |
| 12 | 1.043 | .531 | .7500-20 UNEF |
| 14 | 1.183 | .665 | .8750-20 UNEF |
| 16 | 1.305 | .790 | 1.0000-20 UNEF |
| 18 | 1.391 | .869 | 1.0625-18 UNEF |
| 20 | 1.531 | .994 | 1.1875-18 UNEF |
| 22 | 1.656 | 1.119 | 1.3125-18 UNEF |
| 24 | 1.777 | 1.244 | 1.4375-18 UNEF |

Miniature Cylindrical MIL-C-26482, Series 2 insert arrangements, insert alternate positioning

INSERT ARRANGEMENTS

| Insert Arrangement | Service Rating | Total Contacts | Contact Size | | |
|--------------------|----------------|----------------|--------------|----|----|
| | | | 12 | 16 | 20 |
| 8-33 | I | 3 | | | 3 |
| 8-98 | I | 3 | | | 3 |
| 10-6 | I | 6 | | | 6 |
| 12-3 | II | 3 | | 3 | |
| 12-8 | I | 8 | | | 8 |
| 12-10 | I | 10 | | | 10 |
| 14-4 | I | 4 | 4 | | |
| 14-5 | II | 5 | | 5 | |
| 14-9S | I | 9 | 4 | | 5 |
| 14-12 | I | 12 | | 4 | 8 |
| 14-15 | I | 15 | | 1 | 14 |
| 14-18 | I | 18 | | | 18 |
| 14-19 | I | 19 | | | 19 |
| 16-8 | II | 8 | | 8 | |
| 16-23S | I | 23 | | 1 | 22 |
| 16-26 | I | 26 | | | 26 |
| 18-8 | I | 8 | 8 | | |
| 18-11S | II | 11 | | 11 | |
| 18-30S | I | 30 | | 1 | 29 |
| 18-32 | I | 32 | | | 32 |
| 20-16 | II | 16 | | 16 | |
| 20-24S | I | 24 | | | 24 |
| 20-39 | I | 39 | | 2 | 37 |
| 20-41 | I | 41 | | | 41 |
| 22-12S | I | 12 | 12 | | |
| 22-19S | I | 19 | 19 | | |
| 22-21 | II | 21 | | 21 | |
| 22-32S | I | 32 | | | 32 |
| 22-41 | I | 41 | | 14 | 27 |
| 22-55 | I | 55 | | | 55 |
| 22-95S | I | 32 | 6 | | 26 |
| 24-19S | II | 19 | 19 | | |
| 24-31 | I | 31 | | 31 | |
| 24-61 | I | 61 | | | 61 |

Arrangements designated with an S are tooled in socket only.

INSERT ALTERNATE POSITIONING

To avoid cross-plugging problems in applications requiring the use of more than one connector of the same size and arrangement, alternate rotations are available as indicated in the chart below.

As shown in the diagram, the front face of the pin insert is rotated within the shell in a clockwise direction from the normal shell key. The socket insert would be rotated counter-clockwise the same number of degrees in respect to the normal shell key.

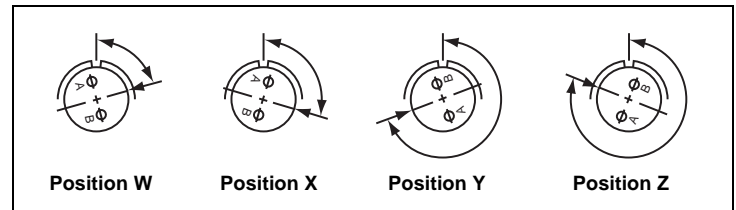



View looking into front face of pin insert or rear of socket insert.

| Insert Arrangement | Degrees | | | |
|--------------------|---------|-----|-----|-----|
| | W | X | Y | Z |
| 8-33 | 90 | - | - | - |
| 8-98 | - | - | - | - |
| 10-6 | 90 | - | - | - |
| 12-3 | - | - | 180 | - |
| 12-8 | 90 | 112 | 203 | 292 |
| 12-10 | 60 | 155 | 270 | 295 |
| 14-4 | 45 | - | - | - |
| 14-5 | 40 | 92 | 184 | 273 |
| 14-9 | 15 | 90 | 180 | 270 |
| 14-12 | 43 | 90 | - | - |
| 14-15 | 17 | 110 | 155 | 234 |
| 14-18 | 15 | 90 | 180 | 270 |
| 14-19 | 30 | 165 | 315 | - |
| 16-8 | 54 | 152 | 180 | 331 |
| 16-23 | 158 | 270 | - | - |
| 16-26 | 60 | - | 275 | 338 |
| 18-8 | 180 | - | - | - |
| 18-11 | 62 | 119 | 241 | 340 |
| 18-30 | 180 | 193 | 285 | 350 |
| 18-32 | 85 | 138 | 222 | 265 |
| 20-16 | 238 | 318 | 333 | 347 |
| 20-24 | 70 | 145 | 215 | 290 |
| 20-39 | 63 | 144 | 252 | 333 |
| 20-41 | 45 | 126 | 225 | - |
| 22-12 | - | - | - | - |
| 22-19 | 15 | 90 | 225 | 308 |
| 22-21 | 16 | 135 | 175 | 349 |
| 22-32 | 72 | 145 | 215 | 288 |
| 22-41 | 39 | 135 | 264 | - |
| 22-55 | 30 | 142 | 226 | 314 |
| 22-95 | 26 | 180 | 266 | - |
| 24-19 | 30 | 165 | 315 | - |
| 24-31 | 90 | 225 | 255 | - |
| 24-61 | 90 | 180 | 270 | 324 |

Miniature Cylindrical MIL-C-26482, Series 2 contact arrangements

front face of pin insert or rear face of socket insert illustrated

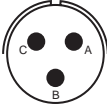
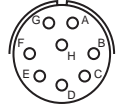
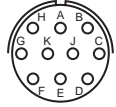
| | | | | | | |
|---------------------------|---|---|---|--|---|---|
| |  |  |  |  |  |  |
| Insert Arrangement | 8-33 | 8-98 | 10-06 | 12-03 | 12-08 | 12-10 |
| Service Rating | I | I | I | II | I | I |
| Number of Contacts | 3 | 3 | 6 | 3 | 8 | 10 |
| Contact Size | 20 | 20 | 20 | 16 | 20 | 20 |

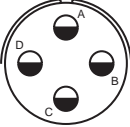
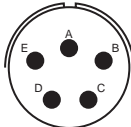
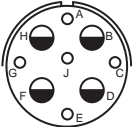
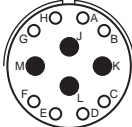
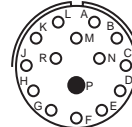
| | | | | | |
|---------------------------|--|--|--|--|--|
| |  |  |  |  |  |
| Insert Arrangement | 14-04 | 14-05 | 14-09 | 14-12 | 14-15 |
| Service Rating | I | II | I | I | I |
| Number of Contacts | 4 | 5 | 5 4 | 8 4 | 14 1 |
| Contact Size | 12 | 16 | 20 12 | 20 16 | 20 16 |

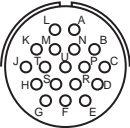
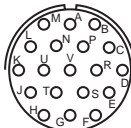
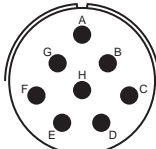
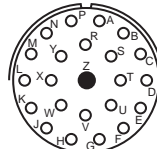
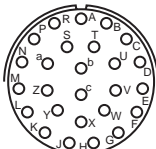
| | | | | | |
|---------------------------|---|---|---|---|---|
| |  |  |  |  |  |
| Insert Arrangement | 14-18 | 14-19 | 16-08 | 16-23 | 16-26 |
| Service Rating | I | I | II | I | I |
| Number of Contacts | 18 | 19 | 8 | 22 1 | 26 |
| Contact Size | 20 | 20 | 16 | 20 16 | 20 |

CONTACT LEGEND ○ ● ◐
 20 16 12

Miniature Cylindrical MIL-C-26482, Series 2 contact arrangements

front face of pin insert or rear face of socket insert illustrated

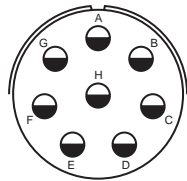

18-08

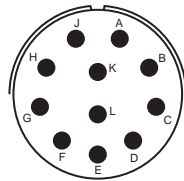

18-11

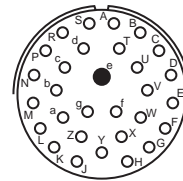

18-30

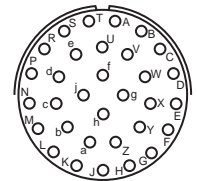

18-32

Insert Arrangement
Service Rating
Number of Contacts
Contact Size

I
8
12

II
11
16

I
29 1
20 16

I
32
20

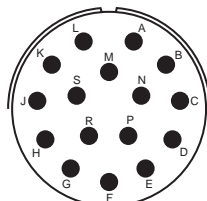

20-16

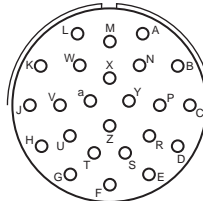

20-24

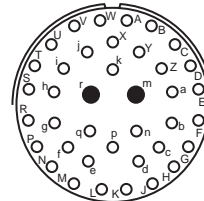

20-39

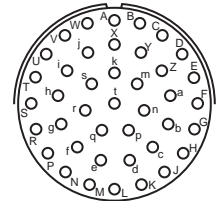

20-41

Insert Arrangement
Service Rating
Number of Contacts
Contact Size

II
16
16

I
24
20

I
37 2
20 16

I
41
20

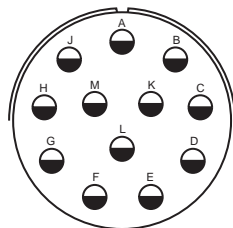

22-12

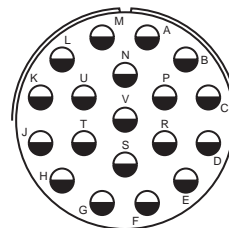

22-19

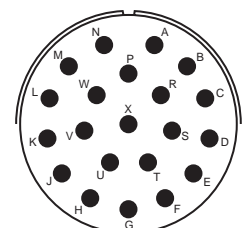

22-21

Insert Arrangement
Service Rating
Number of Contacts
Contact Size

I
12
12

I
19
12

II
21
16

CONTACT LEGEND



Miniature Cylindrical MIL-C-26482, Series 2 contact arrangements

front face of pin insert or rear face of socket insert illustrated

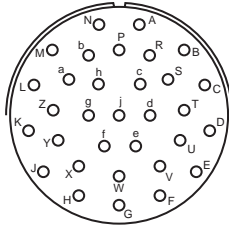

Insert Arrangement 22-32
Service Rating I
Number of Contacts 32
Contact Size 20

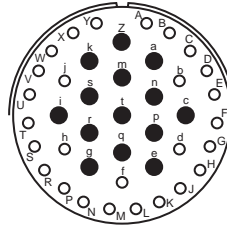

22-41
Service Rating I
Number of Contacts 27 14
Contact Size 20 16

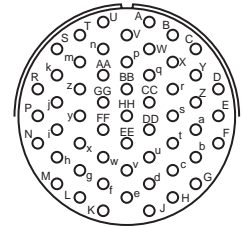

22-55
Service Rating I
Number of Contacts 55
Contact Size 20

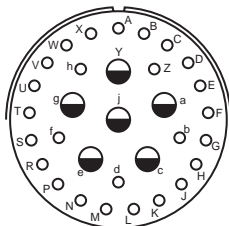

Insert Arrangement 22-95
Service Rating I
Number of Contacts 26 6
Contact Size 20 12

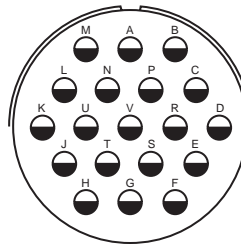

24-19
Service Rating II
Number of Contacts 19
Contact Size 12

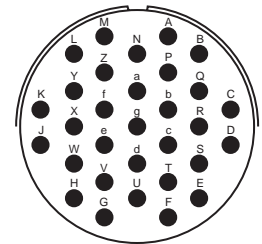

24-31
Service Rating I
Number of Contacts 31
Contact Size 16

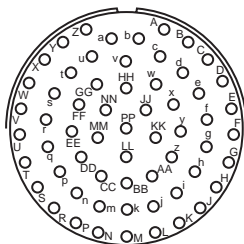

Insert Arrangement 24-61
Service Rating I
Number of Contacts 61
Contact Size 20

CONTACT LEGEND ○ ● ◐
 20 16 12

Miniature Cylindrical MIL-C-26482, Series 2 contact information, sealing plugs, crimping and insertion/removal tools

MIL-C-26482, SERIES 2 CRIMP CONTACTS

| Contact Size | Wire Range | | Socket Contacts | | Pin Contacts | |
|--------------|------------|-----------------|----------------------|-----------------------------|----------------------|-----------------------------|
| | AWG | mm ² | Military Part Number | Amphenol/Matrix Part Number | Military Part Number | Amphenol/Matrix Part Number |
| 20 | 24-20 | 0.2-0.6 | M39029/5-115 | M5100-001-0020L | M39029/4-110 | M5000-054-0020L |
| 16 | 20-16 | 0.5-1.4 | M39029/5-116 | M5100-001-0016L | M39029/4-111 | M5000-054-0016L |
| 12 | 14-12 | 2-3 | M39029/5-118 | M5100-001-0012L | M39029/4-113 | M5000-054-0012L |

CONTACT CURRENT RATING AND RETENTION

| Contact Size* | DC Test Amperage | Contact Retention | |
|---------------|------------------|-------------------|-------|
| | | Axial Load | |
| | | lb. | N |
| 20 | 7.5 | 15 | 66.7 |
| 16 | 13.0 | 25 | 111.2 |
| 12 | 23.0 | 30 | 133.4 |

* Organize individual circuits to maintain heat rise within operating temperature requirements.

SEALING PLUGS

| Contact Size | Sealing Plugs | |
|--------------|----------------------|-----------------------------|
| | Military Part Number | Amphenol/Matrix Part Number |
| 20 | MS27488-20 | 10-405996-020 |
| 16 | MS27488-16 | 10-405996-016 |
| 12 | MS27488-12 | 10-405996-012 |

CRIMPING TOOLS

| Contact Size | Wire Range | | Finished Wire Dia. Range | | Crimping Tool Part Number | Turret or Positioner Part Number |
|--------------|------------|-----------------|--------------------------|-----------|----------------------------|----------------------------------|
| | AWG | mm ² | Inch | mm | | |
| 20 | 24-20 | 0.2-0.6 | .040-.083 | 1.02-2.11 | M22520/1-01 or M22520/2-01 | M22520/1-02 or M22520/2-02 |
| 16 | 20-16 | 0.5-1.4 | .053-.103 | 1.34-2.62 | M22520/1-01 | M22520/1-02 |
| 12 | 14-12 | 2-3 | .097-.158 | 2.46-4.01 | M22520/1-01 | M22520/1-02 |

INSERTION/REMOVAL TOOLS

| Contact Size | Color Code | Military Part Number | Amphenol/Matrix Part Number |
|--------------|--------------|----------------------|-----------------------------|
| 20 | Red/White | M81969/14-11 | 10-538988-021 |
| 16 | Blue/White | M81969/14-03 | 10-538988-016 |
| 12 | Yellow/White | M81969/14-04 | 10-538988-012 |

Note: Each connector is furnished with contacts. One spare for inserts requiring 1 to 26 of each contact, two spares for inserts with more than 26 contacts, and a minimum of one sealing plug up to 15% of the number of contacts.

MIL-C-26482, Series 2

how to order

HOW TO ORDER BY MILITARY PART NUMBER MIL-C-26482 SERIES 2 CONNECTORS

| | | | | | | |
|-----------|-------------|----------|-----------|-----------|----------|----------|
| <u>MS</u> | <u>3470</u> | <u>W</u> | <u>12</u> | <u>10</u> | <u>P</u> | <u>W</u> |
| 1 | 2 | 3 | 4 | 5 | 6 | 7 |

1. Connector Type
MS designates Military Standard
2. Connector Style
 - 3470 wall mounting receptacle with narrow flange
 - 3472 wall mounting receptacle with wide flange
 - 3471 cable connecting receptacle
 - 3474 jam nut receptacle
 - 3476 straight plug
 - 3475 straight plug with RFI grounding fingers
3. Service Class
 - L aluminum shell, electroless nickel finish, fluid resistant insert
 - A aluminum shell, black anodized finish, non-conductive fluid resistant insert
 - W aluminum shell, olive drab cadmium plated, fluid resistant insert

Note: For stainless steel shell, passivated, order by Amphenol®/Matrix® proprietary Class G.
Class L inactivates older classes E and R (Ref. MIL-C-26482)
- 4., 5. Shell size and insert arrangement - See chart on page 9 and pattern drawings that follow.
6. Contact Types
 - P designates pin
 - S designates socket
 - A designates less pins
 - B designates less sockets

Note: Use A & B only when other than a full complement of power contacts is to be installed.
7. Insert Rotation
"W", "X", "Y", "Z" designate that insert is rotated in its shell from normal position. No letter required for normal (no rotation) position. See page 9 for description of alternate positions.

HOW TO ORDER BY PROPRIETARY PART NUMBER MIL-C-26482 SERIES 2 CONNECTORS

| | | | | | | | |
|------------|----------|----------|-----------|-----------|----------|----------|------------|
| <u>MB1</u> | <u>0</u> | <u>W</u> | <u>12</u> | <u>10</u> | <u>P</u> | <u>W</u> | <u>***</u> |
| 1 | 2 | 3 | 4 | 5 | 6 | 7 | 8 |

1. Connector Type
MB1 designates Amphenol®/Matrix® Bayonet Coupling Connector
2. Connector Style
 - 0 wall mounting receptacle with narrow flange
 - 1 wall mounting receptacle with wide flange
 - 3 cable connecting receptacle
 - 4 jam nut receptacle
 - 6 straight plug
 - 8 straight plug with RFI grounding fingers
3. Service Class
 - A aluminum shell, black anodize finish, non-conductive, fluid resistant insert
 - R aluminum shell, electroless nickel finish, fluid resistant insert
 - G stainless steel shell, passivated, fluid resistant insert
 - W aluminum shell, cadmium plated, olive drab finish, fluid resistant insert
- 4., 5. Shell size and insert arrangement - See chart on page 9 and pattern drawings that follow.
6. Contact Types
 - P designates pin
 - S designates socket
7. Insert Rotation
"W", "X", "Y", "Z" designate that insert is rotated in its shell from normal position. No letter required for normal (no rotation) position. See page 9 for description of alternate positions.
8. Modification Number
Consult Amphenol, Sidney, NY for information.
For strain reliefs use the following modification codes:
(189) E-nut M85049/31 configuration
(190) Straight strain relief M85049/52 configuration
(191) 90° strain relief M85049/51 configuration

For ordering information on accessories, such as protection caps and backshell hardware, contact Amphenol, Sidney, NY.

Additional Miniature Cylindrical Connectors offered by Amphenol



Miniature Cylindrical Proprietary/MIL-C-26482, Series 1 & 2 Connectors

There are several additional connector series within the Amphenol® MIL-C-26482 and similar types family. Each series offers varying design characteristics and customer options to meet cost considerations and to provide users with the most design flexibility possible.

The additional series within the Amphenol Miniature Cylindrical Family of Connectors are shown in detail in Amphenol catalog 12-070, which can be supplied upon request. Briefly these additional products are described as follows:

- **PT, SP, MS/PT**

- **Proprietary/MIL-C-26482, Series 1**

- These are bayonet type with solder contacts. Both the insert and main joint gasket are molded from resilient neoprene. This provides excellent moisture sealing at the gasket and superior electrical isolation of the contact in the inserts.

- Socket contacts are closed entry design. Printed circuit board contacts are also available in this series.

- The SP is a modification of the PT providing special shells with a wide mounting flange for back panel mounting. The SP also has a durable non-conductive hard anodic "Alumi-lite" coating which provides abrasion and corrosion protection.

- There are 8 shell styles in the PT, SP and MS/PT series, and shell sizes are 6-24. The PT solder is UL recognized. Hermetics are also available.

- **PT-SE, SP-SE, MS/PT-SE**

- **Proprietary/MIL-C-26482, Series 1**

- These are a derivative of the PT line, bayonet type. However, they incorporate crimp contacts that are rear insertable, front releasable. An MS approved spring tower retention system holds the contacts in place.

- **PT-CE, SP-CE**

- **Proprietary crimp type**

- Another derivative of the PT line, bayonet type. These also have crimp contacts that are rear insertable, front releasable, but the contacts are held in place by a nylon wafer retention system. The voidless one-piece insert and grommet assembly provide continuous dielectric separation between contacts.

- **PC, PC-SE, PC-CE**

- **Proprietary solder and crimp type**

- The PC series within the Amphenol® miniature cylindrical family is threaded coupling, rather than bayonet coupling. The threads are double-stubbed so they can not be cross threaded.

- The PC is offered with solder contacts. The PC-SE has crimp contacts in a spring tower retention system, while the PC-CE has crimp contacts in a nylon wafer retention system. Hermetics are available

All miniature cylindricals are intermateable and intermountable with each other except for the threaded coupling PC Series.

For further information ask for catalog 12-070. Consult Amphenol, Sidney, NY for any assistance on these products or for any specific application needs.

Mouser Electronics

Authorized Distributor

Click to View Pricing, Inventory, Delivery & Lifecycle Information:

[Amphenol:](#)

[M39029/5-118](#) [M39029/5-115](#) [M5100-001-0020L](#) [M39029/4-113](#) [M39029/5-116](#)