

## Transient Voltage Suppressors Array for ESD Protection

### ESDXXV23T-2LC Series

#### Description

The ESDXXV23T-2LC is designed to protect voltage sensitive components from ESD and transient voltage events. Excellent clamping capability, low leakage, and fast response time, make these parts ideal for ESD protection on designs where board space is at a premium.

#### SOT-23

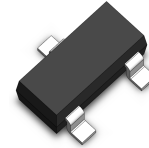

#### Feature

- u 100 Watts Peak Pulse Power per Line (tp=8/20μs)
- u Protects two bidirectional I/O lines
- u Low clamping voltage
- u Working voltages : 3.3V and 5V
- u Low leakage current
- u IEC61000-4-2 (ESD) ±15kV (air), ±8kV (contact)
- u IEC61000-4-4 (EFT) 40A (5/50ns)

#### Functional Diagram

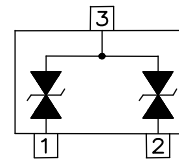

#### Applications

- u Cell Phone Handsets and Accessories
- u Microprocessor based equipment
- u Industrial Controls
- u Notebooks, Desktops, and Servers
- u Set-Top Box
- u Peripherals

#### Mechanical Characteristics

- u JEDEC SOT-23 Package
- u Molding Compound Flammability Rating : UL 94V-0
- u Weight 8.0 Milligrams (Approximate)
- u Quantity Per Reel : 3,000pcs
- u Reel Size : 7 inch
- u Lead Finish : Lead Free

#### Mechanical Characteristics

Symbol	Parameter	Value	Units
P <sub>PP</sub>	Peak Pulse Power (tp=8/20μs waveform)	100	W
T <sub>L</sub>	Lead Soldering Temperature	260 (10sec)	°C
T <sub>STG</sub>	Storage Temperature Range	-55 to +150	°C
T <sub>J</sub>	Operating Temperature Range	-55 to +150	°C
	IEC61000-4-2 (ESD)	Air Discharge ±15 Contact Discharge ±8	KV
	IEC61000-4-4 (EFT)	40	A

## Transient Voltage Suppressors Array for ESD Protection

### ESDXXV23T-2LC Series

Electrical Characteristics (@ 25°C Unless Otherwise Specified)

Part Number	Device Marking	V <sub>RWM</sub> (V) (Max.)	V <sub>B</sub> (V) (Min.)	I <sub>T</sub> (mA)	V <sub>C</sub> @1A (Max.)	V <sub>C</sub>		I <sub>R</sub> (μA) (Max.)	C (pF) (Typ.)
						(Max.)	(@A)		
ESD3.3V23T-2LC	L33	3.3	4.5	1	6	12	2.5	10	12
ESD05V23T-2LC	L50	5	6	1	9.8	15	2.5	1	10

### Characteristic Curves

Fig1. 8/20μs Pulse Waveform

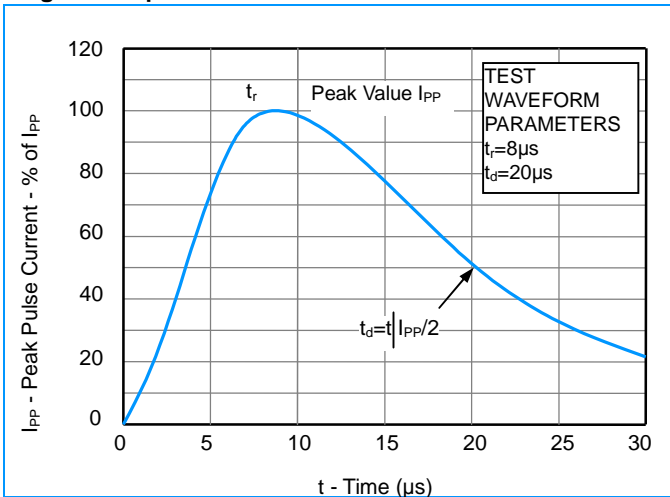

Fig2. ESD Pulse Waveform (according to IEC 61000-4-2)

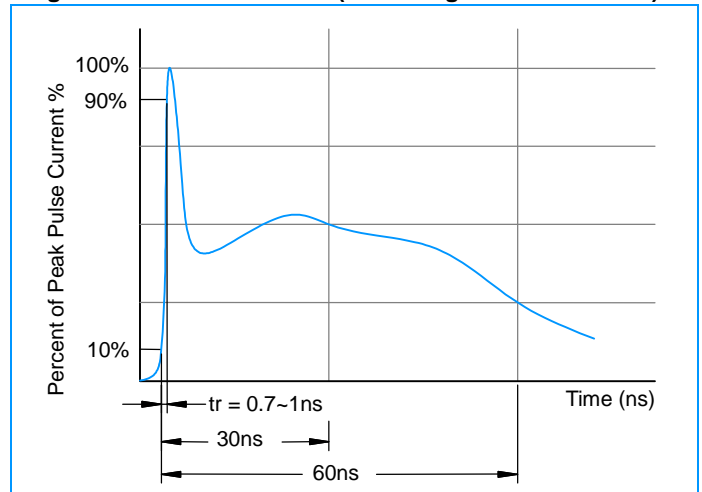
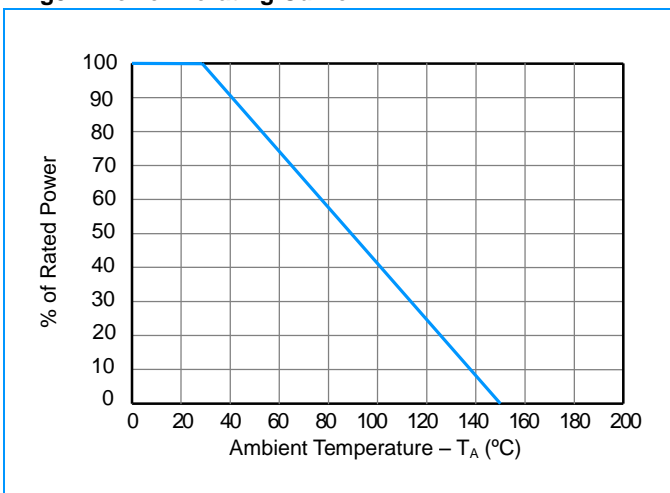

Fig3. Power Derating Curve



## Transient Voltage Suppressors Array for ESD Protection

### ESDXXV23T-2LC Series

#### SOT-23 Package Outline & Dimensions

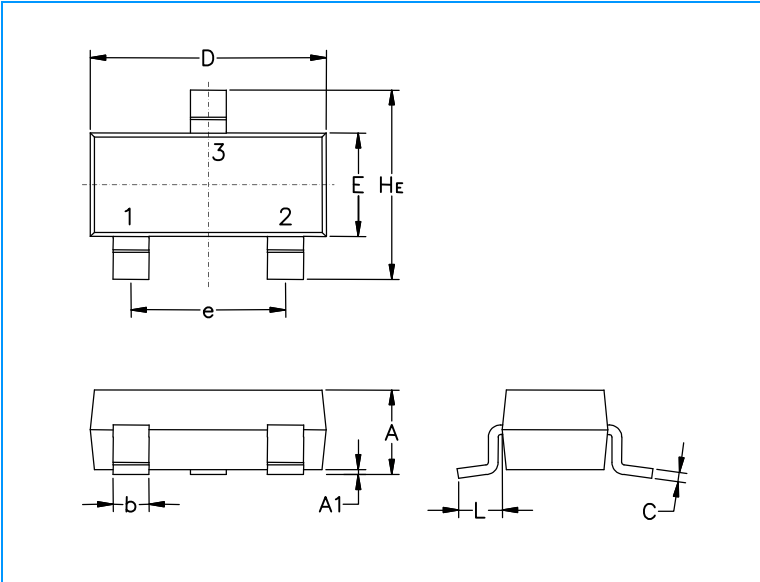

Symbol	Millimeters			Inches		
	Min.	Nom.	Max.	Min.	Nom.	Max.
<b>A</b>	0.89	1.00	1.11	0.035	0.040	0.044
<b>A1</b>	0.01	0.06	0.10	0.001	0.002	0.004
<b>b</b>	0.37	0.44	0.50	0.15	0.18	0.020
<b>c</b>	0.09	0.13	0.18	0.003	0.005	0.007
<b>D</b>	2.80	2.90	3.04	0.110	0.114	0.120
<b>E</b>	1.20	1.30	1.40	0.047	0.051	0.055
<b>e</b>	1.78	1.90	2.04	0.070	0.075	0.081
<b>L</b>	0.35	0.54	0.69	0.014	0.021	0.029
<b>He</b>	2.10	2.40	2.64	0.083	0.094	0.104

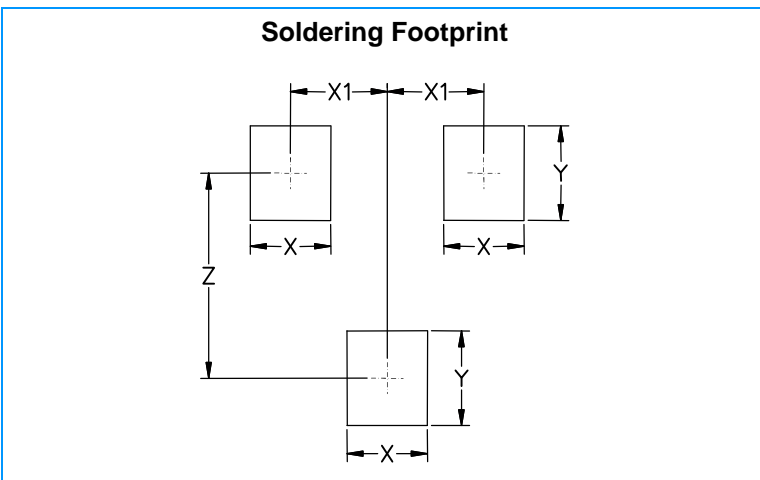

Symbol	Millimeters	Inches
<b>X</b>	0.80	0.031
<b>X1</b>	0.95	0.037
<b>Y</b>	0.90	0.035
<b>Z</b>	2.00	0.079